

FILM CAPACITORS

PRODUCT SPECIFICATIONS

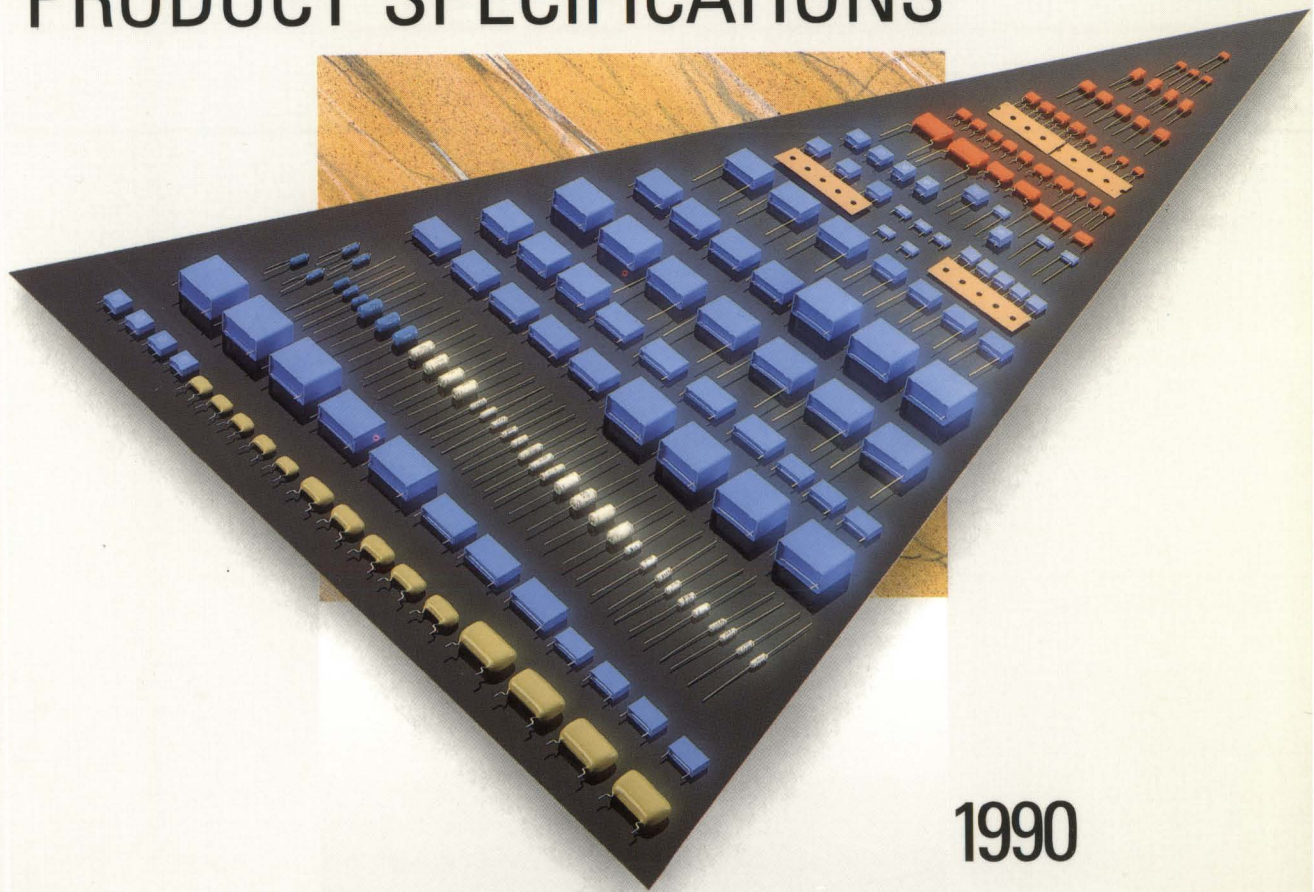

1990

Philips Components



PHILIPS

CONTENTS

Introduction	3
Selection guide	9
Product data	
General purpose.....	23
Interference suppression.....	131
AC and pulse.....	187
Precision.....	265
Specials.....	339
Maintenance.....	429

Introduction

INTRODUCTION

General

As can be seen in the selection guide, capacitors for design purposes are categorized under five main headings. There is also a maintenance classification under which types about to be, or already replaced by newer types are grouped. This group is located at the back of the book, and no inspection requirements data is included.

Listed below are two sets of definitions of terms; the first set is used in the general data section and the second set used in the inspection requirements section of each type. Further detail can be obtained by reference to the relevant IEC publication (IEC 68 and IEC 384).

General definitions

Type

A group of film capacitors having similar features and a similarity of manufacturing techniques which enables them to be grouped together.

Style

A sub-division of **type**, generally of a mechanical order.

Capacitance

Is the capacitance value for which the capacitor has been designed and which is usually indicated upon it.

Rated voltage (U_R)

The maximum direct voltage or peak value of pulse voltage which may be applied continuously to a capacitor at its upper category temperature.

Category voltage (U_C)

The maximum voltage which may be applied continuously to a capacitor at its upper category temperature.

Climatic category

The climatic code (e.g. 50/100/56) indicates which climatic category a film capacitor type belongs to.

The category is indicated by a series of three sets of digits separated by oblique strokes corresponding respectively to the minimum ambient temperature of operation, the maximum temperature of operation and the number of days of exposure to damp heat (Steady state - test Ca) that they will withstand.

Category temperature range

The range of ambient temperatures for which the capacitor has been designed to operate continuously. This is defined by the temperature limits of the appropriate category.

Upper category temperature

The maximum ambient temperature for which a capacitor has been designed to operate continuously.

Lower category temperature

The minimum ambient temperature for which a capacitor has been designed to operate continuously.

Rated temperature

The maximum ambient temperature at which the rated voltage may be applied continuously.

Self-healing

The process by which the electrical properties of a metallized capacitor, after a local breakdown are rapidly and essentially restored to the values before the breakdown.

Temperature characteristic of capacitance

The term characterizing his property applies mainly to capacitors of which the variations of capacitance as a function of temperature, linear or non-linear, cannot be expressed with precision and certainty.

The temperature characteristic of capacitance is the maximum reversible variation of capacitance produced over a given temperature range within the category temperature range. It is expressed normally as a percentage of the capacitance related to a reference temperature of 20 °C.

Temperature coefficient and cycle drift of capacitance

The terms characterizing these two properties apply to capacitors of which the variations of capacitance as a function of temperature are linear or approximately linear and can be expressed with a certain precision.

Temperature coefficient of capacitance

The rate of change of capacitance with temperature measured over the specified range of temperature. It is normally expressed in parts per million per degree Celsius ($10^{-6}/^{\circ}\text{C}$).

Temperature cyclic drift of capacitance

The maximum irreversible variation of capacitance observed at room temperature during or after the completion of a number of specified temperature cycles. It is expressed normally as a percentage of the capacitance related to a reference temperature. This is normally 20 °C.

Test information

Robustness of terminations

Tensile strength of terminations (Ua)
(Load in wire axis direction)

Wire diameter	0.6 and 0.8 mm:	load 10 N, 10 sec
	1.0 mm	load 20 N, 20 sec

Bending (Ub)

Wire diameter	0.6 and 0.8 mm:	load 5 N, 4 x 90 °
	1.0 mm	load 10 N, 4 x 90 °

Torsion (Uc)
(For axial capacitors only)

Severity 1:	three rotations of 360 °
Severity 2:	two rotations of 180 °

Rapid change of temperature (Na)

The rapid change of temperature test is intended to determine the effect on capacitors of a change of temperature or a succession of changes of temperature and consists of 5 cycles of 30 minutes at lower category temperature and 30 minutes at higher category temperature.

Dry heat (Ba)

The object of this test is to determine the ability of the capacitors to be used or stored at high temperature. The standard test is 16 hours at upper category temperature.

Damp heat cyclic (Db)

The object of this test is to determine the suitability of capacitors for use and storage under conditions of high humidity when combined with cyclic temperature changes and in general, producing condensation on surfaces of the capacitor. One cycle consists of 24 hour exposure to 55 °C and 95 - 100% relative humidity.

Cold (Aa)

The object of this test is to determine the ability of the capacitors to be used or stored at low temperature. The standard test is 2 hours at lower category temperature.

Damp heat steady state (Ca)

The object of this test is to determine the suitability of capacitors for use and storage under conditions of high humidity. This test is primarily intended to permit the observations of the effects of high humidity at constant temperature over a prescribed period. The capacitors are exposed to a damp heat environment which is maintained at a temperature of 40 °C and a R.H. of 90 to 95% for the number of days specified by the third set of two digits of the climatic category.

Selection guide

SELECTION GUIDE

The products shown in this selection guide fall into two classifications: preferred types and maintenance types.



Preferred types are product types which can be confidently used for development purposes and existing applications. **Maintenance types** are existing ranges for which no update is expected and for which long term future supply cannot be guaranteed; they should not, therefore, be used for new development.

The preferred types classification covers the following categories:



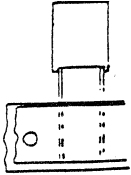

general purpose
interference suppression
AC and pulse
precision
specials

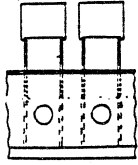
GENERAL PURPOSE

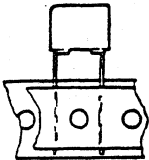

METALLIZED POLYESTER (MKT) POTTED

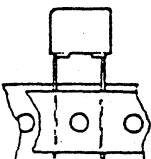
style 2222...	type	capacitance	rated voltage V	pitch mm	page
370	Radial (Straight)	0.056 - 1 μF 0.012 - 0.33 μF 0.0039 - 0.1 μF 0.001 - 0.033 μF	63 100 250 400	5.08 5.08 5.08 5.08	25
	 				
371	Radial (Straight)	0.56 - 1 μF 0.018 - 0.47 μF 0.0082 - 0.10 μF 0.0039 - 0.015 μF	63 100 250 400	7.62 7.62 7.62 7.62	25
	 				

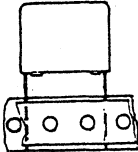
SELECTION GUIDE

style 2222...	type	capacitance	rated voltage V	pitch mm	page
372	Radial (Straight)	0.1 - 0.47 μF 0.047 - 0.15 μF 0.0047 - 0.047 μF	100 250 400	10 10 10	25
	 				
373	Radial (Straight)	0.47 - 4.7 μF 0.15 - 1.8 μF 0.047 - 0.68 μF	100 250 400	15; 22; 27 15; 22; 27 15; 22; 27	25
	   				

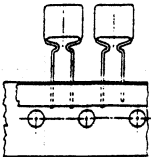
METALLIZED POLYESTER (MKT) LACQUERED

style 2222...	type	capacitance	rated voltage V	pitch mm	page
365	Radial (Crimped) 	0.047 - 1 μ F 0.01 - 0.47 μ F 0.018 - 0.047 μ F 0.0033 - 0.015 μ F	63 100 250 400	5.08 5.08 5.08 5.08	77
366	Radial (Crimped) 	0.047 - 1 μ F 0.01 - 0.47 μ F 0.018 - 0.047 μ F 0.0033 - 0.015 μ F	63 100 250 400	5.08; 7.62 5.08; 7.62 7.62 7.62	77
367	Radial (Straight) 	0.047 - 1 μ F 0.01 - 0.47 μ F 0.018 - 0.047 μ F 0.0033 - 0.015 μ F	63 100 250 400	5.08; 7.62 5.08; 7.62 7.62 7.62	77

SELECTION GUIDE

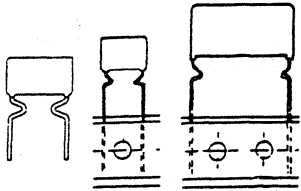
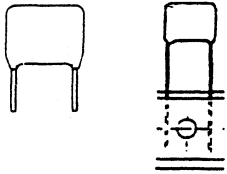
style 2222...	type	capacitance	rated voltage V	pitch mm	page
368	Radial (Crimped)	0.22 - 1 μF 0.056 - 6.8 μF 0.027 - 2.2 μF 0.001 - 1 μF 0.01 - 0.47 μF	63 100 250 400 630	10; 15; 22; 27 10; 15; 22; 27 10; 15; 22; 27 10; 15; 22; 27 10; 15; 22; 27	77
					
369	Radial (Straight)	0.22 - 1 μF 0.056 - 0.22 μF 0.027 - 0.10 μF 0.001 - 0.033 μF 0.01 - 0.022 μF	63 100 250 400 630	10.16 10.16 10.16 10.16 10.16	77
					

INTERFERENCE SUPPRESSION

METALLIZED POLYESTER - PAPER (MKT-P) POTTED

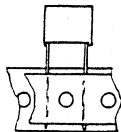
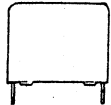
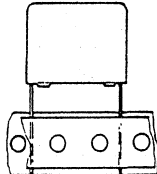
style 2222...	type	capacitance	rated voltage V	pitch mm	page
330 4....	Radial (straight)	0.01 - 0.1 μ F 0.15 - 1 μ F	250 250	15 22.5; 27.5	133
330 5....	Radial (straight)	0.01 - 0.047 μ F 0.068 - 0.68 μ F	250 250	15 22.5; 27.5	133
	 				
	 				

METALLIZED POLYESTER (MKT/MKT) POTTED

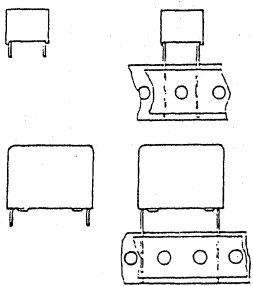
style 2222...	type	capacitance	rated voltage V	pitch mm	page
331	Radial (Straight)	0.01 - 0.068 μ F 0.1 - 0.47 μ F	250 250	15 22.5; 27.5	161
					

AC AND PULSE

POLYPROPYLENE FILM/FOIL (KP) POTTED

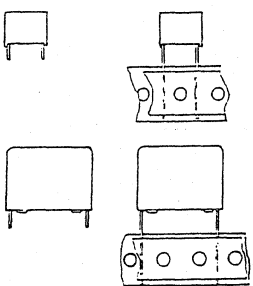
style 2222...	type	capacitance	rated voltage V	pitch mm	page
376	Radial (Straight)	0.0068 - 0.27 μ F 0.0047 - 0.18 μ F 0.0018 - 0.056 μ F 0.001 - 0.033 μ F	630 1000 1600 2000	15; 22; 27 15; 22; 27 15; 22; 27 15; 22; 27	189
					

METALLIZED POLYPROPYLENE (MKP) POTTED

style 2222...	type	capacitance	rated voltage V	pitch mm	page
378	Radial (Straight)	0.33 - 3.3 μ F 0.18 - 2 μ F 0.056 - 0.68 μ F 0.012 - 0.22 μ F 0.0056 - 0.1 μ F 0.0033 - 0.015 μ F	250 400 630 1000 1600 2000	22.5; 27.5 22.5; 27.5 22.5; 27.5 22.5; 27.5 22.5; 27.5 22.5; 27.5	223

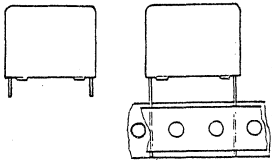

PRECISION

POLYSTYRENE FILM/FOIL (KS)

style 2222...	type	capacitance	rated voltage V	pitch mm	page
424/8 425/9 426/430 427/431	Axial sleeved	2000 - 39000 pF 1100 - 16000 pF 560 - 1100 pF 47 - 5600 pF	63 160 250 630		267

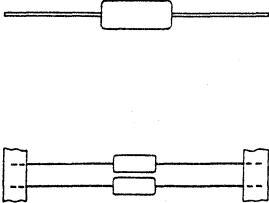

POLYPROPYLENE FILM/FOIL (KP) LACQUERED BODY

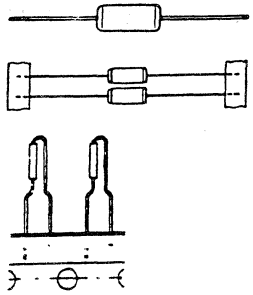
style 2222...	type	capacitance	rated voltage V	pitch mm	page
	Axial epoxy KP 460 461 462 463 464	6800 - 62000 pF 3600 - 39000 pF 1200 - 22000 pF 150 - 1100 pF 47 - 130 pF	63 160 250 400 630		301
					

SPECIALS

POLYESTER FILM/FOIL (KT) LACQUERED

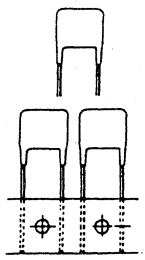
style 2222...	type	capacitance	rated voltage V	pitch mm	page
	Radial (Straight) 311 90015/16	5000 - 7000 pF	250		341
					

SELECTION GUIDE

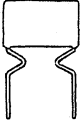
style 2222...	type	capacitance	rated voltage V	pitch mm	page
347	Radial (Crimped)	0.015 - 1 μ F 0.0082 - 0.68 μ F 0.0047 - 0.33 μ F 0.001 - 0.15 μ F	100 250 400 630	10; 15; 22; 27 10; 15; 22; 27 10; 15; 22; 27 10; 15; 22; 27	369
					

POLYESTER FILM/FOIL (KT) POTTED

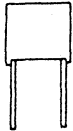
311 90026	Radial	3000 pF	250		357
311 90027	(Straight)	1200 pF	250		
					

METALLIZED POLYCARBONATE (MKC) POTTED

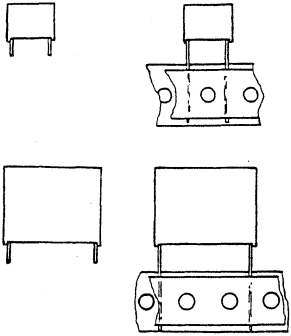
344	Radial (Straight)	0.082 - 6.8 μ F 0.039 - 2.2 μ F 0.01 - 1 μ F 0.01 - 0.47 μ F	100 250 400 630	10; 15; 22; 27 10; 15; 22; 27 10; 15; 22; 27 10; 15; 22; 27	397
					

MAINTENANCE

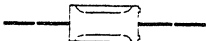
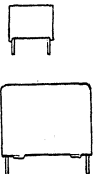
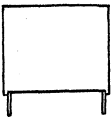
style 2222...	type	capacitance	rated voltage V	pitch mm	page
341	Axial moulded MKT 	0.082 - 6.8 μ F 0.039 - 2.2 μ F 0.0082 - 1 μ F	100 250 400		431
344	Radial potted MKT 	0.18 - 10 μ F 0.082 - 10 μ F 0.039 - 2.2 μ F 0.01 - 1 μ F	63 100 250 400	10; 15; 22; 27 10; 15; 22; 27 10; 15; 22; 27 10; 15; 22; 27	449
357-5	Radial potted KP 	0.22 - 0.82 μ F	250	27.5	467

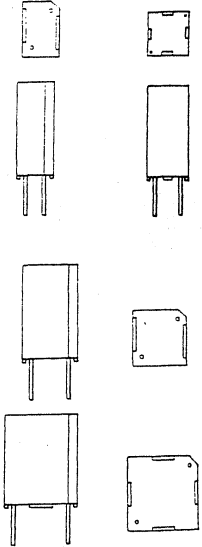
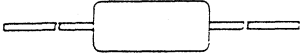
style 2222...	type	capacitance	rated voltage V	pitch mm	page
443	Radial potted KS	100 - 3920 pF 100 - 15000 pF 15400 - 34000 pF 100 - 7500 pF	63 63 63 63	5.08 7.62 10.16 5.08	481
					
444	Axial wrapped KS	43000 - 162000 pF 18000 - 82000 pF 12000 - 47000 pF 6200 - 24000 pF	63 160 250 630		507
					

SELECTION GUIDE

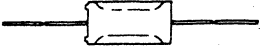
style 2222...	type	capacitance	rated voltage V	pitch mm	page
341	Axial moulded MKC	0.082 - 6.8 μF 0.039 - 2.2 μF 8200 - 1 μF 8200 - 0.47 μF 8200 - 0.15 μF 0.0082 - 0.068 μF	100 250 400 630 1000 1600		525
					

General purpose

Philips Components

Data sheet	
status	Product specification
date of issue	May 1990

2222 370/371/372/373

Metallized polyethyleneterephthalate film capacitors

MKT Radial potted types

- ° 5,08 to 27,5mm terminal pitch
- ° Supplied loose in box and on tape







QUICK REFERENCE DATA

Capacitance range (E12-series)	0,001 to 15 μ F
Capacitance tolerance	\pm 20%, \pm 10%, \pm 5%
Rated voltage U _{Rdc}	63V, 100V, 250V, 400V
Climatic category	55/100/56
Rated temperature	85°C
Tangent of loss angle at 10kHz	100 x 10 ⁻⁴
Related specification	IEC 384-2 DIN 44122, DIN 45910 Entwurf
Performance grade	Grade 1 (long life)
Qualified according to	CECC 30401-801

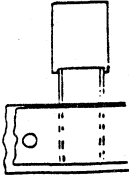
**Metallized polyethyleneterephthalate
film capacitors**

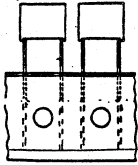
2222 370/371/372/373

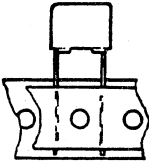
SURVEY OF STYLES

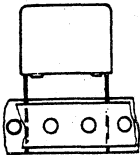
		<u>style</u>	<u>pitch</u>	<u>tables</u>
		2222 370	5,08mm	1 to 8
		2222 371	7,62mm	9 to 12
		2222 372 2222 373	10mm 15mm	13 to 15 16 to 18
		2222 373	22,5 to 27,5mm	16 to 18

CONSTRUCTION

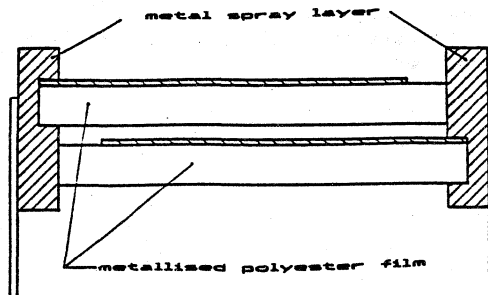

Metalized polyethyleneterephthalate film capacitors

2222 370/371/372/373

APPLICATION

In electronic circuits for blocking and coupling, bypass and energy reservoir applications. Their defined dimensions make them extremely suitable for circuits with high packaging density.

DESCRIPTION

The capacitors consist of a low-inductive wound cell of metalized polyethyleneterephthalate (PETP) film. The cell is potted with epoxy resin in a blue flame retardent case*. The radial leads are of solder-coated wire. The capacitors can withstand solvents and rinsing liquids without damage. They have small stand-off pips to allow removal of solder flux etc., during cleaning of the printed-wiring board.

- * polymethylpentene case (pitch 5,04mm and pitch 7,62 mm)
- polypropylene case (pitch > 7,62mm)

1. GENERAL DATA

1.1. Mounting

Normal use

The capacitors are designed for printed wiring applications.

The capacitors packed in bandoliers are designed for mounting on printed-wiring boards by means of automatic insertion machines.

Specific method of mounting to withstand vibration and shock

In order to withstand vibration and shock tests, it must be insured that the stand-off pips are in good contact with the printed-wiring board. For case sizes up to and including a mass of 6 g the capacitors shall be mechanically fixed by the leads.

With larger case sizes the capacitors shall be mounted in the same way and the body shall be clamped.

Metallized polyethyleneterephthalate film capacitors

2222 370/371/372/373

1.2.1 Dimensions in mm

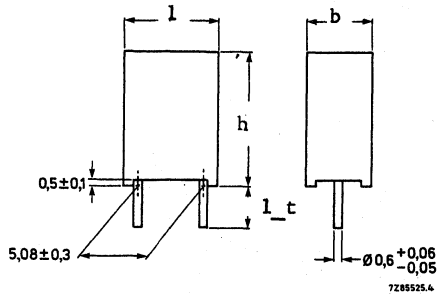

Fig. 1

Table 1 U_{Rdc} = 63V; max. a.c. voltage = 40V, Fig. 1

capacitance	b _{max}	h _{max}	l _{max}	mass	catalogue number 2222 370					
					loose in box Fig. 1					
					l _t = 4 + 1 -0,5			l _t = 26 + 1		
					C-tol + 20%	C-tol + 10%	C-tol + 5%	C-tol + 20%	C-tol + 10%	C-tol + 5%
*										
µF				g						
0,056					10563	11563	12563	14563	15563	16563
0,068					10683	11683	12683	14683	15683	16683
0,082	2,5	6,5	7,2	0,25	10823	11823	12823	14823	15823	16823
0,1					10104	11104	12104	14104	15104	16104
0,12					10124	11124	12124	14124	15124	16124
0,15					10154	11154	12154	14154	15154	16154
0,18	3,5	8	7,2	0,35	10184	11184	12184	14184	15184	16184
0,22					10224	11224	12224	14124	15224	16224
0,27					10274	11274	12274	14274	15274	16274
0,33					10334	11334	12334	14334	15334	16334
0,39	4,5	9	7,2	0,45	10394	11394	12394	14394	15394	16394
0,47					10474	11474	12474	14474	15474	16474
0,56	5	10	7,2	0,5	10564	11564	12564	14564	15564	16564
0,68					10684	11684	12684	14684	15684	16684
0,82	6	11	7,2	0,6	10824	11824	12824	14824	15824	16824
1					10105	11105	12105	14105	15105	16105

* Capacitance range according to CECC 30401-801

Metallized polyethyleneterephthalate film capacitors

2222 370/371/372/373

Table 2 U_{Rdc} = 63V; max. a.c. voltage = 40V, Fig. 1

capacitance * µF	b _{max}	h _{max}	l _{max}	mass g	catalogue number 2222 370													
					taped on reel Fig. 5						in tape height 16 +0,3 Fig. 5						in tape height 18 +2 Fig. 5	
					C-tol ± 20%	C-tol ± 10%	C-tol + 5%	C-tol + 20%	C-tol ± 10%	C-tol ± 5%	C-tol + 20%	C-tol ± 10%	C-tol ± 5%	C-tol + 20%	C-tol ± 10%	C-tol ± 5%		
0,056					17563	18563	19563	77563	78563	79563	74563	75563	76563					
0,068	2,5	6,5	7,2	0,25	17683	18683	19683	77683	78683	79683	74683	75683	76683					
0,082					17823	18823	19823	77823	78823	79823	74823	75823	76823					
0,1					17104	18104	19104	77104	78104	79104	74104	75104	76104					
0,12					17124	18124	19124	77124	78124	79124	74124	75124	76124					
0,15					17154	18154	19154	77154	78154	79154	74154	75154	76154					
0,18	3,5	8	7,2	0,35	17184	18184	19184	77184	78184	79184	74184	75184	76184					
0,22					17224	18224	19224	77224	78224	79224	74224	75224	76224					
0,27					17274	18274	19274	77274	78274	79274	74274	75274	76274					
0,33					17334	18334	19334	77334	78334	79334	74334	75334	76334					
0,39	4,5	9	7,2	0,45	17394	18394	19394	77394	78394	79394	74394	75394	76394					
0,47					17474	18474	19474	77474	78474	79474	74474	75474	76474					
0,56	5	10	7,2	0,5	17564	18564	19564	77564	78564	79564	74564	75564	76564					
0,68					17684	18684	19684	77684	78684	79684	74684	75684	76684					
0,82	6	11	7,2	0,6	17824	18824	19824	77824	78824	79824	74824	75824	76824					
1					17105	18105	19105	77105	78105	79105	74105	75105	76105					

*Capacitance range according to CECC 30401-801

**Metallized polyethyleneterephthalate
film capacitors**
2222 370/371/372/373
Table 3 $U_{Rdc} = 100V$; max. a.c. voltage = 63V, Fig. 1

capacitance	b_max	h_max	l_max	mass	catalogue number 2222 370					
					loose in box Fig. 1					
					l_t = 4 + 1 -0,5			l_t = 26 + 1		
					C-tol + 20%	C-tol + 10%	C-tol + 5%	C-tol + 20%	C-tol + 10%	C-tol + 5%
*				g						
μF										
0,012					20123	21123	22123	24123	25123	26123
0,015					20153	21153	22153	24153	25153	26153
0,018					20183	21183	22183	24183	25183	26183
0,022	2,5	6,5	7,2	0,25	20223	21223	22223	24223	25223	26223
0,027					20273	21273	22273	24273	25273	26273
0,033					20333	21333	22333	24333	25333	26333
0,039					20393	21393	22393	24393	25393	26393
0,047					20473	21473	22473	24473	25473	26473
0,056					20563	21563	22563	24563	25563	26563
0,068	3,5	8	7,2	0,35	20683	21683	22683	24683	25683	26683
0,082					20823	21823	22823	24823	25823	26823
0,10					20104	21104	22104	24104	25104	26104
0,12	4,5	9	7,2	0,45	20124	21124	22124	24124	25124	26124
0,15					20154	21154	22154	24154	25154	26154
0,18	5	10	7,2	0,50	20184	21184	22184	24184	25184	26184
0,22					20224	21224	22224	24224	25224	26224
0,27	6	11	7,2	0,60	20274	21274	22274	24274	25274	26274
0,33					20334	21334	22334	24334	25334	26334

*Capacitance range according to CECC 30401-801

Metallized polyethyleneterephthalate film capacitors

2222 370/371/372/373

Table 4 U_{Rdc} = 100V; max. a.c. voltage = 63V, Fig. 1

capacitance		b_max	h_max	l_max	mass	catalogue number 2222 370											
						on tape on reel Fig. 5				in tape height 16 +0,3 Fig. 5				on tape in ammunition pack in tape height 18 +2 Fig. 5			
*	µF	C-tol + 20%	C-tol + 10%	C-tol + 5%	g	C-tol + 20%	C-tol + 10%	C-tol + 5%	C-tol + 20%	C-tol + 10%	C-tol + 5%	C-tol + 20%	C-tol + 10%	C-tol + 5%			
0,012		27123	28123	29123		87123	88123	89123	84123	85123	86123	84123	85123	86123			
0,015		27153	28153	29153		87153	88153	89153	84153	85153	86153	84153	85153	86153			
0,018		27183	28183	29183		87183	88183	89183	84183	85183	86183	84183	85183	86183			
0,022	2,5	27223	28223	29223	0,25	87223	88223	89223	84223	85223	86223	84223	85223	86223			
0,027		27273	28273	29273		87273	88273	89273	84273	85273	86273	84273	85273	86273			
0,033		27333	28333	29333		87333	88333	89333	84333	85333	86333	84333	85333	86333			
0,039		27393	28393	29393		87393	88393	89393	84393	85393	86393	84393	85393	86393			
0,047		27473	28473	29473		87473	88473	89473	84473	85473	86473	84473	85473	86473			
0,056		27563	28563	29563		87563	88563	89563	84563	85563	86563	84563	85563	86563			
0,068		27683	28683	29683	0,35	87683	88683	89683	84683	85683	86683	84683	85683	86683			
0,082	3,5	27823	28823	29823		87823	88823	89823	84823	85823	86823	84823	85823	86823			
0,10		27104	28104	29104		87104	88104	89104	84104	85104	86104	84104	85104	86104			
0,12	4,5	27124	28124	29124	0,45	87124	88124	89124	84124	85124	86124	84124	85124	86124			
0,15		27154	28154	29154		87154	88154	89154	84154	85154	86154	84154	85154	86154			
0,18	5	27184	28184	29184	0,50	87184	88184	89184	84184	85184	86184	84184	85184	86184			
0,22		27224	28224	29224		87224	88224	89224	84224	85224	86224	84224	85224	86224			
0,27	6	27274	28274	29274	0,60	87274	88274	89274	84274	85274	86274	84274	85274	86274			
0,33		27334	28334	29334		87334	88334	89334	84334	85334	86334	84334	85334	86334			

* Capacitance range according to GECC 30401-801

**Metallized polyethyleneterephthalate
film capacitors**
2222 370/371/372/373
Table 5 $U_{Rdc} = 250V$; max. a.c. voltage = 160V, Fig. 1

capacitance * μF	b_max	h_max	l_max	mass g	catalogue number 2222 370					
					loose in box Fig. 1					
					$l_t = 4 + 1$ -0,5			$l_t = 26 + 1$		
				C-tol $\pm 20\%$	C-tol $\pm 10\%$	C-tol $\pm 5\%$	C-tol $\pm 20\%$	C-tol $\pm 10\%$	C-tol $\pm 5\%$	
0,0039					40392	41392	42392	44392	45392	46392
0,0047					40472	41472	42472	44472	45472	46472
0,0056					40562	41562	42562	44562	45562	46562
0,0068					40682	41682	42682	44682	45682	46682
0,0082	2,5	6,5	7,2	0,25	40822	41822	42822	44822	45822	46822
0,01					40103	41103	42103	44103	45103	46103
0,012					40123	41123	42123	44123	45123	46123
0,015					40153	41153	42153	44153	45153	46153
0,018					40183	41183	42183	44183	45183	46183
0,022	3,5	8	7,2	0,35	40223	41223	42223	44223	45223	46223
0,027					40273	41273	42273	44273	45273	46273
0,033					40333	41333	42333	44333	45333	46333
0,039	4,5	9	7,2	0,45	40393	41393	42393	44393	45393	46393
0,047					40473	41473	42473	44473	45473	46473
0,056					40563	41563	42563	44563	45563	46563
0,068					40683	41683	42683	44683	45683	46683
0,082	6	11	7,2	0,60	40823	41823	42823	44823	45823	46823
0,1					40104	41104	42104	44104	45104	46104

* Capacitance range according to CECC 30401-801

** Capacitance range 0,0039 to 0,01 μF CECC pending

**Metallized polyethyleneterephthalate
film capacitors**

2222 370/371/372/373

Table 6 U_{Rdc} = 250V; max. a.c. voltage = 160V

capaci- tance	b _{max}	h _{max}	l _{max}	mass	catalogue number 2222 370								
					Taped on reel			ammopack					
					Fig. 5			in tape 16 +0,3 height -0,5		Fig. 5		in tape 18 +2 height 0	
* µF	g	C-tol	C-tol	C-tol	C-tol	C-tol	C-tol	C-tol	C-tol	C-tol	C-tol		
		+ 20%	+ 10%	+ 5%	+ 20%	+ 10%	+ 5%	+ 20%	+ 10%	+ 5%	+ 20%	+ 10%	+ 5%
0,0039					47392	48392	49392	37392	38392	39392	34392	35392	36392
0,0047					47472	48472	49472	37472	38472	39472	34472	35472	36472
0,0056					47562	48562	49562	37562	38562	39562	34562	35562	36562
0,0068					47682	48682	49682	37682	38682	39682	34682	35682	36682
0,0082	2,5	6,5	7,2	0,25	47822	48822	49822	37822	38822	39822	34822	35822	36822
0,01					47103	48103	49103	37103	38103	39103	34103	35103	36103
0,012					47123	48123	49123	37123	38123	39123	34123	35123	36123
0,015					47153	48153	49153	37153	38153	39153	34153	35153	36153
0,018					47183	48183	49183	37183	38183	39183	34183	35183	36183
0,022	3,5	8	7,2	0,35	47223	48223	49223	37223	38223	39223	34223	35223	36223
0,027					47273	48273	49273	37273	38273	39273	34273	35273	36273
0,033					47333	48333	49333	37333	38333	39333	34333	35333	36333
0,039					47393	48393	49393	37393	38393	39393	34393	35393	36393
0,047	4,5	9	7,2	0,45	47473	48473	49473	37473	38473	39473	34473	35473	36473
0,056					47563	48563	49563	37563	38563	39563	34563	35563	36563
0,068	6	11	7,2	0,6	47683	48683	49683	37683	38683	39683	34683	35683	36683
0,082					47823	48823	49823	37823	38823	39823	34823	35823	36823
0,1					47104	48104	49104	37104	38104	39104	34104	35104	36104

* Capacitance range according to CECC 30401-801

** Capacitance range 0,0039 to 0,01 µF CECC pending

Metallized polyethyleneterephthalate film capacitors

2222 370/371/372/373

Table 7 $U_{Rdc} = 400V$; max. a.c. voltage = 220V, Fig. 1

capacitance * μF	b_max	h_max	l_max	mass g	catalogue number 2222 370 loose in box Fig. 1					
					$l_t = 4 + 1$ -0,5			$l_t = 26 + 1$		
					C-tol + 20%	C-tol + 10%	C-tol + 5%	C-tol + 20%	C-tol + 10%	C-tol + 5%
0,001					50102	51102	52102	54102	55102	56102
0,0012					50122	51122	52122	54122	55122	56122
0,0015					50152	51152	52152	54152	55152	56152
0,0018					50182	51182	52182	54182	55182	56182
0,0022	2,5	6,5	7,2	0,25	50222	51222	52222	54222	55222	56222
0,0027					50272	51272	52272	54272	55272	56272
0,0033					50332	51332	52332	54332	55332	56332
0,0039					50392	51392	52392	54392	55392	56392
0,0047					50472	51472	52472	54472	55472	56472
0,0056					50562	51562	52562	54562	55562	56562
0,0068	3,5	8	7,2	0,35	50682	51682	52682	54682	55682	56682
0,0082					50822	51822	52822	54822	55822	56822
0,01					50103	51103	52103	54103	55103	56103
0,012	4,5	9	7,2	0,45	50123	51123	52123	54123	55123	56123
0,015					50153	51153	52153	54153	55153	56153
0,018	5	10	7,2	0,50	50183	51183	52183	54183	55183	56183
0,022					50223	51223	52223	54223	55223	56223
0,027	6	11	7,2	0,60	50273	51273	52273	54273	55273	56273
0,033					50333	51333	52333	54333	55333	56333

* Capacitance range according to CECC 30401-801

** Capacitance range 0,001 to 0,0033 μF CECC pending

**Metallized polyethyleneterephthalate
film capacitors**
2222 370/371/372/373
Table 8 $U_{Rdc} = 400V$; max. a.c. voltage = 220V

capacitance	b_max	h_max	l_max	mass	catalogue number 2222 370								
					taped on reel			ammopack					
					Fig. 5			in tape 16 +0,3 height -0,5		in tape 18 +2 height 0			
					Fig. 5			Fig. 5		Fig. 5			
* μF				g	C-tol + 20%	C-tol + 10%	C-tol + 5%	C-tol + 20%	C-tol + 10%	C-tol + 5%	C-tol + 20%	C-tol + 10%	C-tol + 5%
0,001					57102	58102	59102	67102	68102	69102	64102	65102	66102
0,0012					57122	58122	59122	67122	68122	69122	64122	65122	66122
0,0015					57152	58152	59152	67152	68152	69152	64152	65152	66152
0,0018					57182	58182	59182	67182	68182	69182	64182	65182	66182
0,0022	2,5	6,5	7,2	0,25	57222	58222	59222	67222	68222	69222	64222	65222	66222
0,0027					57272	58272	59272	67272	68272	69272	64272	65272	66272
0,0033					57332	58332	59332	67332	68332	69332	64332	65332	66332
0,0039					57392	58392	59392	67392	68392	69392	64392	65392	66392
0,0047					57472	58472	59472	67472	68472	69472	64472	65472	66472
0,0056	3,5	8	7,2	0,35	57562	58562	59562	67562	68562	69562	64562	65562	66562
0,0068					57682	58682	59682	67682	68682	69682	64682	65682	66682
0,0082					57822	58822	59822	67822	68822	69822	64822	65822	66822
0,01					57103	58103	59103	67103	68103	69103	64103	65103	66103
0,012	4,5	9	7,2	0,45	57123	58123	59123	67123	68123	69123	64123	65123	66123
0,015					57153	58153	59153	67153	68153	69153	64153	65153	66153
0,018	5	10	7,2	0,50	57183	58183	59183	67183	68183	69183	64183	65183	66183
0,022					57223	58223	59223	67223	68223	69223	64223	65223	66223
0,027	6	11	7,2	0,60	57273	58273	59273	67273	68273	69273	64273	65273	66273
0,033					57333	58333	59333	67333	68333	69333	64333	65333	66333

* Capacitance range according to CECC 30401-801

** Capacitance range 0,001 to 0,0033 μF CECC pending

Metallized polyethyleneterephthalate film capacitors

2222 370/371/372/373

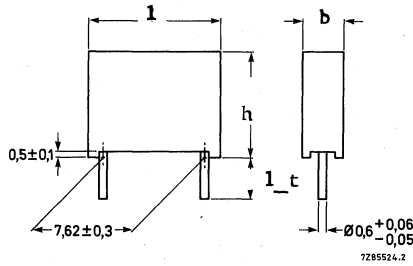

Fig. 2

Table 9 U_{Rdc} = 63V; max. a.c. voltage = 40V, Fig. 2

capacitance		b_max h_max l_max mass		catalogue number 2222 371																					
*		loose in box			l _t = 4 + l			Fig. 2			height 16,5 ± 0,3			taped on reel			Fig. 6								
μF		-0,5			± 20% ± 10% ± 5%			± 20% ± 10% ± 5%			± 20% ± 10% ± 5%			± 20% ± 10% ± 5%			± 20% ± 10% ± 5%								
		C-tol	C-tol	C-tol	C-tol	C-tol	C-tol	C-tol	C-tol	C-tol	C-tol	C-tol	C-tol	C-tol	C-tol	C-tol	C-tol	C-tol	C-tol						
0,056	0,068	10563	11563	12563	14563	15563	16563	17563	18563	19563	34563	35563	36563	10154	11154	12154	14154	15154	16154	17154	18154	19154	34154	35154	36154
0,082	0,1	10683	11683	12683	14683	15683	16683	17683	18683	19683	34683	35683	36683	10154	11154	12154	14154	15154	16154	17154	18154	19154	34154	35154	36154
0,12	0,15	10823	11823	12823	14823	15823	16823	17823	18823	19823	34823	35823	36823	10104	11104	12104	14104	15104	16104	17104	18104	19104	34104	35104	36104
0,18	0,22	10124	11124	12124	14124	15124	16124	17124	18124	19124	34124	35124	36124	10224	11224	12224	14224	15224	16224	17224	18224	19224	34224	35224	36224
0,27	0,33	10274	11274	12274	14274	15274	16274	17274	18274	19274	34274	35274	36274	10334	11334	12334	14334	15334	16334	17334	18334	19334	34334	35334	36334
0,39	0,47	10394	11394	12394	14394	15394	16394	17394	18394	19394	34394	35394	36394	10474	11474	12474	14474	15474	16474	17474	18474	19474	34474	35474	36474
0,56	0,68	10564	11564	12564	14564	15564	16564	17564	18564	19564	34564	35564	36564	10684	11684	12684	14684	15684	16684	17684	18684	19684	34684	35684	36684
0,82	1	10824	11824	12824	14824	15824	16824	17824	18824	19824	34824	35824	36824	10105	11105	12105	14105	15105	16105	17105	18105	19105	34105	35105	36105

*Capacitance range according to CECC 30401-801

Metallized polyethyleneterephthalate film capacitors

2222 370/371/372/373

Table 10 U_{Rdc} = 100V; max. a.c. voltage = 63V, Fig. 2

catalogue number 2222 371																
capacitance	b _{max}	h _{max}	l _{max}	mass	loose in box Fig. 2		taped on reel Fig. 6		height 16,5 ± 0,3		height 18 ± 2					
					l _t = 4 + 1 - 0,5	l _t = 26 + 1	C-tol + 20%	C-tol + 5%	C-tol + 20%	C-tol + 5%	C-tol + 20%	C-tol + 5%	C-tol + 20%	C-tol + 5%		
*																
μF				g												
0,018					20183	21183	22183	24183	25183	26183	27183	28183	29183	64183	65183	66183
0,022					20223	21223	22223	24223	25223	26223	27223	28223	29223	64223	65223	66223
0,027					20273	21273	22273	24273	25273	26273	27273	28273	29273	64273	65273	66273
0,033	2,5	6,5	10	0,3	20333	21333	22333	24333	25333	26333	27333	28333	29333	64333	65333	66333
0,039					20393	21393	22393	24393	25393	26393	27393	28393	29393	64393	65393	66393
0,047					20473	21473	22473	24473	25473	26473	27473	28473	29473	64473	65473	66473
0,056					20563	21563	22563	24563	25563	26563	27563	28563	29563	64563	65563	66563
0,068	3	8	10	0,4	20683	21683	22683	24683	25683	26683	27683	28683	29683	64683	65683	66683
0,082					20823	21823	22823	24823	25823	26823	27823	28823	29823	64823	65823	66823
0,10					20104	21104	22104	24104	25104	26104	27104	28104	29104	64104	65104	66104
0,12					20124	21124	22124	24124	25124	26124	27124	28124	29124	64124	65124	66124
0,15	4	9	10	0,5	20154	21154	22154	24154	25154	26154	27154	28154	29154	64154	65154	66154
0,18					20184	21184	22184	24184	25184	26184	27184	28184	29184	64184	65184	66184
0,22					20224	21224	22224	24224	25224	26224	27224	28224	29224	64224	65224	66224
0,27					20274	21274	22274	24274	25274	26274	27274	28274	29274	64274	65274	66274
0,33	5	10,5	10	0,65	20334	21334	22334	24334	25334	26334	27334	28334	29334	64334	65334	66334
0,39					20394	21394	22394	24394	25394	26394	27394	28394	29394	64394	65394	66394
0,47					20474	21474	22474	24474	25474	26474	27474	28474	29474	64474	65474	66474

*Capacitance range according to CECC 30401-801

**Metallized polyethyleneterephthalate
film capacitors**

2222 370/371/372/373

Table 11 U_{Rdc} = 250V; max. a.c. voltage = 160V, Fig. 2

catalogue number 2222 371											
capacitance	b _{max}	h _{max}	l _{max}	mass	loose in box Fig. 2		taped on reel		Fig. 6		
					l _t = 4 + 1 -0,5	l _t = 26 + 1	height 16,5 +0,3		height 18 + 2		
*											
μF				g	C-tol + 20% - 5%	C-tol + 10% - 5%	C-tol + 20% - 5%	C-tol + 10% - 5%	C-tol + 20% - 5%	C-tol + 10% - 5%	C-tol + 20% - 5%
0,0082					40822 41822 42822 44822 45822 46822 47822 48822 49822 74822 75822 76822						
0,010					40103 41103 42103 44103 45103 46103 47103 48103 49103 74103 75103 76103						
0,012	2,5	6,5	10	0,3	40123 41123 42123 44123 45123 46123 47123 48123 49123 74123 75123 76123						
0,015					40153 41153 42153 44153 45153 46153 47153 48153 49153 74153 75153 76153						
0,018					40183 41183 42183 44183 45183 46183 47183 48183 49183 74183 75183 76183						
0,022					40223 41223 42223 44223 45223 46223 47223 48223 49223 74223 75223 76223						
0,027	3	8	10	0,4	40273 41273 42273 44273 45273 46273 47273 48273 49273 74273 75273 76273						
0,033					40333 41333 42333 44333 45333 46333 47333 48333 49333 74333 75333 76333						
0,039					40393 41393 42393 44393 45393 46393 47393 48393 49393 74393 75393 76393						
0,047					40473 41473 42473 44473 45473 46473 47473 48473 49473 74473 75473 76473						
0,056	4	9	10	0,5	40563 41563 42563 44563 45563 46563 47563 48563 49563 74563 75563 76563						
0,068					40683 41683 42683 44683 45683 46683 47683 48683 49683 74683 75683 76683						
0,082	5	10,5	10	0,65	40823 41823 42823 44823 45823 46823 47823 48823 49823 74823 75823 76823						
0,10					40104 41104 42104 44104 45104 46104 47104 48104 49104 74104 75104 76104						

*Capacitance range according to CECC 30401-801

Metallized polyethyleneterephthalate film capacitors

2222 370/371/372/373

Table 12 U_{Rdc} = 400V; max. a.c. voltage = 220V, Fig. 2

capacitance		b _{max}	h _{max}	l _{max}	l _{mass}	catalogue number 2222 371											
						loose in box Fig. 2			taped on reel Fig. 6								
		l _t = 4 + 1			l _t = 26 + 1			height 16,5 +0,3			height 18 + 2						
		-0,5															
		C-tol	C-tol	C-tol	C-tol	C-tol	C-tol	C-tol	C-tol	C-tol	C-tol	C-tol	C-tol				
		+ 20%	+ 10%	+ 5%	+ 20%	+ 10%	+ 5%	+ 20%	+ 10%	+ 5%	+ 20%	+ 10%	+ 5%				
*																	
μF				g													
0,0039					50392	51392	52392	54392	55392	56392	57392	58392	59392				
0,0047					50472	51472	52472	54472	55472	56472	57472	58472	59472				
0,0056	2,5	6,5	10	0,3	50562	51562	52562	54562	55562	56562	57562	58562	59562				
0,0068					50682	51682	52682	54682	55682	56682	57682	58682	59682				
0,0082	3	8	10	0,4	50822	51822	52822	54822	55822	56822	57822	58822	59822				
0,01					50103	51103	52103	54103	55103	56103	57103	58103	59103				
0,012	4	9	10	0,5	50123	51123	52123	54123	55123	56123	57123	58123	59123				
0,015					50153	51153	52153	54153	55153	56153	57153	58153	59153				

*Capacitance range according to CECC 30401-801

**Metallized polyethyleneterephthalate
film capacitors**

2222 370/371/372/373

Dimensions in mm

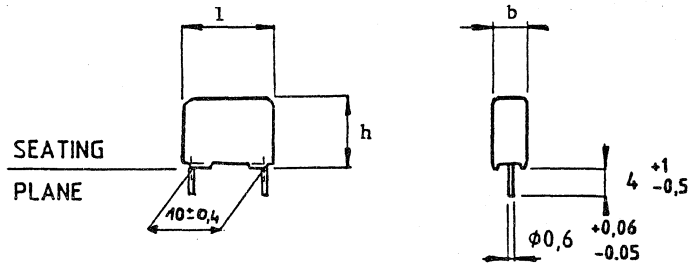

Table 13 $U_{Rdc} = 100V$; max. a.c. voltage = 63V, Fig. 3

ca- paci- tance	b _{max}	h _{max}	l _{max}	mass	catalogue number 2222 372			
					Loose in box Fig. 3		Taped on reel Fig. 7	
					C-tol	C-tol	C-tol	C-tol
					+10%	+5%	+10%	+5%
* μF				g				
0,1	4	9	12,5		21104	22104	25104	26104
0,12	4	9	12,5		21124	22124	25124	26124
0,15	4	9	12,5	0,55	21154	22154	25154	26154
0,18	4	9	12,5		21184	22184	25184	26184
0,22	4	9	12,5		21224	22224	25224	26224
0,27	4	10	12,5	0,60	21274	22274	25274	26274
0,33	4	10	12,5		21334	22334	25334	26334
0,39	5	11	12,5	0,85	21394	22394	25394	26394
0,47	5	11	12,5		21474	22474	25474	26474

* Capacitance range according to CECC 30401-801

**Metallized polyethyleneterephthalate
film capacitors**
2222 370/371/372/373
Table 14 $U_{Rdc} = 250V$; max. a.c. voltage = 160V, Fig. 3

ca- paci- tance	b_max	h_max	l_max	mass	catalogue number 2222 372			
					Loose in box Fig. 3		Taped on reel Fig. 7	
					C-tol +10%	C-tol +5%	C-tol +10%	C-tol +5%
*				g				
μF								
0,047	4	9	12,5		41473	42473	45473	46473
0,056	4	9	12,5	0,55	41563	42463	45463	46463
0,068	4	9	12,5		41683	42683	45683	46683
0,082	4	10	12,5	0,60	41823	42823	45823	46823
0,10	4	10	12,5		41104	42104	45104	46104
0,12	5	11	12,5	0,85	41124	42124	45124	46124
0,15	5	11	12,5		41154	42514	45154	46154

* Capacitance range according to CECC 30401-801

**Metallized polyethyleneterephthalate
film capacitors**
2222 370/371/372/373
Table 15 $U_{Rdc} = 400V$; max. a.c. voltage = 220V, Fig. 3

ca- paci- tance	b_max	h_max	l_max	mass	catalogue number 2222 372			
					Loose in box Fig. 3		Taped on reel Fig. 7	
					C-tol	C-tol	C-tol	C-tol
					+10%	+5%	+10%	+5%
*								
μF				g				
0,0047	4	9	12,5		51472	52472	55472	56472
0,0056	4	9	12,5		51562	52562	55562	56562
0,0068	4	9	12,5		51682	52682	55682	56682
0,0082	4	9	12,5		51822	52822	55822	56822
0,010	4	9	12,5	0,55	51103	52103	55103	56103
0,012	4	9	12,5		51123	52123	55123	56123
0,015	4	9	12,5		51153	52153	55153	56153
0,018	4	9	12,5		51183	52183	55183	56183
0,022	4	9	12,5		51223	52223	55223	56223
0,027	4	10	12,5	0,60	51273	52273	55273	56273
0,033	4	10	12,5		51333	52333	55333	56333
0,039	5	11	12,5	0,85	51393	52393	55393	56393
0,047	5	11	12,5		51473	52473	55473	56473

* Capacitance range according to CECC 30401-801

Metallized polyethyleneterephthalate film capacitors

2222 370/371/372/373

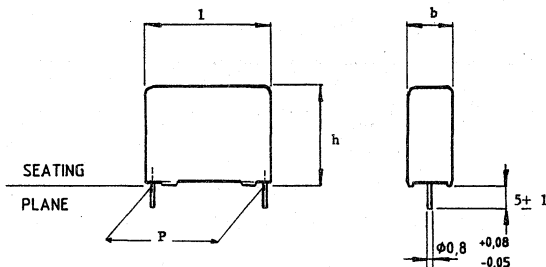

Fig. 4

Table 16 $U_{Rdc} = 100V$; max. a.c. voltage = 63V, Fig. 4

capacitance * μF	b_{max}	h_{max}	l_{max}	P	mass g	catalogue number 2222 373			
						Loose in box Fig. 4		Taped on reel Fig. 7 and 8	
						C-tol	C-tol	C-tol	C-tol
						+10%	+5%	+10%	+5%
0,47	5	11	17,5			21474	22474	25474	26474
0,56	5	11	17,5		1,05	21564	22564	25564	26564
0,68	5	11	17,5			21684	22684	25684	26684
0,82	6	12	17,5	15	1,4	21824	22824	25824	26824
1	6	12	17,5	+0,4		21105	22105	25105	26105
1,2	7	13,5	17,5		1,85	21125	22125	25125	26125
1,5	7	13,5	17,5			21155	22155	25155	26155
1,8	8,5	15	17,5		2,6	21185	22185	25185	26185
2,2	8,5	15	17,5			21225 **	22225 **	25225 **	26225 *
2,2	7	16,5	26		3,15	90002	90003	90008	90009
2,7	8,5	18	26	22,5	4,4	21275	22275	25275	26275
3,3	8,5	18	26	+0,4		21335	22335	25335	26335
3,9	10	19,5	26		5,5	21395	22395	25395	26395
4,7	10	19,5	26			21475 **	22475 **	25475 **	26475 *
5,6	11	21	31		7,8	21565	22565	25565	26565
6,8	11	21	31	27,5		21685	22685	25685	26685
8,2	13	23	31	+0,4	10,4	21825	22825	25825	26825
10	13	23	31			21106	22106	25106	26106
12	18	28	31		17,2	21126	22126	25126	26126
15	18	28	31			21156	22156	25156	26156
Capacitors available on special request									
0,33	5	11	17,5	15	1,05	21334	22334	25334	26334
0,39	5	11	17,5	+0,4		21394	22394	25394	26394
1,5	6	15,5	26	22,5	2,5	90012	90013	90018	90019
1,8	7	16,5	26	+0,4	3,15	90022	90023	90028	90029
4,7	9	19	31	27,5	5,75	90032	90033	90038	90039
				+0,4					

* Capacitance range according to CECC 30401-801
** CECC pending

Metallized polyethyleneterephthalate film capacitors

2222 370/371/372/373

Table 17 U_{Rdc} = 250V; max. a.c. voltage = 160V, Fig. 4

capacitance	b _{max}	h _{max}	l _{max}	P	mass	catalogue number 2222 373			
						Loose in box Fig. 4		Taped on reel Fig. 7 and 8	
						C-tol	C-tol	C-tol	C-tol
						+10%	+5%	+10%	+5%
*									
μF					g				
0,15	5	11	17,5			41154	42154	45154	46154
0,18	5	11	17,5		1,05	41184	42184	45184	46184
0,22	5	11	17,5			41224	42224	45224	46224
0,27	6	12	17,5	15		41274	42274	45274	46274
0,33	6	12	17,5	+0,4		41334	42334	45334	46334
0,39	6	12	17,5		1,4	41394	42394	45394	46394
0,47	6	12	17,5			41474 **	42474 **	45474 **	46474 **
0,56	7	13,5	17,5		1,85	41564 **	42564 **	45564 **	46564 **
0,68	7	13,5	17,5			41684 **	42684 **	45684 **	46684 **
0,82	8,5	15	17,5		2,6	41824 **	42824 **	45824 **	46824 **
1	8,5	15	17,5			41105 **	42105 **	45105 **	46105 **
1	7	14,5	26		3,15	90082	90083	90088	90089
1,2	8,5	18	26	22,5	4,4	41125	42125	45125	46125
1,5	8,5	18	26	+0,4		41155 **	42155 **	45155 **	46155 **
1,8	10	19,5	26		5,5	41185 **	42185 **	45185 **	46185 **
2,2	10	19,5	26			41225 **	42225 **	45225 **	46225 **
2,2	11	21	31		7,8	90112	90113	90118	90119
2,7	13	23	31		10,4	41275	42275	45275	46275
3,3	13	23	31			41335	42335	45335	46335
3,9	15	25	31	27,5	12,8	41395	42395	45395	46395
4,7	15	25	31	+0,4		41475	42475	45475	46475
Capacitors available on special request									
0,47	6	15,5	26			90042	90043	90048	90049
0,56	6	15,5	26	22,5	2,5	90052	90053	90058	90059
0,68	6	15,5	26	+0,4		90062	90063	90068	90069
0,82	7	16,5	26		3,15	90072	90073	90078	90079
1,2	9	19	31		5,75	90172	90173	90174	90175
1,5	9	19	31	27,5	5,75	90092	90093	90098	90099
1,8	11	21	31	+0,4	7,8	90102	90103	90108	90109

* Capacitance range according to CECC 30401-801

** CECC pending

Metallized polyethyleneterephthalate film capacitors

2222 370/371/372/373

Table 18 $U_{Rdc} = 400V$; max. a.c. voltage = 220V, Fig. 4

ca- paci- tance	b_max	h_max	l_max	P	mass	catalogue number 2222 373				
						Loose in box Fig. 4		Taped on reel Fig. 7 and 8		
						C-tol	C-tol	C-tol	C-tol	
						<u>+10%</u>	<u>+5%</u>	<u>+10%</u>	<u>+5%</u>	
* μF					g					
0,047	5	11	17,5			51473	52473	55473	56473	
0,056	5	11	17,5			51563	52563	55563	56563	
0,068	5	11	17,5		1,05	51683	52683	55683	56683	
0,08	5	11	17,5	15		51823	52823	55823	56823	
0,1	5	11	17,5	+0,4		51104	52104	55104	56104	
0,12	6	12	17,5		1,4	51124	52124	55124	56124	
0,15	6	12	17,5			51154	52154	55154	56154	
0,18	7	13,5	17,5		1,85	51184	52184	55184	56184	
0,22	7	13,5	17,5			51224 **	52224 **	55224 **	56224 **	
0,27	8,5	15	17,5		2,6	51274 **	52274 **	55274 **	56274 **	
0,33	8,5	15	17,5			51334 **	52334 **	55334 **	56334 **	
0,39	8,5	18	26		4,4	51394	52394	55394	56394	
0,47	8,5	18	26	22,5		51474	52474	55474	56474	
0,56	10	19,5	26	+0,4		51565	52564	55564	56564	
0,68	10	19,5	26		5,5	51684	52684	55684	56684	
0,82	11	21	31		7,8	51824	52824	55824	56824	
1	11	21	31	27,5		51105	52105	55105	56105	
1,2	15	25	31	+0,4	12,8	51125	52125	55125	56125	
1,5	15	25	31			51155	52155	55155	56155	
Capacitors available on special request										
0,22	6	15,5	26		2,5	90122	90123	90128	90129	
0,27	7	16,5	26	22,5	3,15	90132	90133	90138	90139	
0,33	7	16,5	26	+0,4		90142	90143	90148	90149	
0,68	9	19	31	27,5	5,75	90152	90153	90158	90159	
				+0,4						

* Capacitance range according to CECC 30401-801

** CECC pending

Metallized polyethyleneterephthalate film capacitors

2222 370/371/372/373

1.2.2 Packing

The capacitors are supplied loose in box, taped on reel or in ammpack, details of quantities are given in Tables 19 to 22.

Loose in box

Table 19 : Number of capacitors per box.

l_max mm	Number of capacitors per box			
	Short leads		Long leads	
7,2	2000	8000	1000	4000
10	1000	4000		
12,5	1000	4000		
17,5	1000	4000		
26	200	1000		
31	100	500		

Metallized polyethyleneterephthalate film capacitors

2222 370/371/372/373

Reel and ammunition packing

1. Dimensions of taped products

Style 2222 370

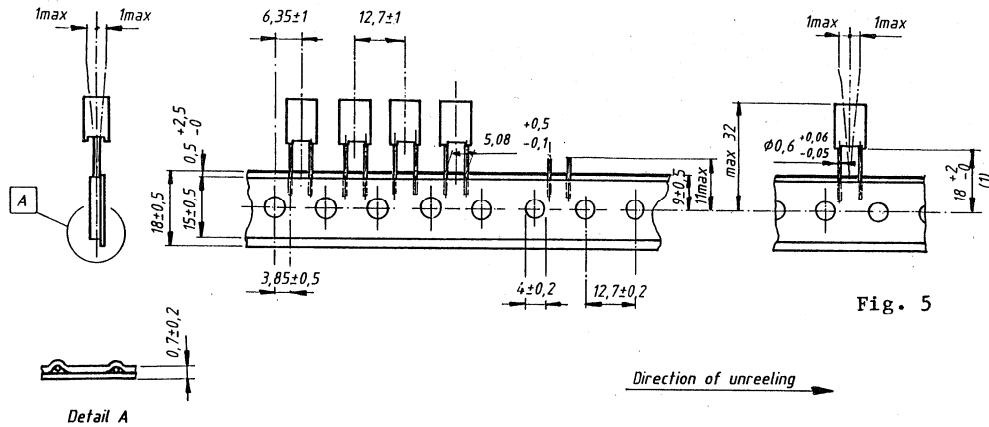

Fig. 5

(1) 16 or 18 for ammunition packing

Style 2222 371

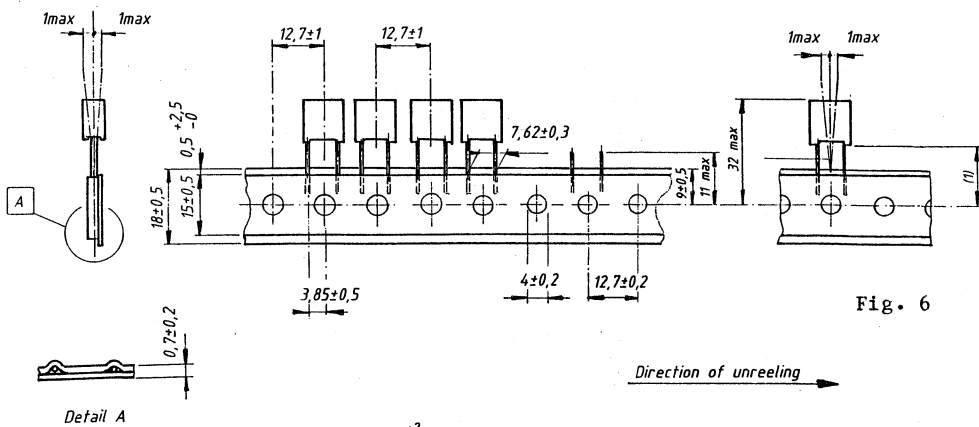

Fig. 6

(1) $16,5$ or 18 for ammunition packing

Metallized polyethyleneterephthalate film capacitors

2222 370/371/372/373

Style 2222 372, 2222 373

Capacitors with terminal pitch P = 10 or 15mm, Fig. 7

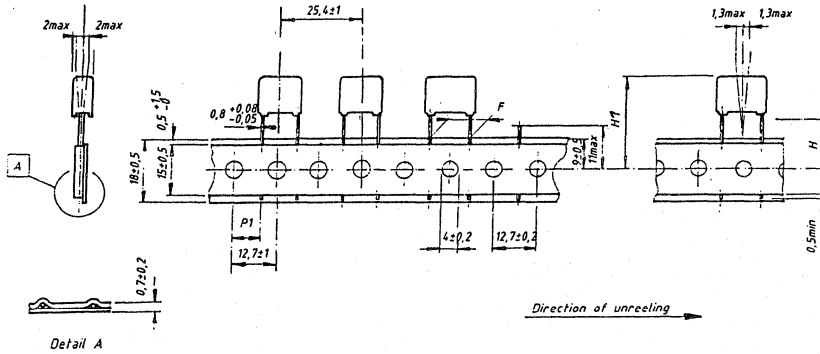

FOR PHYSICAL DIMENSIONS SEE PRODUCT SPECIFICATION

ITEM	SYMBOL	VALUE	VALUE	TOLERANCE
Lead to lead distance	F	10	15	+0.5/-0.1
Height of comp. from tape center to seating plane	H		18,5	±0,5
Component height from tape center	H1	max 32	max 35	for h = 18,5
Feed hole to leadcenter	P1	7,7	5,2	±0,7

Capacitors with terminal pitch P = 22,5 or 27,5mm, Fig. 8

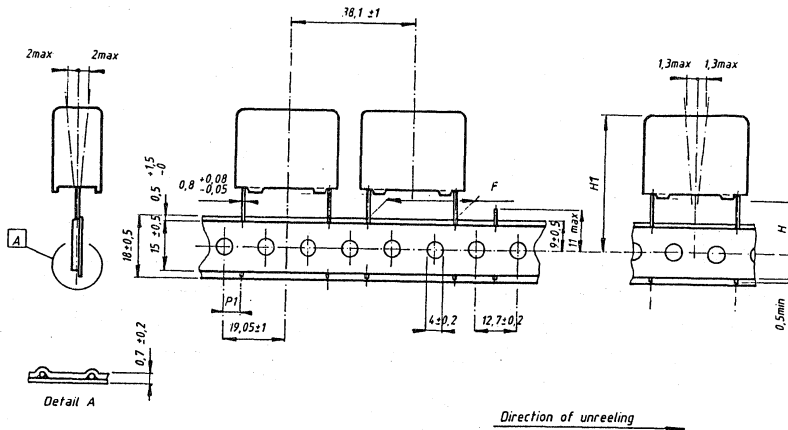

FOR PHYSICAL DIMENSIONS SEE PRODUCT SPECIFICATION

ITEM	SYMBOL	VALUE	VALUE	TOLERANCE
Lead to lead distance	F	22,5	27,5	+0.5/-0.1
Height of component from tape center to seating plane	H		18,5	±0,5
Component height from tape center	H1	max 40	max 48	for h=18,5
Feed hole to lead center	P1	7,8	5,33	±0,7

Metallized polyethyleneterephthalate film capacitors

2222 370/371/372/373

2. Characteristics of taped products.

Pull-out force of the component	> 5N
Pull-off force of the adhesive tape	> 6N
Tearing force of tape	> 15N
Storage conditions	
storage temperature	-25°C to +40°C
relative humidity	max. 80% without condensation

3. Outlines of reel and ammunition packing.

Style 2222 370, 2222 371

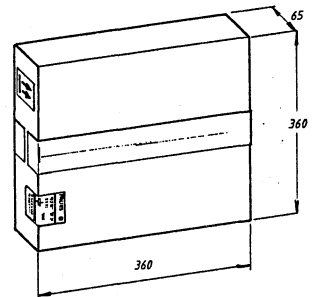
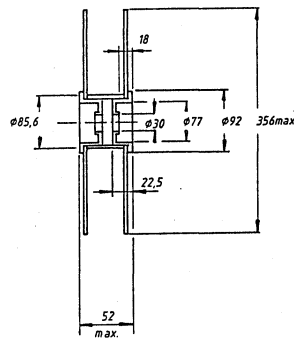
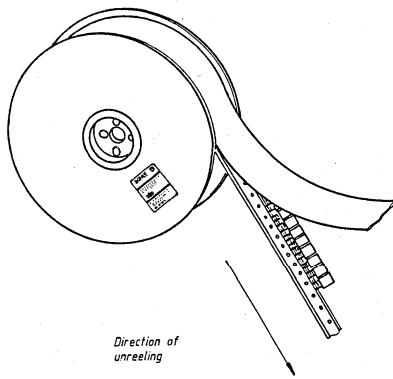
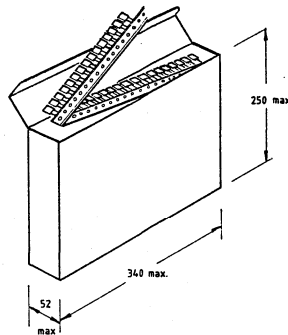

Fig. 9



**Metallized polyethyleneterephthalate
film capacitors**

2222 370/371/372/373

Style 2222 372, 2222 373

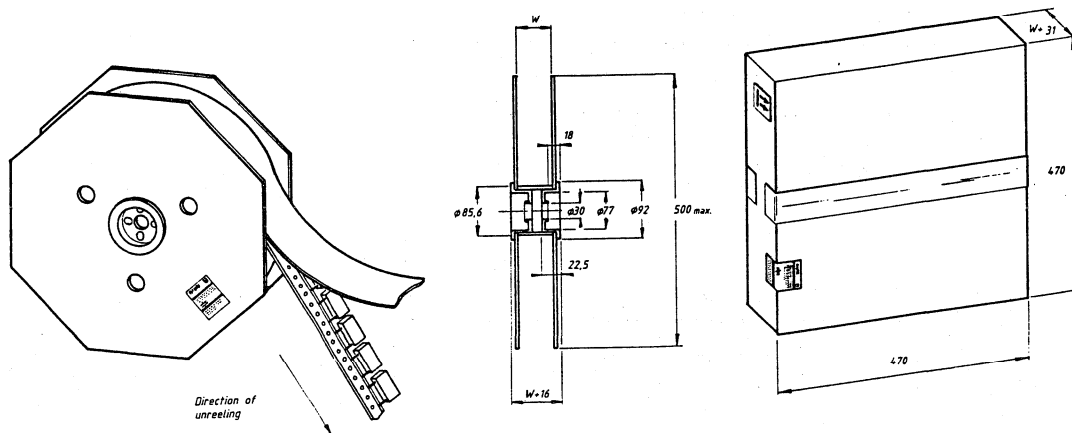

Fig. 10

Metallized polyethyleneterephthalate film capacitors

2222 370/371/372/373

4. Number of capacitors per reel and ammunition pack

Table 20 : l_{\max} 7,2 or 10mm.

b_{\max} mm	Number of capacitors per reel	Number of capacitors per ammopack
2,5	2000	2000
3	1500	
3,5	1500	1500
4	1500	
4,5	1000	1000
5	1000	1000
6	1000	750

Cumulative pitch error 1,0mm/20 pitches.

The max. number of empty places per reel shall not exceed 0,5% (*) of the total number of components per reel, but no more than 2 consecutive positions may be vacant.

* 5% for capacitors with b_{\max} : 4,5 - 5 or 6mm in ammunition pack.

Table 21 : l_{\max} 12,5 or 17,5 mm

b_{\max} mm	Number per reel	$W + 2$ mm
4	1400	40
5	1100	40
6	900	45
7	800	45
8,5	650	45

Table 22 : l_{\max} 26 or 31mm

b_{\max} mm	Number per reel	$W + 2$ mm
6	600	45
7	550	45
8,5	450	50
9	400	50
10	350	50
11	300	50
13	250	55
15	200	55
18	150	60
21	150	60

The max. number of empty places per reel shall not exceed 0,5% of the total number of components per reel, but a max. of 2 consecutive components may be missing provided this gap is followed by 6 consecutive components.

Metallized polyethyleneterephthalate film capacitors

2222 370/371/372/373

1.3. Ratings and characteristics

Unless otherwise specified all electrical values apply to an ambient free air temperature of $23 \pm 1^\circ\text{C}$, an atmospheric pressure of 86 to 106 kPa and a relative humidity of $50 \pm 2\%$.

1.3.1 Capacitance

Rated capacitance range at 1 kHz see Tables 1 to 18

Tolerance on rated capacitance see Tables 1 to 18

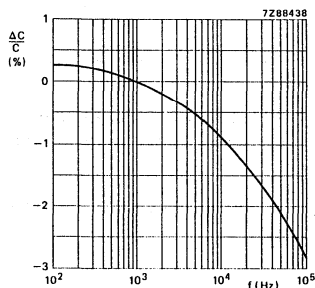

Fig.11: Capacitance as a function of frequency; typical curve.

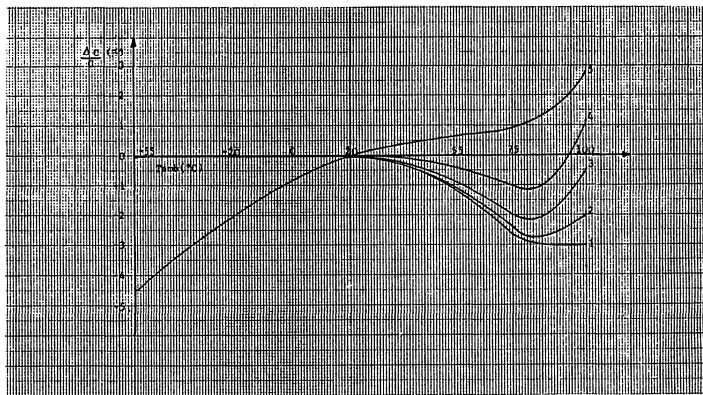

Fig.12: Capacitance as a function of ambient free air temperature measured at 1 kHz, typical curves.

1. 63 V series except for those of groupe 5
2. 100V series
3. 250V series
4. 400V series
5. 63 V series , 2222 370 , 0,27 to $1\mu\text{F}$

**Metallized polyethyleneterephthalate
film capacitors**

2222 370/371/372/373

1.3.2 Voltage

Rated voltage U_{Rdc}	See Tables 1 to 18
Category voltage U_C	$0,8 \times U_{Rdc}$
Test voltage between terminations	$1,6 \times U_{Rdc}$
between interconnected terminations and case(foil method)	$2 \times U_{Rdc}$; min. 200V
Max. a.c. voltage (r.m.s. value) at 50 to 60 Hz	See Tables 1 to 18

1.3.3 Climatic category 55/100/56

1.3.4 Rated temperature 85°C

1.3.5 Storage temperature range
Temperature -55°C to +100°C
RH max. 80% without
condensation

Metallized polyethyleneterephthalate film capacitors

2222 370/371/372/373

1.3.6. Tangent of loss angle

style	capacitance	tangent of loss angle		
		1kHz	10kHz	100kHz
2222 370	$C < 0,1\mu\text{F}$	$< 75 \times 10^{-4}$	$< 130 \times 10^{-4}$	$< 200 \times 10^{-4}$
	$0,1\mu\text{F} < C \leq 0,47\mu\text{F}$	$\leq 75 \times 10^{-4}$	$\leq 130 \times 10^{-4}$	$\leq 300 \times 10^{-4}$
371	$0,47\mu\text{F} < C \leq 1\mu\text{F}$	$\leq 75 \times 10^{-4}$	$\leq 130 \times 10^{-4}$	
2222 372	$C < 0,1\mu\text{F}$	$< 75 \times 10^{-4}$	$< 130 \times 10^{-4}$	$< 250 \times 10^{-4}$
	$0,1\mu\text{F} < C \leq 0,47\mu\text{F}$	$\leq 75 \times 10^{-4}$	$\leq 130 \times 10^{-4}$	$\leq 300 \times 10^{-4}$
373	$0,47\mu\text{F} < C \leq 1\mu\text{F}$	$\leq 75 \times 10^{-4}$	$\leq 130 \times 10^{-4}$	
	$1\mu\text{F} < C \leq 10\mu\text{F}$	$\leq 75 \times 10^{-4}$	$\leq 150 \times 10^{-4}$	
	$C > 10\mu\text{F}$	$\leq 75 \times 10^{-4}$		

Fig. 13 : Tan_delta as a function of frequency, typical curve

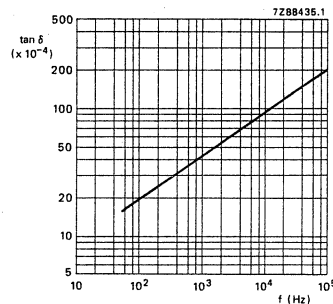

1.3.7. Rated voltage pulse slope $\left(\frac{dU}{dt}\right)_R$

rated voltage V	maximum pulse load (V/us)					
	l=7,2mm	l=10mm	l=12,5mm	l=17,5mm	l=26mm	l=31mm
63	60	18	16			
100	110	36	34	14	5	4
250	330	70	50	16	7	6
400	630	190	80	34	14	12

The maximum pulse load values in the table are valid for pulse voltages equal to the rated voltage.

For lower pulse voltages the given values may be multiplied by U_R /applied voltage.

Note :

If the pulse load requirement is satisfied, a check must be made to ascertain that the maximum dissipation is not exceeded.

Metallized polyethyleneterephthalate film capacitors

2222 370/371/372/373

1.3.8 Insulation resistance at $T_{amb} 20^{\circ}C$

The insulation resistance is measured after a voltage has been applied for 1 min. \pm 5 s., the voltage being 10 \pm 1V for the 63V version and 100V \pm 15V for the 100V, 250V and 400V versions.

R between terminations, for $C \leq 0,33\mu F$
 63V and 100V versions > 15 000 M Ω
 250V and 400V versions > 30 000 M Ω

RC between terminations, for $C > 0,33\mu F$
 63V and 100V versions > 5 000 s
 250V and 400V versions > 10 000 s

R between interconnected terminations and case > 30 000 M Ω
 (foil method)

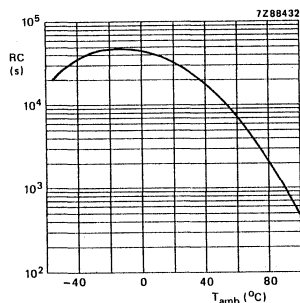

Fig. 14 : RC-product as a function of ambient free air temperature; typical curve

Metallized polyethyleneterephthalate film capacitors

2222 370/371/372/373

1.3.9 Maximum dissipation

The power dissipated by a capacitor is a function of the voltage U_{esr} across or the current I through the series resistance ESR and is expressed by:

$$P = \frac{U_{\text{esr}}^2}{\text{ESR}} \quad (1) \quad \text{or } P = \text{ESR} \cdot I^2 \quad (2)$$

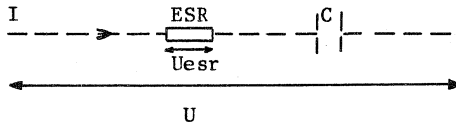

$$U_{\text{esr}}^2 = \frac{\text{ESR}^2}{\text{ESR}^2 + 1/\omega^2 C^2} \cdot U^2 \quad (3a)$$

As for film capacitors $\tan_{\text{delta}} = \omega \cdot C \cdot \text{ESR} \ll 0.1$, the formula (3a) can be simplified to

$$U_{\text{esr}}^2 = \text{ESR}^2 \cdot \omega^2 \cdot C^2 \cdot U^2 \quad (3b)$$

or with $\text{ESR} = \tan_{\text{delta}}/\omega C$, we become:

$$P = \omega \cdot C \cdot \tan_{\text{delta}} \cdot U^2 \quad (4) \quad \text{or } P = \frac{\tan_{\text{delta}}}{\omega \cdot C} I^2 \quad (5)$$

For the \tan_{delta} we can take the value found from fig.13, C is in farad and $\omega = 2 \cdot \pi \cdot f$.

U or I are assumed to be known.

The maximum permissible power dissipation (P_{max}), which depends on the dimensions of the capacitor and on the ambient free air temperature can be found from fig.15.

In applications where sine waves occur, we have to take for U the RMS-voltage or for I the RMS-current of the sine wave.

In applications where periodic signals occur, the signal has to be expressed in Fourier-terms:

$$U = U_0 + \sum_{k=1}^{\infty} \frac{1}{k+1} \sin(k\omega t + \varphi_k) \quad (6)$$

Metallized polyethyleneterephthalate film capacitors

2222 370/371/372/373

$$I = \sum_{k=1}^{\infty} I_k \sin(k\omega t + \varphi_k) \quad (7)$$

with U_0 the D.C.voltage, U_k and I_k the voltage resp. of the k-th harmonic.

We become for the dissipated power :

$$\text{with (6)} \quad P = \sum_{k=1}^{\infty} k \cdot \omega \cdot C \cdot \tan_{\Delta k} \frac{U_k^2}{2} \quad (8)$$

$$\text{with (7)} \quad P = \sum_{k=1}^{\infty} \frac{\tan_{\Delta k} \cdot I_k^2}{k \cdot \omega \cdot C \cdot 2} \quad (9)$$

and $\tan_{\Delta k}$ is the \tan_{Δ} at the k-th harmonic.

curve	dimensions (mm)		
	b_max	h_max	l_max
1	2,5	6,5	7,2
2	2,5	6,5	10
3	3,5	8	7,2
4	3	8	10
	4,5	9	7,2
5	5	10	7,2
	4	9	10
6	6	11	7,2
7	5	10,5	10
	4	9	12,5
8	4	10	12,5
9	6	12	10
10	5	11	12,5
11	6	12	12,5
12	5	11	17,5
13	6	12	17,5
14	7	13,5	17,5
15	8,5	15	17,5
16	6	15,5	26
17	7	16,5	26
18	8,5	18	26
19	10	19,5	26
20	11	21	31
21	13	23	31
22	15	25	31
23	18	28	31

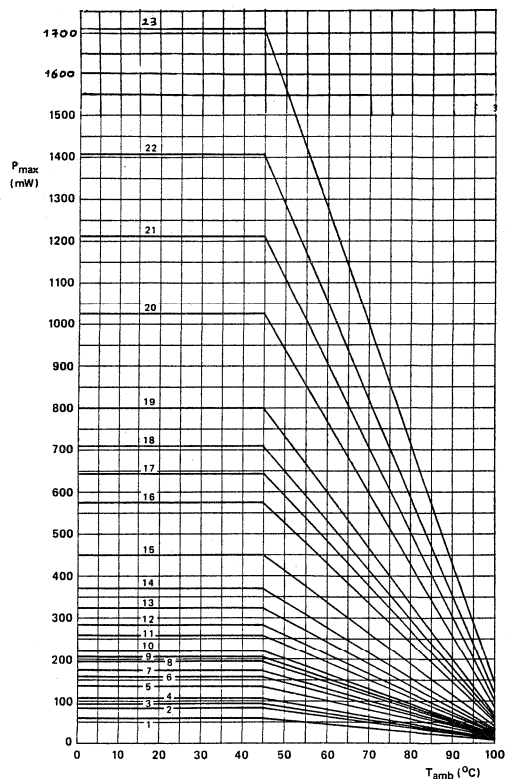

Fig. 15 : Maximum dissipation as a function of ambient free air temperature.

**Metallized polyethyleneterephthalate
film capacitors**

2222 370/371/372/373

1.3.10 Application note

To select this capacitor for a certain application you have to check 6 conditions :

1. The peak voltage (U_p) shall not be greater than the rated d.c. voltage.
2. The peak to peak voltage (U_{pp}) shall not be greater than $2\sqrt{2}$ times the rated a.c. voltage to avoid the ionisation inception level.
3. The peak current (I_p) shall not exceed the maximum peak current, defined as maximum voltage pulse slope (dU/dt) multiplied by the capacitance.

$$I_p \text{ max} = C \left(\frac{dU}{dt} \right) \text{ max.}$$

Or the voltage pulse slope shall not exceed the rated voltage pulse slope.

If the pulse voltage is lower than the rated voltage, the values of tabel 1.3.7 may be multiplied by U_{Rdc} and divided by applied voltage.

4. The dissipated power shall not be greater than the maximum permissible power dissipation stated in 1.3.9.
5. The free air ambient temperature for the capacitor is not exceeding the category temperature.
6. In applications where voltages higher than 50V are applied, it is recommended that the power in the capacitor be limited to 2,5 VA in case of a capacitor failure.

Metallized polyethyleneterephthalate film capacitors

2222 370/371/372/373

Example of using Fig. 13 and 15

A capacitor of 0,1 μ F should be used at a sine voltage of 10Vrms, a frequency of 10kHz and an ambient free air temperature of 50°C.

The \tan_{delta} is 0.01 (from Fig. 13), so that the power to be dissipated is :

$$\begin{aligned} P &= w.C.\tan_{\text{delta}} \cdot U^2 \\ &= 2.\pi.10^{-4} \times 0,1 \cdot 10^{-6} \times 0.001 \cdot 100W \\ &= 6,3 \text{ mW} \end{aligned}$$

For a rated voltage of 10 Vac a capacitor of the 63V range is required at least.

Capacitor 0,1 μ F/63V is satisfactory because of its dimensions 2,5 x 6,5 x 7,2mm and its dissipated power of 57 mW at 50°C.

Checking the 6 conditions

1. The peak voltage $U_p = 14 (\sqrt{2} \times 10)$ is lower than 63Vdc.
2. The peak to peak voltage $28U_{pp}$ is lower than 25Vac $2\sqrt{2} = 70 U_{pp}$
3. Because of the sinewave, we have not to check the pulse conditions.
4. The dissipated power is : 6,3mW
This is less than 57 mW at 50°C for its dimensions 2,5 x 6,5 x 7,2 seen in Fig. 15.
5. The free air ambient temperature is 50°C, and lower than 100°C.
6. In case of failure, the power is switched off.

**Metallized polyethyleneterephthalate
film capacitors****2222 370/371/372/373****1.4. Related documents :**

Generic specification IEC 384-1
Sectional specification IEC 384-2

1.5. Marking**1.5.1. Style 2222 370, 2222 371, 2222 372**

The capacitors are marked on the top with the following information :

° Capacitance p : pF n : nF μ : μ F
° Capacitance tolerance M : 20% K : 10% J : 5%

The capacitors are marked on the side with the following information :

° Rated voltage (e.g. 100V)
° Code for dielectric material (MKT)
° Code for factory of origin (HQ)
° Manufacturer's type designation (e.g. 372)
° Manufacturer's identification (PH)
° Year and week of manufacture (e.g. 9010)

Example : 100n K 100V
 MKT-HQ
 372-PH

1.5.2. Style 2222 373

Capacitors with l_{max} 17,5mm

The capacitors are marked on the top by embossed print with the following information :

° Capacitance n : nF μ : μ F
° Rated voltage (e.g. 100)
° Capacitance tolerance K : 10% J : 5%
° Manufacturer's type designation (373)
° Code for dielectric material (MKT)
° Code for factory of origin (HQ)
° Production date code acc. to IEC 62, clause 5 (e.g. A1)
° Manufacturer's identification symbol 

Example :  470n K 100
 373 MKT .. HQ

Capacitors with l_{max} 26 or 31mm

The capacitors are marked on the top by laser print with the following information :

° Capacitance n : nF μ : μ F
° Rated voltage (e.g. 100V)
° Capacitance tolerance K : 10% J : 5%
° Manufacturer's name (PHILIPS)
° Manufacturer's type designation (373)
° Code for dielectric material (MKT)
° Code for factory of origin (HQ)
° Year and week of manufacture (e.g. 9010)

Example : 2 μ 2 K 100V PHILIPS
 373 MKT HQ

Metalized polyethyleneterephthalate film capacitors

2222 370/371/372/373

The package containing the capacitors is marked as follows

Data on label SPQ and PQ
(example)

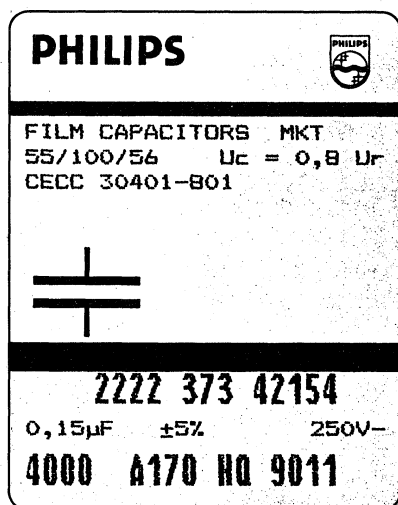

Block A : Philips word mark and emblem

Block B : Line 1 : Film capacitors and material code
Line 2 : Climatic group number and category voltage
Line 3 : Country standard

Capacitor symbol

Block C : Line 1 : Product code (12 NC)

Line 2 : Capacitance value
<10nF in pF followed by pF
>10nF in µF followed by µF
Tolerance followed by + and %
Voltage followed by V-

Line 3 : Number of capacitors
Preference-origin code : A
Country of origin : Belgium=170
Responsible production centre :
Philips Roeselare = HQ
Production period : year- and week code (4 digits)

1.6. Ordering information

Order the capacitors by quoting the 12-digit catalogue number as shown in Tables 1 to 18.

1.7. Certified test records (CTR)

Not required for the types with Qualification Approval according to CECC 30401-801.

**Metalized polyethyleneterephthalate
film capacitors**

2222 370/371/372/373

2. INSPECTION REQUIREMENTS

Note 1 : Sub-clause numbers of tests and performance requirements refer to the Sectional Specification, IEC-publication 384-2 and Section One of this specification.

Note 2 : Inspection levels and AQL's are selected from IEC-Publication 410 : Sampling Plans and Procedures for Inspection by attributes.

Note 3 : In this table : p = periodicity (in months)
 n = sample size
 c = acceptance criterion (permitted number of defectives)
 D = destructive
 ND = non-destructive
 IL = inspection level) IEC 410
 AQL = acceptable quality level)

Note 4 : For the type ranges with CECC Qualification Approval separate periodic C-tests are carried out as prescribed by the CECC Detail specification.

Note 5 : For this capacitor, considered as a solid construction, it is permitted to reduce the periodicity of the vibration and shock test from 6 months to 36 months.
In the event of a single defective occurring in subgroup Clb at this reduced rate of testing, then the vibration and shock tests shall revert to a 6 monthly periodicity until three successive 6-monthly tests shall have produced no defectives.

**Metallized polyethyleneterephthalate
film capacitors**

2222 370/371/372/373

Clause number and Test (see Note 1)	D or ND	Conditions of Test (see Note 1)	IL (see Note 2)	AQL	Performance requirements
<u>Group A Inspection (lot-by-lot)</u>					
<u>Sub-group A1</u>					
4.1 Visual examination	ND		I	2,5%	- No mechanical failures - Legible marking and as specified in GENERAL DATA of this specification.
4.2 Dimensions		Gauging			- As specified in Tables in GENERAL DATA
<u>Sub-group A2</u>					
4.2.1 Voltage proof (Test A)	ND	at $1,6xU_{Rdc}$ for 1s.	II	1%	- No breakdown or flashover
4.2.2 Capacitance		at 1kHz			- Within specified tolerance
4.2.3 Tangent of loss angle		$< 470nF$ at 100kHz $470 nF < C < 10\mu F$ at 10 kHz $C > 10\mu F$ at 1 kHz			- As in GENERAL DATA of this specification
4.2.4 Insulation resistance (Test A)		at 10V for $U_R = 63V$ at 100V for $U_R = 100V$ 250V 400V			- As in GENERAL DATA of this specification
<u>Group B Inspection</u>					
Lot by lot for CECC assessed types (For the other types see periodic tests)					
4.5 <u>Solderability</u>	D	Without ageing Methode : 1 Solder bath : 235°C	S3	2,5%	Good tinning as evidenced by free flowing of the solder with wetting of the terminations

Metallized polyethyleneterephthalate film capacitors

2222 370/371/372/373

Sub-clause number and Test (see Note 1)	D or ND	Conditions of test (see Note 1)	Sample size + criterion of accepta- bility (see Note 3)			Performance requirements
			p	n	c	
<u>Group C inspection</u> (periodic)(see note 4)						
<u>Sub-group C1A</u> Part of sample of Sub-group C1	D		6	9	1	
4.1 Dimensions (detail)						As specified in GENERAL DATA
4.3.1 Initial measurements		Capacitance Tangent of loss angle for < 470nF at 100kHz 470 nF < C < 10µF at 10 kHz C > 10µF at 1 kHz				
4.3 Robustness of terminations		Tensile and bending				No visible damage
4.4 Resistance to soldering heat		Methode : 1A Solder bath : 260°C Duration : Style 2222 370 : C < 10nF : 5s Other capacitors : 10s				
4.14 Component solvent resistance		Mixture 1,1,2- trichlorotrifluoro- ethane and 2 - propanol(isopro- pylalcohol) boiling temperature 48,6 to 50,5°C Method : 2 Immersion time : 5 ± 0,5 min. Recovery time : min. 1h max. 2h Visual examination				
4.4.2 Final measurements		Capacitance Tangent of loss angle				No visible damage Legible marking $\frac{\Delta C}{C}$ < 2% of the va- lue measured initially Increase of tan delta < 0,005 for C < 100nF < 0,01 for C > 100nF < 220nF < 0,015 for C > 220nF < 470nF < 0,003 for C > 470nF compared to values measured in 4.3.1

Metallized polyethyleneterephthalate film capacitors

2222 370/371/372/373

Sub-clause number and Test (see Note 1)	D or ND	Conditions of test (see Note 1)	Sample size + criterion of accepta- bility (see Note 3)			Performance requirements
			p	n	c	
Sub-group ClB Other part of sample of Sub-group Cl 4.6.1 Initial measurements	D	Capacitance Tangent of loss angle for < 470nF at 100kHz 470 nF < C ≤ 10μF at 10 kHz C > 10μF at 1 kHz	6	18	1	
4.6 Rapid change of temperature		θ A=lower cat. temp. θ B=upper cat. temp. 5 cycles Duration t = 30min. Visual examination				No visible damage
4.7 Vibration (see Note 5)		Method of mounting see GENERAL DATA of this specification. Procedure B4. Frequency range : 10Hz to 55Hz. Amplitude:0,75mm or acceleration 98m/s ² (whichever is the less severe) Total duration:6h				
4.7.2 Final inspection		Visual examination				No visible damage
4.9 Shock (see Note 5)		Method of mounting see GENERAL DATA of this specification Pulse shape : half sine Accelerat.:490m/s ² Duration of pulse : 11ms				
4.9.3 Final measurements		Visual examination Capacitance				No visible damage $\frac{\Delta C}{C} \leq 3\%$ of the va- lue measured in 4.6.1

**Metallized polyethyleneterephthalate
film capacitors**

2222 370/371/372/373

Sub-clause number and Test (see Note 1)	D or ND	Conditions of test (see Note 1)	Sample size + criterion of accepta- bility (see Note 3)			Performance requirements
			p	n	c	
		Tangent of loss angle				Increase of tan delta for C < 100nF <0,01 for style 2222 370/371 < 0,005 for style 2222 372/373 <0,01 for C >100nF <220nF <0,015 for C >220nF <470nF <0,003 for C >470nF compared to values measured in 4.6.1 As in GENERAL DATA of this specifi- cation.
<u>Sub-group C1</u>	D		6	27	2	
Combined sample of spe- cimens of Sub-groups C1A and C1B						
4.10 Climatic sequence						
4.10.2 Dry heat		Temperature : upper category temperature Duration : 16h				
4.10.3 Damp heat cyclic, Test Db, first cycle						
4.10.4 Cold		Temperature : lower category temperature Duration : 2h				
4.10.6 Damp heat cyclic, Test Db, remaining cycles						
4.10.6.2 Final measurements		Visual examination Capacitance				No visible damage Legible marking $\Delta \frac{C}{C} \leq 3\%$ of value measured in 4.4.2. or 4.9.3.

**Metallized polyethyleneterephthalate
film capacitors**

2222 370/371/372/373

Sub-clause number and Test (see Note 1)	D or ND	Conditions of test (see Note 1)	Sample size + criterion of accepta- bility (see Note 3)			Performance requirements
			p	n	c	
		Tangent of loss angle				Increase of tan δ for C < 100nF <0,01 For style 2222 370/371 < 0,005 for style 2222 372/373 <0,01 for C >100nF <220nF <0,015 for C >220nF <470nF <0,005 for C >470nF compared to values measured in 4.3.1 or 4.6.1
		Insulation resistance				>50% of values in GENERAL DATA of this specification
<u>Sub-group C2</u> 4.11 Damp heat steady state	D		6	15	1	
4.11.1 Initial measurements		Capacitance Tangent of loss angle for < 470nF at 100kHz 470 nF < C ≤ 10μF at 10 kHz C > 10μF at 1 kHz				
4.11.3 Final measurements		Visual examination Capacitance Tangent of loss angle				No visible damage Legible marking ΔC <5% of the value measured in 4.11.1 Increase of tan δ <0,007 for C <100nF <0,01 for C >100nF <220nF <0,015 for C >220nF <470nF <0,005 for C >470nF Compared to values measured in 4.11.1

**Metallized polyethyleneterephthalate
film capacitors**
2222 370/371/372/373

Sub-clause number and Test (see Note 1)	D or ND	Conditions of test (see Note 1)	Sample size + criterion of accepta- bility (see Note 3)			Performance requirements
			p	n	c	
		Insulation resistance				>50% of values in GENERAL DATA of this specification
<u>Sub-group C3</u>	D		3	21	1	
4.12 Endurance		Duration : 2000h 1,25 U _{Rdc} at 85°C 1,25 U _C at 100°C				
4.12.1 Initial measurements		Capacitance Tangent of loss angle for < 470nF at 100kHz 470 nF < C _R ≤ 10μF at 10 kHz C > 10μF at 1 kHz				
4.12.5 Final measurements		Visual examination Capacitance Tangent of loss angle Insulation resistance				No visible damage Legible marking Style 2222 370/371 $\frac{\Delta C}{C} < 3 \%$ Style 2222 372/373 $\frac{\Delta C}{C} < 5 \%$ measured in 4.12.1 Increase of tan delta for C ≤ 100nF for style 2222 370 and 371 < 0,005 at 85°C < 0,01 at 100°C < 0,005 for style 2222 372 and 373 < 0,01 for C > 100nF < 220nF < 0,015 for C > 220nF < 470nF < 0,003 for C > 470nF compared to values measured in 4.12.1 >50% of values in GENERAL DATA of this specification

**Metallized polyethyleneterephthalate
film capacitors**

2222 370/371/372/373

Sub-clause number and Test (see Note 1)	D or ND	Conditions of test	Sample size + criterion of accepta- bility			Performance requirements
			p	n	c	
<u>Sub-group C4</u>	D		3	9	1	
4.13 Charge and discharge		10 000cycles(50 c/s) charge to U _R half sine wave Duration : 5 ms discharge R = $\frac{U_R}{C 2,5 \left(\frac{dU}{dt} \right)_R}$ with a min. of 2,2Ω				
4.13.1 Initial measurements		Capacitance Tangent of loss angle for < 470nF at 100kHz 470 nF < C < 10μF at 10 kHz C > 10μF at 1 kHz				
4.13.3 Final measurements		Capacitance Tangent of loss angle Insulation resistance				$\frac{\Delta C}{C} < 3\%$ of value measured in 4.13.1 Increase of tan delta <0,005 for C <100nF <0,01 for C >100nF <220nF <0,015 for C >220nF <470nF <0,003 for C >470nF > 50% of values in GENERAL DATA of this specification

**Metallized polyethyleneterephthalate
film capacitors**

2222 370/371/372/373

Additional tests	D or ND	Conditions of test	Sample size + criterion of accepta- bility			Performance requirements
			p	n	c	
<hr/>						
<p><u>Sub-group ADD1</u> A.1 Solderability</p> <p>Solvent resistance of the marking</p>	D	<p>Without ageing Method :1 Non-activated colo- phony flux 501 Solder bath 235°C Dwell time : 2 s. Mixture 1,1,2- trichlorotrifluoro- ethane and 2- propanol (isopropylalcohol) Boiling temperature 48,6°C to 50,5°C Method 1 Rubbing material : cotton wool Immersion time : 5 ± 0,5 min.</p>	3	35	1	<p>Good tinning as evidenced by free flowing of the solder with wet- ting of the ter- minations (>95%)</p> <p>Legible marking</p>
<hr/>						
<p><u>Sub-group ADD2</u> A.2 Heat storage</p> <p>A.2.1 Initial measurements</p> <p>A.2.2 Final measurements</p>	D	<p>Duration : 2000h Temperature : upper category temperature Capacitance Tangent of loss angle for < 470nF at 100kHz 470 nF < C < 10µF at 10 kHz C > 10µF at 1 kHz Capacitance</p> <p>Tangent of loss angle</p> <p>Insulation resistance</p>	3	12	1	<p>$\frac{\Delta C}{C} < 3\%$ of value measured in A.2.1 Increase of tan delta for C < 100nF <0,01 for style 2222 370 and 371 <0,005 for style 2222 372 and 373 <0,01 for C >100nF <220nF <0,015 for C >220nF <470nF <0,003 for C >470nF compared to values measured in A.2.1 As in GENERAL DATA of this specifi- cation.</p>

Metallized polyethyleneterephthalate film capacitors

2222 370/371/372/373

Additional tests	D or ND	Conditions of test	Sample size + criterion of accepta- bility			Performance requirements
			p	n	c	
Sub-group ADD3			3	9	1	
A.3 Endurance for capacitors with max. a.c. voltage $\geq 200V$ (r.m.s.)		Duration : 1000h Temperature : 85°C Voltage: 1,25 x max. a.c. voltage (r.m.s. value), 50Hz				
A.3.1 Initial measurements		Capacitance Tangent of loss angle for $C < 470nF$ at 100kHz $470 nF < C \leq 10\mu F$ at 10 kHz $C > 10\mu F$ at 1 kHz				
A.3.2 Final measurements		Capacitance				Style 2222 370/371 $\frac{\Delta C}{C} < 5\%$
		Tangent of loss angle				Style 2222 372/373 $\frac{\Delta C}{C} < 3\%$ of value measured in A.3.1 Increase of $\tan \delta$ $< 0,005$ for $C < 100nF$ $< 0,01$ for $C > 100nF$ $< 220nF$ $< 0,015$ for $C > 220nF$ $< 470nF$ $< 0,003$ for $C > 470nF$ compared to values measured in A.3.1
		Insulation resistance				As in GENERAL DATA of this specification.

**Metallized polyethyleneterephthalate
film capacitors**

2222 370/371/372/373

Additional tests	D or ND	Conditions of test	Sample size + criterion of accepta- bility			Performance requirements
			p	n	c	
<u>Sub-group ADD4</u>	D		6	15	1	
A.4 Resistance to soldering heat with pre-heating.		Capacitors mounted on a 1,6mm board with nonplated holes Body temp. : 80°C Bath temp. : 260°C Dwell time : 5s				
A.4.1 Initial measurements		Capacitance Tangent of loss angle for < 470nF at 100kHz 470 nF < C ≤ 10μF at 10 kHz C > 10μF at 1 kHz				
A.4.2 Final measurements		Capacitance Tangent of loss angle				$\frac{\Delta C}{C} < 2\%$ for $b_{max} = 2,5mm$ $\frac{\Delta C}{C} < 1\%$ for $b_{max} > 2,5 mm$ of value measured in A.4.1 Increase of tan delta $< 0,005$ for $C < 100nF$ $< 0,01$ for $C > 100nF$ $< 220nF$ $< 0,015$ for $C > 220nF$ $< 470nF$ $< 0,003$ for $C > 470nF$ compared to values measured in A.4.1

Metallized polyethyleneterephthalate film capacitors

2222 370/371/372/373

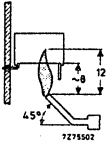
Additional tests	D or ND	Conditions of test	Sample size + criterion of acceptability			Performance requirements
			p	n	c	
<hr/>						
<u>Sub-group ADD5</u>	D		6	15	1	
A.5.1 Needle flame test IEC 40 (secr.)580 Class C For styles 2222 372/373		Bore of gas jet : \varnothing 0,5 mm Fuel : butane Test duration for actual volume V (mm ³) : $< 250 : 5s$ $250 < V < 500 = 10s$ $500 < V < 1750 = 20s$ $V > 1750 = 30s$ One flame application.				After removing the test flame from the capacitor, the capacitor must not continue to burn for more than 30s, no burning particles must drop from the sample.
						
<hr/>						
<u>Sub-group Add6</u>			3	15	0	
A.6 Climatic test on taped type		10 days at 40 +2°C R.H. 90 to 95% Recovery time : 24h				Change in position of lead hole over 20 pitch distances $< 0,5mm$. Angle of component $< 4^\circ$. Pull out and tearing forces $> 50\%$ of values in GENERAL DATA of this specification

**Metallized polyethyleneterephthalate
film capacitors**

2222 370/371/372/373

Additional tests	D or ND	Conditions of test	Sample size + criterion of acceptability			Performance requirements																									
			p	n	c																										
<p><u>Sub-group ADD8</u> A.8 Charge and discharge acc. to DIN 44 122</p> <p>For styles 2222 372/373</p>	D	<p>20.000 cycles (50 c/s) charge to U_R half sinus wave duration : 5 ms Discharge $R = \frac{RC}{C}$</p>	3	9	1																										
		<table border="1"> <thead> <tr> <th>U_R</th> <th colspan="4">RC</th> </tr> <tr> <td></td> <th>l=12,5mm</th> <th>l=17,5mm</th> <th>l= 26mm</th> <th>l= 31mm</th> </tr> </thead> <tbody> <tr> <td>100V</td> <td>1,7</td> <td>3,3</td> <td>5</td> <td>7</td> </tr> <tr> <td>250V</td> <td>2,5</td> <td>5</td> <td>8,3</td> <td>10</td> </tr> <tr> <td>400V</td> <td>2,9</td> <td>5,7</td> <td>10</td> <td>13</td> </tr> </tbody> </table>	U_R	RC					l=12,5mm	l=17,5mm	l= 26mm	l= 31mm	100V	1,7	3,3	5	7	250V	2,5	5	8,3	10	400V	2,9	5,7	10	13				
U_R	RC																														
	l=12,5mm	l=17,5mm	l= 26mm	l= 31mm																											
100V	1,7	3,3	5	7																											
250V	2,5	5	8,3	10																											
400V	2,9	5,7	10	13																											
A.8.1 Initial measurements		<p>Capacitance Tangent of loss angle for < 470nF at 100kHz 470 nF < C < 10µF at 10 kHz C > 10µF at 1 kHz</p>																													
A.8.2 Final measurements		<p>Capacitance Tangent of loss angle Insulation resistance</p>				<p>$\frac{\Delta C}{C} \leq 3\%$ of value measured in A.8.1 Increase of tan delta < 0,005 for C < 100nF < 0,01 for C > 100nF < 220nF < 0,015 for C > 220nF < 470nF < 0,003 for C > 470nF > 50% of values in GENERAL DATA of this specification</p>																									

Philips Components

Data sheet	
status	Products specification
date of issue	May 1990

2222 365/366/367/368/369

Metallized polyethyleneterephthalate film capacitors

MKT Radial epoxy lacquered types

- ° 5,08 to 27,94mm terminal pitch
- ° Supplied loose in box and taped

QUICK REFERENCE DATA

Capacitance range (E12-series)	0,001 to 6,8 μ F
Capacitance tolerance	<u>+</u> 20%, <u>+</u> 10%, <u>+</u> 5%
Rated voltage (d.c.)	63V, 100V, 250V, 400V, 630V
Climatic category	40/100/56
Rated temperature	85°C
Tangent of loss angle at 10kHz	100 x 10 ⁻⁴
Related specification	IEC 384-2
Performance grade	Grade 1 (long life)

**Metallized polyethyleneterephthalate
film capacitors**

2222 365/366/367/368/369

SURVEY OF STYLES

	Style	Terminal pitch	Tables
	2222 365	5,08mm	1 to 6
	2222 366	5,08mm; 7,62mm	7 to 12
	2222 367	5,08mm; 7,62mm	18 to 23
	2222 368	10,16 to 27,94mm	13 to 17
	2222 369	10,16mm	24 to 28

CONSTRUCTION

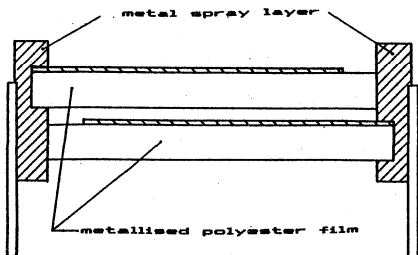

**Metallized polyethyleneterephthalate
film capacitors**

2222 365/366/367/368/369

APPLICATION

In electronic circuits for blocking and coupling, bypass and energy reservoir applications. Their small dimensions make them suitable for circuits with high packaging density.

DESCRIPTION

The capacitors consist of a low-inductive wound cell of metallized polyethyleneterephthalate film. The cell is protected by a hard, water repellent, solvent resistant epoxy lacquer. The radial leads are of solder-coated wire.

1. GENERAL DATA

1.1. Mounting

Normal use

The capacitors are designed for printed wiring applications.

The capacitors packed in bandoliers are designed for mounting on printed-wiring boards by means of automatic insertion machines.

Specified method of mounting to withstand vibration and shock

In order to withstand vibration and shock tests, it must be ensured that the underside of the crimps are in good contact with the printed-wiring board. For case sizes up to and including a mass of 2 g the capacitors shall be mechanically fixed by the leads. With larger case sizes the capacitors shall be mounted in the same way and the body shall be clamped.

Metallized polyethyleneterephthalate film capacitors

2222 365/366/367/368/369

1.2.1 Dimensions in mm

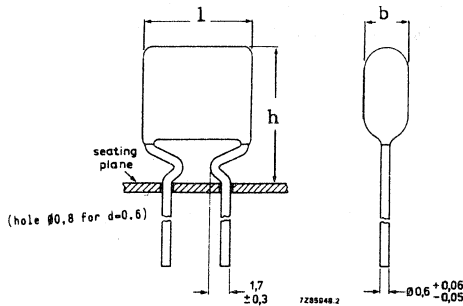

Fig. 1

For drawing with tape instructions see Fig. 6

Table 1 $U_{Rdc} = 63V$; max. a.c. voltage = 40V, Fig. 1

capacitance μF	b_{max}	h_{max}	l_{max}	P	mass g	catalogue number 2222 365					
						taped on reel			ammopack		
						C-tol $\pm 20\%$	C-tol $\pm 10\%$	C-tol $\pm 5\%$	C-tol $\pm 20\%$	C-tol $\pm 10\%$	C-tol $\pm 5\%$
0,047						70473	71473	72473	74473	75473	76473
0,056						70563	71563	72563	74563	75563	76563
0,068	3,5	12,5		5,08	0,3	70683	71683	72683	74683	75683	76683
0,082						70823	71823	72823	74823	75823	76823
0,1						70104	71104	72104	74104	75104	76104
0,12						70124	71124	72124	74124	75124	76124
0,15	4	13				70154	71154	72154	74154	75154	76154
0,18	4,5	13,5	7,5		0,3	70184	71184	72184	74184	75184	76184
0,22	4,5	13,5				70224	71224	72224	74224	75224	76224
0,27	5	14				70274	71274	72274	74274	75274	76274
0,33	5,5	14,5			0,4	70334	71334	72334	74334	75334	76334
0,39	5,5	14,5				70394	71394	72394	74394	75394	76394
0,47	6	15,5				70474	71474	72474	74474	75474	76474
0,56	5,5	14				70564	71564	72564	74564	75564	76564
0,68	5,5	14,5				70684	71684	72684	74684	75684	76684
0,82	6	15				70824	71824	72824	74824	75824	76824
1	6,5	15,5			0,5	70105	71105	72105	74105	75105	76105

$\pm 5\%$ available on request

Metallized polyethyleneterephthalate film capacitors

2222 365/366/367/368/369

Table 2 $U_{Rdc} = 63V$; max. a.c. voltage = 40V, Fig. 1

capacitance μF	b_max	h_max	l_max	P	mass g	catalogue number 2222 365					
						taped on reel			ammopack		
						C-tol + 20%	C-tol + 10%	C-tol + 5%	C-tol + 20%	C-tol + 10%	C-tol + 5%
0,12					0,4	10124	11124	12124	14124	15124	16124
0,15				5,08	0,4	10154	11154	12154	14154	15154	16154
0,18	4	13,5	10	+	0,4	10184	11184	12184	14184	15184	16184
0,22				0,3	0,4	10224	11224	12224	14224	15224	16224
0,27	4,5	14			0,5	10274	11274	12274	14274	15274	16274
0,33	5	14,5			0,5	10334	11334	12334	14334	15334	16334
0,39	5	14,5			0,6	10394	11394	12394	14394	15394	16394
0,47	5,5	15				10474	11474	12474	14474	15474	16474
0,56	5,5	15	10,5		0,7	10564	11564	12564	14564	15564	16564
0,68	5,5	15				10684	11684	12684	14684	15684	16684
0,82	5,5	15				10824	11824	12824	14824	15824	16824
1	5,5	15				10105	11105	12105	14105	15105	16105

Table 3 $U_{Rdc} = 100V$; max. a.c. voltage = 63V, Fig. 1

capacitance μF	b_max	h_max	l_max	P	mass g	catalogue number 2222 365					
						taped on reel			ammopack		
						C-tol + 20%	C-tol + 10%	C-tol + 5%	C-tol + 20%	C-tol + 10%	C-tol + 5%
0,01						80103	81103	82103	84103	85103	86103
0,012						80123	81123	82123	84123	85123	86123
0,015				5,08		80153	81153	82153	84153	85153	86153
0,018				+		80183	81183	82183	84183	85183	86183
0,022	3,5	12,5	7,5	0,3	0,3	80223	81223	82223	84223	85223	86223
0,027						80273	81273	82273	84273	85273	86273
0,033						80333	81333	82333	84333	85333	86333
0,039						80393	81393	82393	84393	85393	86393
0,047	3,5	12,5				80473	81473	82473	84473	85473	86473
0,056	3,5	12,5				80563	81563	82563	84563	85563	86563
0,068	3,5	12,5	7,5			80683	81683	82683	84683	85683	86683
0,082	4	13				80823	81823	82823	84823	85823	86823
0,10	4,5	13,5			0,4	80104	81104	82104	84104	85104	86104

+ 5% available on request

**Metallized polyethyleneterephthalate
film capacitors**
2222 365/366/367/368/369
Table 4 $U_{Rdc} = 100V$; max. a.c. voltage = 63V, Fig. 1

capacitance μF	b_max	h_max	l_max	P	mass g	catalogue number 2222 365					
						taped on reel			ammopack		
						C-tol + 20%	C-tol + 10%	C-tol + 5%	C-tol + 20%	C-tol + 10%	C-tol + 5%
0,039						20393	21393	22393	24393	25393	26393
0,047						20473	21473	22473	24473	25473	26473
0,056				5,08		20563	21563	22563	24563	25563	26563
0,068				+		20683	21683	22683	24683	25683	26683
0,082	4	13,5	10	0,3	0,4	20823	21823	22823	24823	25823	26823
0,10						20104	21104	22104	24104	25104	26104
0,12	4,5	14			0,5	20124	21124	22124	24124	25124	26124
0,15	5	14,5			0,5	20154	21154	22154	24154	25154	26154
0,18	5	14,5	10,5		0,6	20184	21184	22184	24184	25184	26184
0,22	5,5	15			0,7	20224	21224	22224	24224	25224	26224
0,27	6	15,5				20274	21274	22274	24274	25274	26274
0,33	6	15,5				20334	21334	22334	24334	25334	26334
0,39	6	15,5			0,7	20394	21394	22394	24394	25394	26394
0,47	6	15,5				20474	21474	22474	24474	25474	26474

Table 5 $U_{Rdc} = 250V$; max. a.c. voltage = 160V, Fig. 1

capacitance μF	b_max	h_max	l_max	P	mass g	catalogue number 2222 365					
						taped on reel			ammopack		
						C-tol + 20%	C-tol + 10%	C-tol + 5%	C-tol + 20%	C-tol + 10%	C-tol + 5%
0,018				5,08		40183	41183	42183	44183	45183	46183
0,022				+		40223	41223	42223	44223	45223	46223
0,027	4	13,5	10	0,3	0,4	40273	41273	42273	44273	45273	46273
0,033						40333	41333	42333	44333	45333	46333
0,039						40393	41393	42393	44393	45393	46393
0,047						40473	41473	42473	44473	45473	46473

**Metallized polyethyleneterephthalate
film capacitors**
2222 365/366/367/368/369
Table 6 $U_{Rdc} = 400V$; max. a.c. voltage = 220V, Fig. 1

capaci- tance μF	b_max	h_max	l_max	P	mass g	catalogue number 2222 365					
						taped on reel			ammopack		
						C-tol + 20%	C-tol + 10%	C-tol + 5%	C-tol + 20%	C-tol + 10%	C-tol + 5%
0,0033						50332	51332	52332	54332	55332	56332
0,0039						50392	51392	52392	54392	55392	56392
0,0047				5,08		50472	51472	52472	54472	55472	56472
0,0056				+		50562	51562	52562	54562	55562	56562
0,0068	4	13,5	10	0,3	0,4	50682	51682	52682	54682	55682	56682
0,0082						50822	51822	52822	54822	55822	56822
0,010						50103	51103	52103	54103	55103	56103
0,012						50123	51123	52123	54123	55123	56123
0,015						50153	51153	52153	54153	55153	56153

Metallized polyethyleneterephthalate film capacitors

2222 365/366/367/368/369

Dimensions in mm

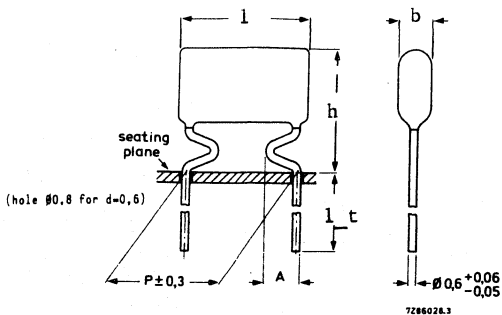

Fig. 2

Table 7 $U_{Rdc} = 63V$; max. a.c. voltage = 40V, Fig. 2

capacitance μF	b_{max}	h_{max}	l_{max}	A	P	mass g	catalogue number 2222 366					
							loose in box					
							$l_t = 17 \pm 4$			$l_t = 4 \pm 1,0 - 0,5$		
							C-tol $\pm 20\%$	C-tol $\pm 10\%$	C-tol $\pm 5\%$	C-tol $\pm 20\%$	C-tol $\pm 10\%$	C-tol $\pm 5\%$
0,047							70473	71473	72473	74473	75473	76473
0,056							70563	71563	72563	74563	75563	76563
0,068	3,5	12,5	7,5			0,3	70683	71683	72683	74683	75683	76683
0,082							70823	71823	72823	74823	75823	76823
0,1							71104	71104	72104	74104	75104	76104
0,12				1,7	5,08		70124	71124	72124	74124	75124	76124
0,15	4	13		\pm	\pm		70154	71154	72154	74154	75154	76154
0,18	4,5	13,5		0,3	0,3	0,3	70184	71184	72184	74184	75184	76184
0,22	4,5	13,5					70224	71224	72224	74224	75224	76224
0,27	5	14	7,5				70274	71274	72274	74274	75274	76274
0,33	5,5	14,5				0,4	70334	71334	72334	74334	75334	76334
0,39	5,5	14,5					70394	71394	72394	74394	75394	76394
0,47	6	15,5					70474	71474	72474	74474	75474	76474
0,56	5,5	14					70564	71564	72564	74564	75564	76564
0,68	5,5	14,5					70684	71684	72684	74684	75684	76684
0,82	6	15					70824	71824	72824	74824	75824	76824
1	6,5	15,5				0,5	70105	71105	72105	74105	75105	76105

$\pm 5\%$ available on request

Metallized polyethyleneterephthalate film capacitors

2222 365/366/367/368/369

Table 8 $U_{Rdc} = 63V$; max. a.c. voltage = 40V, Fig. 2

capacitance μF	b_{max}	h_{max}	l_{max}	A	P	mass g	catalogue number 2222 366											
							loose in box											
							$l_t = 17 \pm 4$			$l_t = 4 \pm 1,0 -0,5$								
C-tol $\pm 20\%$	C-tol $\pm 10\%$	C-tol $\pm 5\%$	C-tol $\pm 20\%$	C-tol $\pm 10\%$	C-tol $\pm 5\%$													
0,12						0,4	10124	11124	12124	14124	15124	16124						
0,15							10154	11154	12154	14154	15154	16154						
0,18	4	12	10	2,0	7,62		10184	11184	12184	14184	15184	16184						
0,22				+	+		10224	11224	12224	14224	15224	16224						
0,27	4,5	13		0,5	0,3	0,5	10274	11274	12274	14274	15274	16274						
0,33	5	13,5					10334	11334	12334	14334	15334	16334						
0,39	5	13,5	10,5			0,6	10394	11394	12394	14394	15394	16394						
0,47	5,5	14					10474	11474	12474	14474	15474	16474						
0,56	5,5	14,5					10564	11564	12564	14564	15564	16564						
0,68	5,5	14,5				0,7	10684	11684	12684	14684	15684	16684						
0,82	5,5	14,5					10824	11824	12824	14824	15824	16824						
1	5,5	14,5					10105	11105	12105	14105	15105	16105						

Table 9 $U_{Rdc} = 100V$; max. a.c. voltage = 63V, Fig. 2

capacitance μF	b_{max}	h_{max}	l_{max}	A	P	mass g	catalogue number 2222 366											
							loose in box											
							$l_t = 17 \pm 4$			$l_t = 4 \pm 1,0 -0,5$								
C-tol $\pm 20\%$	C-tol $\pm 10\%$	C-tol $\pm 5\%$	C-tol $\pm 20\%$	C-tol $\pm 10\%$	C-tol $\pm 5\%$													
0,01							80103	81103	82103	84103	85103	86103						
0,012							80123	81123	82123	84123	85123	86123						
0,015							80153	81153	82153	84153	85153	86153						
0,018							80183	81183	82183	84183	85183	86183						
0,022	3,5	12,5	7,5			0,3	80223	81223	82223	84223	85223	86223						
0,027				1,7	5,08		80273	81273	82273	84273	85273	86273						
0,033				+	+		80333	81333	82333	84333	85333	86333						
0,039				0,3	0,3		80393	81393	82393	84393	85393	86393						
0,047	3,5	12,5					80473	81473	82473	84473	85473	86473						
0,056	3,5	12,5					80563	81563	82563	84563	85563	86563						
0,068	3,5	12,5	7,5				80683	81683	82683	84683	85683	86683						
0,082	4	13					80823	81823	82823	84823	85823	86823						
0,10	4,5	13,5				0,4	80104	81104	82104	84104	85104	86104						

± 5% available on request

Metallized polyethyleneterephthalate film capacitors

2222 365/366/367/368/369

Table 10 $U_{Rdc} = 100V$; max. a.c. voltage = 63V, Fig. 2

capacitance μF	b_max	h_max	l_max	A	P	mass g	catalogue number 2222 366					
							loose in box					
							$l_t = 17 + 4$			$l_t = 4 + 1,0 - 0,5$		
							C-tol + 20%	C-tol + 10%	C-tol + 5%	C-tol + 20%	C-tol + 10%	C-tol + 5%
0,039							20393	21393	22393	24393	25393	26393
0,047							20473	21473	22473	24473	25473	26473
0,056						0,4	20563	21563	22563	24563	25563	26563
0,068	4	12	10				20683	21683	22683	24683	25683	26683
0,082				2,0	7,62		20823	21823	22823	24823	25823	26823
0,10		13		+	+		20104	21104	22104	24104	25104	26104
0,12	4,5	13		0,5	0,3	0,5	20124	21124	22124	24124	25124	26124
0,15	5	13				0,5	20154	21154	22154	24154	25154	26154
0,18	5	13,5	10,5			0,6	20184	21184	22184	24184	25184	26184
0,22	5,5	13,5					20224	21224	22224	24224	25224	26224
0,27	6	14,5				0,7	20274	21274	22274	24274	25274	26274
0,33	6	15					20334	21334	22334	24334	25334	26334
0,39	6	15					20394	21394	22394	24394	25394	26394
0,47	6	15					20474	21474	22474	24474	25474	26474

Table 11 $U_{Rdc} = 250V$; max. a.c. voltage = 160V, Fig. 2

capacitance μF	b_max	h_max	l_max	A	P	mass g	catalogue number 2222 366					
							loose in box					
							$l_t = 17 + 4$			$l_t = 4 + 1,0 - 0,5$		
							C-tol + 20%	C-tol + 10%	C-tol + 5%	C-tol + 20%	C-tol + 10%	C-tol + 5%
0,018							40183	41183	42183	44183	45183	46183
0,022				2,0	7,62	0,4	40223	41223	42223	44223	45223	46223
0,027	4	13	10	+	+		40273	41273	42273	44273	45273	46273
0,033				0,5	0,3		40333	41333	42333	44333	45333	46333
0,039							40393	41393	42393	44393	45393	46393
0,047							40473	41473	42473	44473	45473	46473

**Metallized polyethyleneterephthalate
film capacitors**

2222 365/366/367/368/369

Table 12 U_{Rdc} = 400V; max. a.c. voltage = 220V, Fig. 3

capacitance μF	b _{max}	h _{max}	l _{max}	A	P	mass g	catalogue number 2222 366											
							loose in box											
							l _t = 17 + 4			l _t = 4 +1,0 -0,5								
C-tol + 20%	C-tol + 10%	C-tol + 5%	C-tol + 20%	C-tol + 10%	C-tol + 5%													
0,0033							50332	51332	52332	54332	55332	56332						
0,0039		12					50392	51392	52392	54392	55392	56392						
0,0047							50472	51472	52472	54472	55472	56472						
0,0056							50562	51562	52562	54562	55562	56562						
0,0068							50682	51682	52682	54682	55682	56682						
0,0082	4	13	10	2,0	7,62	0,4	50822	51822	52822	54822	55822	56822						
0,010				0,5	0,3		50103	51103	52103	54103	55103	56103						
0,012							50123	51123	52123	54123	55123	56123						
0,015							50153	51153	52153	54153	55153	56153						

Metallized polyethyleneterephthalate film capacitors

2222 365/366/367/368/369

Dimensions in mm

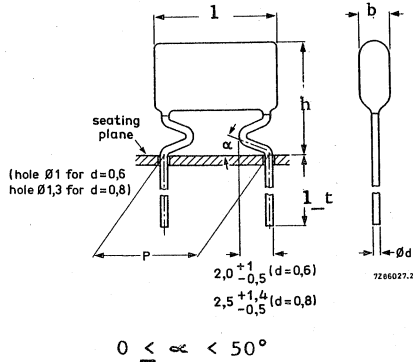

Fig. 3

Terminal pitch P	lead length l	
	short leads	long leads
10,16 15,24	4 +1,0 -0,5	19 + 4
22,86		25 + 4
27,94		24 + 4

Table 13 U_{Rdc} = 63V; max. a.c. voltage = 40 V

capacitance μF	b max	h max	l max	d	t	P	mass g	catalogue number 2222 368								
								loose in box Fig. 3						taped on reel		
								short leads			long leads			Fig. 3 and 7		
								C-tol + 20%	C-tol + 10%	C-tol + 5%	C-tol + 20%	C-tol + 10%	C-tol + 5%	C-tol + 20%	C-tol + 10%	C-tol + 5%
0,22	4,5	12,5	12,5					14224	15224	16224	10224	11224	12224	17224	18224	19224
0,27	4,5	12,5	12,5				0,4	14274	15274	16274	10274	11274	12274	17274	18274	19274
0,33	4,5	12,5	12,5					14334	15334	16334	10334	11334	12334	17334	18334	19334
0,39	4,5	12,5	12,5	0,6		10,16		14394	15394	16394	10394	11394	12394	17394	18394	19394
0,47	5	13	12,5	+0,06		+0,3	0,5	14474	15474	16474	10474	11474	12474	17474	18474	19474
0,56	5	13	12,5	-0,05				14564	15564	16564	10564	11564	12564	17564	18564	19564
0,68	5,5	13,5	12,5					14684	15684	16684	10684	11684	12684	17684	18684	19684
0,82	6	14	12,5				0,6	14824	15824	16824	10824	11824	12824	17824	18824	19824
1,0	6,5	14,5	12,5				0,7	14105	15105	16105	10105	11105	12105	17105	18105	19105

+ 5% available on request

**Metallized polyethyleneterephthalate
film capacitors**

2222 365/366/367/368/369

Table 14 U_{Rdc} = 100V; max. a.c. voltage = 63 V

capaci- tance	b max	h max	l max	d _t	P	mass	catalogue number 2222 368													
							loose in box Fig. 3						taped on reel							
							short leads			long leads			Fig. 3 - 7 - 8							
							C-tol + 20%	C-tol + 10%	C-tol + 5%	C-tol + 20%	C-tol + 10%	C-tol + 5%	C-tol + 20%	C-tol + 10%	C-tol + 5%					
μF						g														
0,056	4	12	12,5				24563	25563	26563	20563	21563	22563	27563	28563	29563					
0,068	4	12	12,5				24683	25683	26683	20683	21683	22683	27683	28683	28683					
0,082	4	12	12,5	0,6	10,16	0,4	24823	25823	26823	20823	21823	22823	27823	28823	29823					
0,10	4	12	12,5	+0,06	+0,3		24104	25104	26104	20104	21104	22104	27104	28104	29104					
0,12	4	12	12,5	-0,05			24124	25124	26124	20124	21124	22124	27124	28124	29124					
0,15	4	12	12,5				24154	25154	26154	20154	21154	22154	27154	28154	29154					
0,18	4,5	12,5	12,5				24184	25184	26184	20184	21184	22184	27184	28184	29184					
0,22	5	13	12,5			0,5	24224	25224	26224	20224	21224	22224	27224	28224	29224					
0,27	5	14	17,5			0,5		25274	26274		21274	22274		28274	29274					
0,33	5	14	17,5			0,6		25334	26334		21334	22334		28334	29334					
0,39	5	14	17,5			0,6		25394	26394		21394	22394		28394	29394					
0,47	5,5	14,5	17,5			0,7		25474	26474		21474	22474		28474	29474					
0,56	5,5	14,5	17,5			0,8		25564	26564		21564	22564		28564	29564					
0,68	6	15	17,5	0,8		1		25684	26684		21684	22684		28684	29684					
0,82	6,5	15,5	17,5	+0,08		1,1		25824	26824		21824	22824		28824	29824					
1,0	7,5	16,5	17,5	-0,05		1,3		25105	26105		21105	22105		28105	29105					
1,2	6	18	26			1,8		25125	26125		21125	22125		28125	29125					
1,5	6	18	26			2,286		25155	26155		21155	22155		28155	29155					
1,8	6	18	26			+0,3	2,3	25185	26185		21185	22185		28185	29185					
2,2	6,5	19,5	26			2,8		25225	26225		21225	22225		28225	29225					
2,7	7,5	20	26			3,2		25275	26275		21275	22275		28275	29275					
3,3	8,5	21	26			4		25335	26335		21335	22335		28335	29335					
3,9	8,5	20,5	30			27,94	4,5	25395	26395		21395	22395		28395	29395					
4,7	9,5	21,5	30			+0,3	5,2	25475	26475		21475	22475		28475	29475					
5,6	10,5	22,5	30			6		25565	26565		21565	22565		28565	29565					
6,8	11,5	23,5	30			6,5		25685	26685		21685	22685		28685	29685					

± 5% available on request

Metallized polyethyleneterephthalate film capacitors

2222 365/366/367/368/369

Table 15 $U_{Rdc} = 250V$; max. a.c. voltage = 160 V

capacitance μF	b max	h max	l max	d t	P	mass g	catalogue number 2222 368									
							loose in box Fig. 3						taped on reel			
							short leads			long leads			Fig. 3 - 7 - 8			
							C-tol + 20%	C-tol + 10%	C-tol + 5%	C-tol + 20%	C-tol + 10%	C-tol + 5%	C-tol + 20%	C-tol + 10%	C-tol + 5%	
0,027	4	12	12,5				44273	45273	46273	40273	41273	42273	47273	48273	49273	
0,033	4	12	12,5				44333	45333	46333	40333	41333	42333	47333	48333	49333	
0,039	4	12	12,5			10,16	44393	45393	46393	40393	41393	42393	47393	48393	49393	
0,047	4	12	12,5			+0,3	0,4	44473	45473	46473	40473	41473	42473	47473	48473	49473
0,056	4,5	12,5	12,5			0,6		44563	45563	46563	40563	41563	42563	47563	48563	49563
0,068	4,5	12,5	12,5			+0,06		44683	45683	46683	40683	41683	42683	47683	48683	49683
0,082	5	13	12,5			-0,05	0,5	44823	45823	46823	40823	41823	42823	47823	48823	49823
0,10	5	13	12,5					44104	45104	46104	40104	41104	42104	47104	48104	49104
0,12	5	14	17,5			0,6			45124	46124		41124	42124		48124	49124
0,15	5	14	17,5			15,24	0,7		45154	46154		41154	42154		48154	49154
0,18	5,5	14,5	17,5			+0,3	0,8		45184	46184		41184	42184		48184	49184
0,22	6	15	17,5				0,9		45224	46224		41224	42224		48224	49224
0,27	6,5	15,5	17,5				1,1		45274	46274		41274	42274		48274	49274
0,33	7	16	17,5				1,3		45334	46334		41334	42334		48334	49334
0,39	5	17	26				1,8		45394	46394		41394	42394		48394	49394
0,47	5,5	17,5	26				2,1		45474	46474		41474	42474		48474	49474
0,56	6	18	26			22,86	2,5		45564	46564		41564	42564		48564	49564
0,68	6,5	18,5	26			0,8	+0,3	2,9	45684	46684		41684	42684		48684	49684
0,82	7	19	26			+0,08		3,3	45824	46824		41824	42824		48824	49824
1,0	7,5	19,5	26			-0,05		3,6	45105	46105		41105	42105		48105	49105
1,2	7,5	19,5	30					4	45125	46125		41125	42125		48125	49125
1,5	8,5	20,5	30			27,94	5,1		45155	46155		41155	42155		48155	49155
1,8	9,5	21,5	30			+0,3	5,9		45185	46185		41185	42185		48185	49185
2,2	10,5	22,5	30				6,4		45225	46225		41225	42225		48225	49225

+ 5% available on request

Metallized polyethyleneterephthalate film capacitors

2222 365/366/367/368/369

Table 16 $U_{Rdc} = 400V$; max. a.c. voltage = 220 V

capacitance μF	b_{max}	h_{max}	l_{max}	d	t	P	mass g	catalogue number 2222 368								
								loose in box Fig. 3						taped on reel		
								short leads			long leads			Fig. 3 - 7 - 8		
								C-tol + 20%	C-tol + 10%	C-tol + 5%	C-tol + 20%	C-tol + 10%	C-tol + 5%	C-tol + 20%	C-tol + 10%	C-tol + 5%
0,001	4	12	12,5					54102	55102	56102	50102	51102	52102	57102	58102	59102
0,0012	4	12	12,5					54122	55122	56122	50122	51122	52122	57122	58122	59122
0,0015	4	12	12,5					54152	55152	56152	50152	51152	52152	57152	58152	59152
0,0018	4	12	12,5					54182	55182	56182	50182	51182	52182	57182	58182	59182
0,0022	4	12	12,5					54222	55222	56222	50222	51222	52222	57222	58222	59222
0,0027	4	12	12,5					54272	55272	56272	50272	51272	52272	57272	58272	59272
0,0033	4	12	12,5	0,6		10,16		54332	55332	56332	50332	51332	52332	57332	58332	59332
0,0039	4	12	12,5	+0,06		+0,3		54392	55392	56392	50392	51392	52392	57392	58392	59392
0,0047	4	12	12,5	-0,05				54472	55472	56472	50472	51472	52472	57472	58472	59472
0,0056	4	12	12,5					54562	55562	56562	50562	51562	52562	57562	58562	59562
0,0068	4	12	12,5				0,4	54682	55682	56682	50682	51682	52682	57682	58682	59682
0,0082	4	12	12,5					54822	55822	56822	50822	51822	52822	57822	58822	59822
0,010	4	12	12,5					54103	55103	56103	50103	51103	52103	57103	58103	59103
0,012	4	12	12,5					54123	55123	56123	50123	51123	52123	57123	58123	59123
0,015	4	12	12,5					54153	55153	56153	50153	51153	52153	57153	58153	59153
0,018	4	12	12,5					54183	55183	56183	50183	51183	52183	57183	58183	59183
0,022	4	12	12,5					54223	55223	56223	50223	51223	52223	57223	58223	59223
0,027	4,5	12,5	12,5					54273	55273	56273	50273	51273	52273	57273	58273	59273
0,033	4,5	12,5	12,5					54333	55333	56333	50333	51333	52333	57333	58333	59333
0,039	5	14	17,5				0,6	55393	56393			51393	52393		58393	59393
0,047	5	14	17,5			15,24	0,6	55473	56473			51473	52473		58473	59473
0,056	5	14	17,5			+0,3	0,6	55563	56563			51563	52563		58563	59563
0,068	5	14	17,5				0,7	55683	56683			51683	52683		58683	59683
0,082	5,5	14,5	17,5				0,8	55823	56823			51823	52823		58823	59823
0,10	6	15	17,5				0,9	55104	56104			51104	52104		58104	59104
0,12	6,5	15,5	17,5				1,1	55124	56124			51124	52124		58124	59124
0,15	7	16	17,5				1,3	55154	56154			51154	52154		58154	59154
0,18	5,5	17,5	26	0,8			1,6	55184	56184			51184	52184		58184	59184
0,22	6	18	26	+0,08		22,86	1,9	55224	56224			51224	52224		58224	59224
0,27	6,5	18,5	26	-0,05		+0,3	2,3	55274	56274			51274	52274		58274	59274
0,33	6,5	19	26				2,6	55334	56334			51334	52334		58334	59334
0,39	7	19,5	26				3	55394	56394			51394	52394		58394	59394
0,47	8	20,5	26				3,4	55474	56474			51474	52474		58474	59474
0,56	8	20	30				3,5	55564	56564			51564	52564		58564	59564
0,68	8,5	20,5	30			27,94	4	55684	56684			51684	52684		58684	59684
0,82	9,5	21,5	30			+0,3	4,5	55824	56824			51824	52824		58824	59824
1	11	23	30				5,0	55105	56105			51105	52105		58105	59105

± 5% available on request

**Metallized polyethyleneterephthalate
film capacitors**

2222 365/366/367/368/369

Table 17 U_{Rdc} = 630V; max. a.c. voltage = 220 V

capacitance μF	b _{max}	h _{max}	l _{max}	d _t	P	mass g	catalogue number 2222 368								
							loose in box Fig. 3						taped on reel		
							short leads			long leads			Fig. 3 - 7 - 8		
							C-tol + 20%	C-tol + 10%	C-tol + 5%	C-tol + 20%	C-tol + 10%	C-tol + 5%	C-tol + 20%	C-tol + 10%	C-tol + 5%
0,01	4,5	12,5	12,5			0,4	64103	65103	66103	60103	61103	62103	67103	68103	69103
0,012	5	13	12,5			0,5	64123	65123	66123	60123	61123	62123	67123	68123	69123
0,015	5,5	13,5	12,5	+0,06		0,5	64153	65153	66153	60153	61153	62153	67153	68153	69153
0,018	6	14	12,5	-0,05		0,6	64183	65183	66183	60183	61183	62183	67183	68183	69183
0,022	6,5	14,5	12,5			0,7	64223	65223	66223	60223	61223	62223	67223	68223	69223
0,027	5,5	14,5	17,5			0,9		65273	66273		61273	62273		68273	69273
0,033	6	15	17,5			1		65333	66333		61333	62333		68333	69333
0,039	6,5	15,5	17,5		15,24	1,1		65393	66393		61393	62393		68393	69393
0,047	7	16	17,5			1,2		65473	66473		61473	62473		68473	69473
0,056	7,5	16,5	17,5			1,3		65563	66563		61563	62563		68563	69563
0,068	8	17	17,5			1,4		65683	66683		61683	62683		68683	69683
0,082	5,5	17,5	26			1,8		65823	66823		61823	62823		68823	69823
0,1	6	18	26			2,1		65104	66104		61104	62104		68104	69104
0,12	7	19	26		22,86	2,5		65124	66124		61124	62124		68124	69124
0,15	7,5	19,5	26	0,8		2,9		65154	66154		61154	62154		68154	69154
0,18	8,5	20,5	26	+0,08		3,2		65184	66184		61184	62184		68184	69184
0,22	9,5	21,5	26	-0,05		3,5		65224	66224		61224	62224		68224	69224
0,27	9	21	30			4,3		65274	66274		61274	62274		68274	69274
0,33	10	22	30		27,94	5		65334	66334		61334	62334		68334	69334
0,39	11	23	30			5,6		65394	66394		61394	62394		68394	69394
0,47	12	24	30			6,5		65474	66474		61474	62474		68474	69474

+5% available on request

Metallized polyethyleneterephthalate film capacitors

2222 365/366/367/368/369

Dimensions in mm

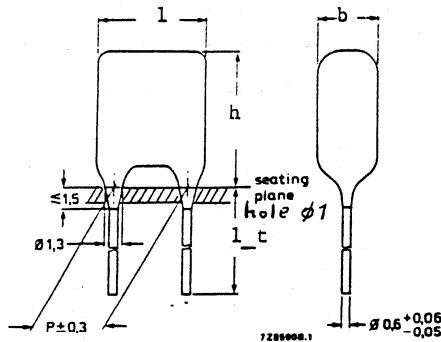

Fig. 4

Table 18 $U_{Rdc} = 63V$; max. a.c. voltage = 40 V, Fig. 4

capacitance	b_{max}	h_{max}	l_{max}	P	mass	catalogue number 2222 367					
						loose in box					
						$l_t = 22 \pm 4$			$l_t = 4 +1,0 -0,5$		
μF					g	C-tol $\pm 20\%$	C-tol $\pm 10\%$	C-tol $\pm 5\%$	C-tol $\pm 20\%$	C-tol $\pm 10\%$	C-tol $\pm 5\%$
0,047						70473	71473	72473	74473	75473	76473
0,056						70563	71563	72563	74563	75563	76563
0,068	3,5	7,5	7,5		0,3	70683	71683	72683	74683	75683	76683
0,082						70823	71823	72823	74823	75823	76823
0,1						70104	71104	72104	74104	75104	76104
0,12				5,08		70124	71124	72124	74124	75124	76124
0,15	4	8		$+0,3$		70154	71154	72154	74154	75154	76154
0,18	4,5	8,5			0,3	70184	71184	72184	74184	75184	76184
0,22	4,5	8,5				70224	71224	72224	74224	75224	76224
0,27	5	9	7,5			70274	71274	72274	74274	75274	76274
0,33	5,5	9,5			0,4	70334	71334	72334	74334	75334	76334
0,39	5,5	10,5				70394	71394	72394	74394	75394	76394
0,47	6	11,5				70474	71474	72474	74474	75474	76474
0,56	5,5	10				70564	71564	72564	74564	75564	76564
0,68	5,5	10,5				70684	71684	72684	74684	75684	76684
0,82	6	11				70824	71824	72824	74824	75824	76824
1	6,5	11,5			0,5	70105	71105	72105	74105	75105	76105

+ 5% available on request

Metallized polyethyleneterephthalate film capacitors

2222 365/366/367/368/369

Table 19 $U_{Rdc} = 63V$; max. a.c. voltage = 40V, Fig. 4

capacitance μF	b_max	h_max	l_max	P	mass g	catalogue number 2222 367					
						loose in box					
						$l_t = 22 \pm 4$			$l_t = 4 +1,0 -0,5$		
C-tol $\pm 20\%$	C-tol $\pm 10\%$	C-tol $\pm 5\%$	C-tol $\pm 20\%$	C-tol $\pm 10\%$	C-tol $\pm 5\%$						
0,12	4	8	10	7,62 +0,3	0,4	10124	11124	12124	14124	15124	16124
0,15						10154	11154	12154	14154	15154	16154
0,18						10184	11184	12184	14184	15184	16184
0,22	4,5	8,5	10,5	7,62 +0,3	0,5	10224	11224	12224	14224	15224	16224
0,27						10274	11274	12274	14274	15274	16274
0,33						10334	11334	12334	14334	15334	16334
0,39	5	9	10,5	7,62 +0,3	0,6	10394	11394	12394	14394	15394	16394
0,47	5,5	9,5				10474	11474	12474	14474	15474	16474
0,56	5,5	10				10564	11564	12564	14564	15564	16564
0,68	5,5	10	10,5	7,62 +0,3	0,7	10684	11684	12684	14684	15684	16684
0,82	5,5	10				10824	11824	12824	14824	15824	16824
1	5,5	10				10105	11105	12105	14105	15105	16105

Table 20 $U_{Rdc} = 100V$; max. a.c. voltage = 63V, Fig. 4

capacitance μF	b_max	h_max	l_max	P	mass g	catalogue number 2222 367					
						loose in box					
						$l_t = 22 \pm 4$			$l_t = 4 +1,0 -0,5$		
C-tol $\pm 20\%$	C-tol $\pm 10\%$	C-tol $\pm 5\%$	C-tol $\pm 20\%$	C-tol $\pm 10\%$	C-tol $\pm 5\%$						
0,01	3,5	7,5	7,5	5,08 +0,3	0,3	80103	81103	82103	84103	85103	86103
0,012						80123	81123	82123	84123	85123	86123
0,015						80153	81153	82153	84153	85153	86153
0,018	3,5	7,5	7,5	5,08 +0,3	0,3	80183	81183	82183	84183	85183	86183
0,022						80223	81223	82223	84223	85223	86223
0,027						80273	81273	82273	84273	85273	86273
0,033	3,5	7,5	7,5	5,08 +0,3	0,3	80333	81333	82333	84333	85333	86333
0,039						80393	81393	82393	84393	85393	86393
0,047						80473	81473	82473	84473	85473	86473
0,056	3,5	7,5	7,5	5,08 +0,3	0,3	80563	81563	82563	84563	85563	86563
0,068	3,5	7,5	80683			81683	82683	84683	85683	86683	
0,082	4	8	80823			81823	82823	84823	85823	86823	
0,10	4,5	8,5	10,5	7,62 +0,3	0,4	80104	81104	82104	84104	85104	86104

+ 5% available on request

**Metallized polyethyleneterephthalate
film capacitors**
2222 365/366/367/368/369
Table 21 $U_{Rdc} = 100V$; max. a.c. voltage = 63V, Fig. 4

capaci- tance	b_max	h_max	l_max	P	mass	catalogue number 2222 367					
						loose in box					
						l_t = 22 + 4			l_t = 4 +1,0 -0,5		
						μF					
0,039	4	8				20393	21393	22393	24393	25393	26393
0,047	4	8				20473	21473	22473	24473	25473	26473
0,056	4	8	10		0,4	20563	21563	22563	24563	25563	26563
0,068	4	8				20683	21683	22683	24683	25683	26683
0,082	4	8		7,62		20823	21823	22823	24823	25823	26823
0,10	4	8,5		+0,3		20104	21104	22104	24104	25104	26104
0,12	4,5	9			0,5	20124	21124	22124	24124	25124	26124
0,15	5	9,5			0,5	20154	21154	22154	24154	25154	26154
0,18	5	9,5	10,5		0,6	20184	21184	22184	24184	25184	26184
0,22	5,5	10				20224	21224	22224	24224	25224	26224
0,27	6	10,5			0,7	20274	21274	22274	24274	25274	26274
0,33	6	10,5				20334	21334	22334	24334	25334	26334
0,39	6	10,5				20394	21394	22394	24394	25394	26394
0,47	6	10,5				20474	21474	22474	24474	25474	26474

Table 22 $U_{Rdc} = 250V$; max. a.c. voltage = 160V, Fig. 4

capaci- tance	b_max	h_max	l_max	P	mass	catalogue number 2222 367					
						loose in box					
						l_t = 22 + 4			l_t = 4 +1,0 -0,5		
						μF					
0,018						40183	41183	42183	44183	45183	46183
0,022				7,62		40223	41223	42223	44223	45223	46223
0,027	4	8,5	10	+0,3	0,4	40273	41273	42273	44273	45273	46273
0,033						40333	41333	42333	44333	45333	46333
0,039						40393	41393	42393	44393	45393	46393
0,047						40473	41473	42473	44473	45473	46473

**Metallized polyethyleneterephthalate
film capacitors**

2222 365/366/367/368/369

Table 23 U_R (d.c.) = 400V; max. a.c. voltage = 220V, Fig. 5

capaci- tance	b_max	h_max	l_max	P	mass	catalogue number 2222 367					
						loose in box					
						l_t = 22 + 4			l_t = 4 +1,0 -0,5		
						C-tol + 20%	C-tol + 10%	C-tol + 5%	C-tol + 20%	C-tol + 10%	C-tol + 5%
μF					g						
0,0033						50332	51332	52332	54332	55332	56332
0,0039						50392	51392	52392	54392	55392	56392
0,0047						50472	51472	52472	54472	55472	56472
0,0056				7,62		50562	51562	52562	54562	55562	56562
0,0068				+0,3	0,4	50682	51682	52682	54682	55682	56682
0,0082	4	8,5	10			50822	51822	52822	54822	55822	56822
0,010						50103	51103	52103	54103	55103	56103
0,012						50123	51123	52123	54123	55123	56123
0,015						50153	51153	52153	54153	55153	56153

Metallized polyethyleneterephthalate film capacitors

2222 365/366/367/368/369

All dimensions are given in mm.

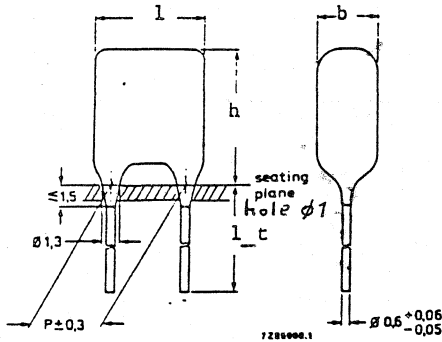

Fig. 5

Terminal Pitch P	lead length l	
	short leads	4 +1,0 -0,5
10,16	long leads	22 ± 4

Table 24 $U_{Rdc} = 63V$; max. a.c. voltage = 40 V

capacitance μF	b_{max}	h_{max}	l_{max}	d	t	P	mass g	catalogue number 2222 369								
								loose in box Fig. 5						taped on reel		
								short leads			long leads			Fig. 5 and 9		
								C-tol + 20%	C-tol + 10%	C-tol + 5%	C-tol + 20%	C-tol + 10%	C-tol + 5%	C-tol + 20%	C-tol + 10%	C-tol + 5%
0,22	4,5	10	12,5					14224	15224	16224	10224	11224	12224	17224	18224	19224
0,27	4,5	10	12,5					14274	15274	16274	10274	11274	12274	17274	18274	19274
0,33	4,5	10	12,5				0,4	14334	15334	16334	10334	11334	12334	17334	18334	19334
0,39	4,5	10	12,5	0,6		10,16		14394	15394	16394	10394	11394	12394	17394	18394	19394
0,47	5	10,5	12,5	+0,06		+ 0,3	0,5	14474	15474	16474	10474	11474	12474	17474	18474	19474
0,56	5	10,5	12,5	-0,05				14564	15564	16564	10564	11564	12564	17564	18564	19564
0,68	5,5	11	12,5				0,5	14684	15684	16684	10684	11684	12684	17684	18684	19684
0,82	6	11,5	12,5				0,6	14824	15824	16824	10824	11824	12824	17824	18824	19824
1	6,5	12	12,5				0,7	14105	15105	16105	10105	11105	12105	17105	18105	19105

± 5% available on request

Metallized polyethyleneterephthalate film capacitors

2222 365/366/367/368/369

Table 25 $U_{Rdc} = 100V$; max. a.c. voltage = 63 V

capacitance	b max	h max	l max	d_t	P	mass	catalogue number 2222 369													
							loose in box Fig. 5						taped on reel							
							short leads			long leads			Fig. 5 and 9							
							C-tol + 20%	C-tol + 10%	C-tol + 5%	C-tol + 20%	C-tol + 10%	C-tol + 5%	C-tol + 20%	C-tol + 10%	C-tol + 5%					
μF						g														
0,056	4	9,5	12,5				24563	25563	26563	20563	21563	22563	27563	28563	29563					
0,068	4	9,5	12,5				24683	25683	26683	20683	21683	22683	27683	28683	29683					
0,082	4	9,5	12,5			0,4	24823	25823	26823	20823	21823	22823	27823	28823	29823					
0,10	4	9,5	12,5		10,16		24104	25104	26104	20104	21104	22104	27104	28104	29104					
0,12	4	9,5	12,5	+0,06	+0,3		24124	25124	26124	20124	21124	22124	27124	28124	29124					
0,15	4	9,5	12,5	-0,05			24154	25154	26154	20154	21154	22154	27154	28154	29154					
0,18	4,5	10	12,5			0,5	24184	25184	26184	20184	21184	22184	27184	28184	29184					
0,22	5	10,5	12,5			0,5	24224	25224	26224	20224	21224	22224	27224	28224	29224					

Table 26 $U_{Rdc} = 250V$; max. a.c. voltage = 160 V

capacitance	b max	h max	l max	d_t	P	mass	catalogue number 2222 369													
							loose in box Fig. 5						taped on reel							
							short leads			long leads			Fig. 5 and 9							
							C-tol + 20%	C-tol + 10%	C-tol + 5%	C-tol + 20%	C-tol + 10%	C-tol + 5%	C-tol + 20%	C-tol + 10%	C-tol + 5%					
μF						g														
0,027	4	9,5	12,5				44273	45273	46273	40273	41273	42273	47273	48273	49273					
0,033	4	9,5	12,5				44333	45333	46333	40333	41333	42333	47333	48333	49333					
0,039	4	9,5	12,5		10,16		44393	45393	46393	40393	41393	42393	47393	48393	49393					
0,047	4	9,5	12,5		+0,3	0,4	44473	45473	46473	40473	41473	42473	47473	48473	49473					
0,056	4,5	10	12,5		0,6		44563	45563	46563	40563	41563	42563	47563	48563	49563					
0,068	4,5	10	12,5	+0,06			44683	45683	46683	40683	41683	42683	47683	48683	49683					
0,082	5	10,5	12,5	-0,05		0,5	44823	45823	46823	40823	41823	42823	47823	48823	49823					
0,10	5	10,5	12,5				44104	45104	46104	40104	41104	42104	47104	48104	49104					

± 5% available on request

**Metallized polyethyleneterephthalate
film capacitors**

2222 365/366/367/368/369

Table 27 U_{Rdc} = 400V; max. a.c. voltage = 220 V

capacitance μF	b _{max}	h _{max}	l _{max}	d _t	P	mass g	catalogue number 2222 369								
							loose in box Fig. 5						taped on reel		
							short leads			long leads			Fig. 5 and 9		
							C-tol + 20%	C-tol + 10%	C-tol + 5%	C-tol + 20%	C-tol + 10%	C-tol + 5%	C-tol + 20%	C-tol + 10%	C-tol + 5%
0,001	4	9,5	12,5				54102	55102	56102	50102	51102	52102	57102	58102	59102
0,0012	4	9,5	12,5				54122	55122	56122	50122	51122	52122	57122	58122	59122
0,0015	4	9,5	12,5				54152	55152	56152	50152	51152	52152	57152	58152	59152
0,0018	4	9,5	12,5				54182	55182	56182	50182	51182	52182	57182	58182	59182
0,0022	4	9,5	12,5				54222	55222	56222	50222	51222	52222	57222	58222	59222
0,0027	4	9,5	12,5				54272	55272	56272	50272	51272	52272	57272	58272	59272
0,0033	4	9,5	12,5				54332	55332	56332	50332	51332	52332	57332	58332	59332
0,0039	4	9,5	12,5	0,6	10,16		54392	55392	56392	50392	51392	52392	57392	58392	59392
0,0047	4	9,5	12,5	+0,06	+0,3		54472	55472	56472	50472	51472	52472	57472	58472	59472
0,0056	4	9,5	12,5	-0,05		10,4	54562	55562	56562	50562	51562	52562	57562	58562	59562
0,0068	4	9,5	12,5				54682	55682	56682	50682	51682	52682	57682	58682	59682
0,0082	4	9,5	12,5				54822	55822	56822	50822	51822	52822	57822	58822	59822
0,010	4	9,5	12,5				54103	55103	56103	50103	51103	52103	57103	58103	59103
0,012	4	9,5	12,5				54123	55123	56123	50123	51123	52123	57123	58123	59123
0,015	4	9,5	12,5				54153	55153	56153	50153	51153	52153	57153	58153	59153
0,018	4	9,5	12,5				54183	55183	56183	50183	51183	52183	57183	58183	59183
0,022	4	9,5	12,5				54223	55223	56223	50223	51223	52223	57223	58223	59223
0,027	4,5	10	12,5				54273	55273	56273	50273	51273	52273	57273	58273	59273
0,033	4,5	10	12,5				54333	55333	56333	50333	51333	52333	57333	58333	59333

± 5 % available on request

**Metallized polyethyleneterephthalate
film capacitors**

2222 365/366/367/368/369

Table 28 U_{Rdc} = 630V; max. a.c. voltage = 220 V

capa- ci- tance	b max	h max	l max	d _t	P	mass g	catalogue number 2222 369								
							loose in box Fig. 5						taped on reel		
							short leads			long leads			Fig. 5 and 9		
							C-tol + 20%	C-tol + 10%	C-tol + 5%	C-tol + 20%	C-tol + 10%	C-tol + 5%	C-tol + 20%	C-tol + 10%	C-tol + 5%
μF															
0,010	4,5	10	12,5			0,4	64103	65103	66103	60103	61103	62103	67103	68103	69103
0,012	5	10,5	12,5	0,6	10,16	0,5	64123	65123	66123	60123	61123	62123	67123	68123	69123
0,015	5,5	11	12,5	+0,06	+ 0,3	0,5	64153	65153	66153	60153	61153	62153	67153	68153	69153
0,018	6	11,5	12,5	-0,05		0,6	64183	65183	66183	60183	61183	62183	67183	68183	69183
0,022	6,5	12	12,5			0,7	64223	65223	66223	60223	61223	62223	67223	68223	69223

+ 5% available on request

Metallized polyethyleneterephthalate film capacitors

2222 365/366/367/368/369

1.2.2 Packing

The capacitors are supplied loose in box, taped on reel or in ammpack, details of quantities are given in Tables 29 to 32.

Loose in box

Table 29 : Number of capacitors per box.

l_{\max} mm	b_{\max} mm	Number of capacitors per box			
		short leads		long leads	
		SPQ	PQ	SPQ	PQ
7,5	$\leq 5,5$	1000	16000	1000	12000
	6	1000	12000		
10	4	1000	16000	1000	12000
	4,5 or 5	1000	16000	1000	8000
	5,5 or 6	1000	12000		
12,5 or 13		2000	16000	1000	8000
17,5		2000	8000	1000	4000
23,5	6, 6,5 or 7	2000	2000		
	$\geq 7,5$	1000	4000		
26	≤ 7			1000	4000
	$\geq 7,5$	1000	4000	500	2000
30 or 31	$\leq 9,5$	500	2000	500	2000
	$> 9,5$			250	1000
	≥ 12	250	1000		

**Metallized polyethyleneterephthalate
film capacitors**

2222 365/366/367/368/369

Reel and ammunition packing

1. Dimensions of taped products

Style 2222 365

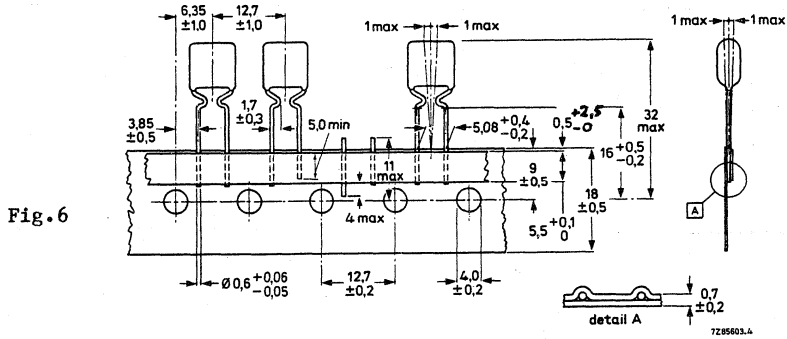

Style 2222 369

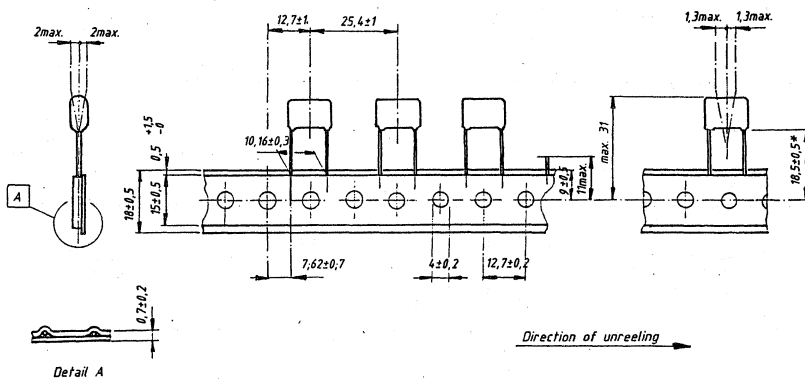

FOR PHYSICAL DIMENSIONS SEE PRODUCT SPECIFICATION

* Distance between seating plane and sprocket hole

Metallized polyethyleneterephthalate film capacitors

2222 365/366/367/368/369

Style 2222 368

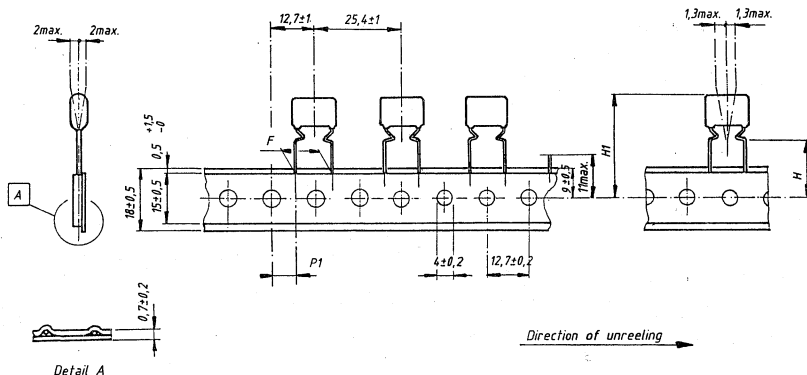

FOR PHYSICAL DIMENSIONS SEE PRODUCT SPECIFICATION

ITEM	SYMBOL	VALUE	VALUE	TOLERANCE
Lead to lead distance	F	10,16	15,24	+0,5 / -0,1
Height of component from tape center to seating plane	H	16,0		±0,5
Component height from tape center	H 1	max 31,0	max 34,0	
Feed hole to lead center	P1	7,62	5,08	±0,7

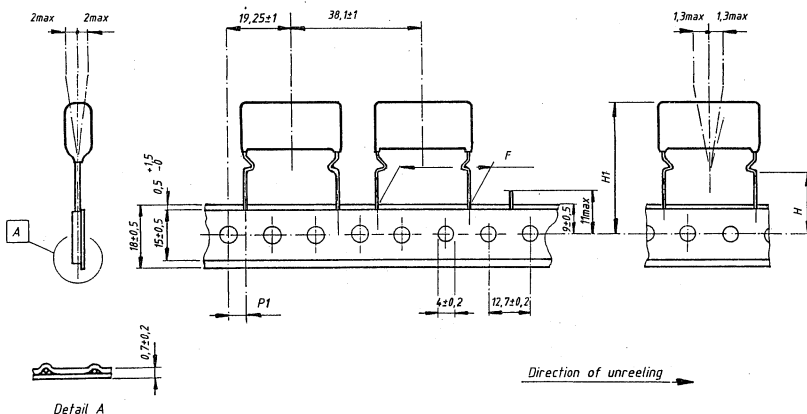

FOR PHYSICAL DIMENSIONS SEE PRODUCT SPECIFICATION

ITEM	SYMBOL	VALUE	VALUE	TOLERANCE
Lead to lead distance	F	22,86	27,94	+0,5 / -0,1
Height of component from tape center to seating plane	H	16,0		±0,5
Component height from tape center	H 1	max 38,0	max 41,0	
Feed hole to lead center	P1	7,8	5,3	±0,7

**Metallized polyethyleneterephthalate
film capacitors**

2222 365/366/367/368/369

2. Characteristics concerning taped products

Pull-out force of the component ≥ 5 N

Pull-off force of the adhesive tape ≥ 6 N

Tearing force of tape ≥ 15 N

Storage conditions :

Storage temperature -25°C to $+40^{\circ}\text{C}$
Relative humidity max. 80% without condensation.

3. Outlines of reel and ammunition packing

Style 2222 365

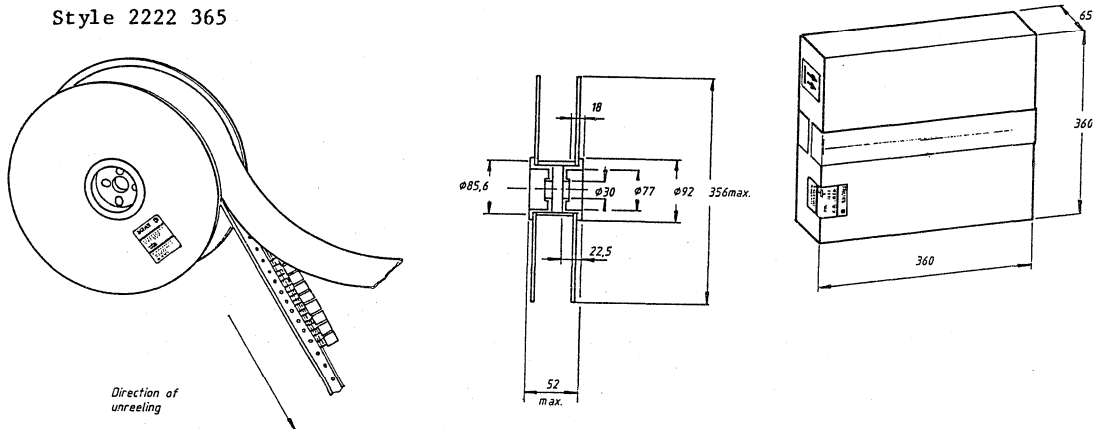
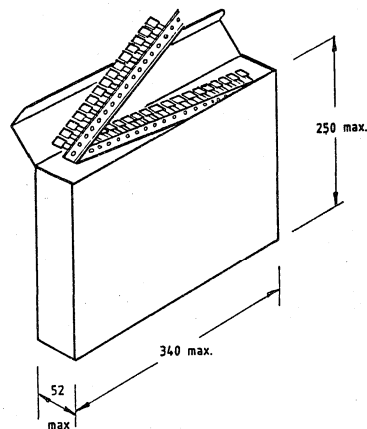

Fig. 10



**Metallized polyethyleneterephthalate
film capacitors**

2222 365/366/367/368/369

Style 2222 368, 2222 369

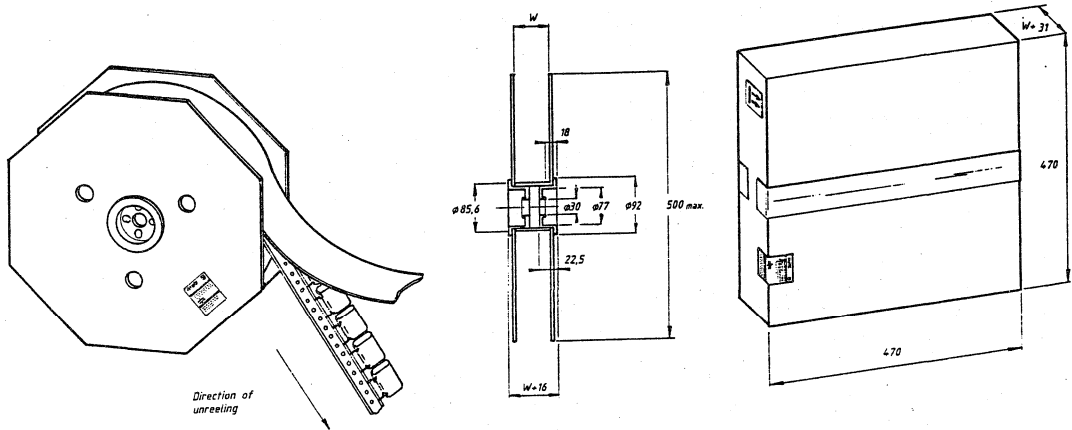

Fig. 11

**Metallized polyethyleneterephthalate
film capacitors**

2222 365/366/367/368/369

4. Number of capacitors per reel and ammpack

Table 30 : l_{max} 7,5 or 10mm

b_{max} mm	number of capacitors per reel	number of capacitors per ammpack
4	1500	1500
$\geq 4,5$	1000	1000

Table 31 : l_{max} 12,5 or 17,5mm

b_{max} mm	number per reel	$l_{max} = 12,5mm$		$l_{max} = 17,5mm$ $W \pm 2mm$
		$W \pm 2mm$ style 2222 368	$W \pm 2mm$ style 2222 369	
4	1500	40	40	
4,5	1300	40	40	
5	1200	40	45	45
5,5	1100	40	45	45
6	1000	45	45	45
6,5	900	45	45	45
7	800			45
7,5	800			45
8	750			45

Table 32 : l_{max} 26 or 30mm

b_{max} mm	number per reel	$W \pm 2mm$
5	800	45
5,5	750	45
6	650	50
6,5	600	50
7	550	50
7,5 - 8	500	50
8,5 - 9	450	50
9,5 - 10	400	50
10,5	350	50
11 - 12	350	55

Cumulative pitch error : 1,0mm/20 pitches.
The max. number of empty places per reel shall not exceed 0,5% of the total number of components per reel, but no more than 2 consecutive positions may be vacant.

**Metallized polyethyleneterephthalate
film capacitors**

2222 365/366/367/368/369

1.3. Ratings and characteristics

Unless otherwise specified all electrical values apply to an ambient free air temperature of $23 \pm 1^\circ\text{C}$, an atmospheric pressure of 86 to 106 kPa and a relative humidity of $50 \pm 2\%$.

1.3.1 Capacitance

Capacitance range at 1 kHz see Tables 1 to 28

Capacitance tolerance see Tables 1 to 28

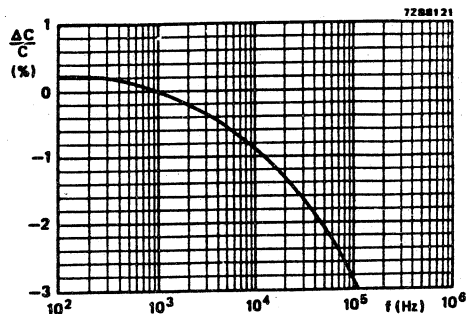

Fig. 12 : Capacitance as a function of frequency; typical curve.

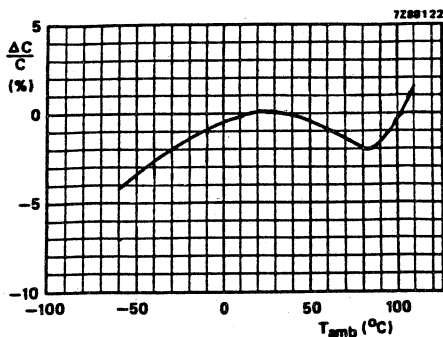

Fig. 13 : Capacitance as a function of ambient free air temperature, measured at 1kHz, 1V; typical curve.

**Metallized polyethyleneterephthalate
film capacitors**

2222 365/366/367/368/369**1.3.2 Voltage**Rated voltage U_{Rdc}

See Tables 1 to 28

Category voltage U_C $0,8 \times U_{Rdc}$

Test voltage

between terminations

 $1,6 \times U_{Rdc}$ between interconnected terminations
and case(foil method) $2 \times U_{Rdc}$; min. 200VMax. a.c. voltage (r.m.s. value),
at 50 to 60 Hz

See Tables 1 to 28

1.3.3 Climatic category

40/100/56

1.3.4 Rated temperature

85°C

1.3.5 Storage temperature range

Temperature -25°C to + 40°C

RH max. 80% without condensation

Metallized polyethyleneterephthalate film capacitors

2222 365/366/367/368/369

1.3.6 Tangent of loss angle

capacitance	tangent of loss angle		
	1 kHz	10 kHz	100 kHz
$C < 0,1\mu\text{F}$	$< 75 \times 10^{-4}$	$< 130 \times 10^{-4}$	$< 225 \times 10^{-4}$
$0,1\mu\text{F} < C < 0,47\mu\text{F}$	$< 75 \times 10^{-4}$	$< 130 \times 10^{-4}$	$< 300 \times 10^{-4}$
$0,47\mu\text{F} < C < 1\mu\text{F}$	$< 75 \times 10^{-4}$	$< 130 \times 10^{-4}$	
$C > 1\mu\text{F}$	$< 75 \times 10^{-4}$	$< 150 \times 10^{-4}$	

Fig. 14 : Tan delta as a function of frequency, typical curve

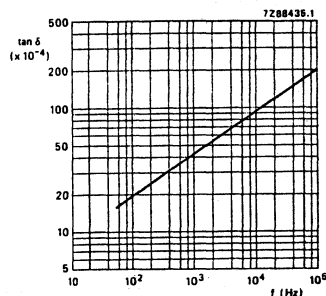

1.3.7 Maximum pulse load

rated voltage V	maximum pulse load (V/μs)					
	l=7,5mm	l=10mm	l=13mm	l=17,5mm	l=26mm	l=31mm
63	110	18	30			
100	110	36	28	20	8	7
250		70	70	28	12	10
400		110	110	44	20	16
630			70	70	28	24

The maximum pulse load values in the table are valid for pulse voltages equal to the rated voltage.

For lower pulse voltages the given values may be multiplied by $U_{Rdc}/\text{applied voltage}$.

**Metallized polyethyleneterephthalate
film capacitors**

2222 365/366/367/368/369

1.3.8 Insulation resistance at $T_{amb} 20^{\circ}C$

The insulation resistance is measured after a voltage has been applied for 1 min. + 5 s., the voltage being 10 + 1V for the 63V version, 100V + 15V for the 100V, 250V and 400V versions and 500 + 50V for the 630V version.

R between terminations, for $C \leq 0,33\mu F$
 63V and 100V versions > 15 000 MΩ
 250V, 400V and 630V versions > 30 000 MΩ

RC between terminations, for $C > 0,33\mu F$
 63V and 100V versions > 5 000 s
 250V, 400V and 630V versions > 10 000 s

R between interconnected terminations and case > 30 000 MΩ
 (foil method)

Fig. 15 : RC-product as a function of ambient free air temperature; typical curve

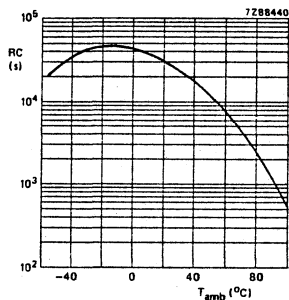

Metallized polyethyleneterephthalate film capacitors

2222 365/366/367/368/369

1.3.9 Maximum dissipation

The power dissipated by a capacitor is a function of the voltage U_{esr} across or the current I through the series resistance ESR and is expressed by:

$$P = \frac{U_{esr}^2}{ESR} \quad (1) \quad \text{or } P = ESR \cdot I^2 \quad (2)$$

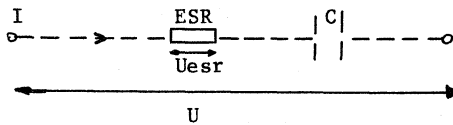

$$U_{esr}^2 = \frac{ESR^2}{ESR^2 + 1/\omega^2 C^2} \cdot U^2 \quad (3a)$$

As for film capacitors $\tan_{\Delta} = \omega \cdot C \cdot ESR \ll 0.1$, the formula (3a) can be simplified to

$$U_{esr}^2 = ESR^2 \cdot \omega^2 \cdot C^2 \cdot U^2 \quad (3b)$$

or with $ESR = \tan_{\Delta} / \omega C$, we become:

$$P = \omega \cdot C \cdot \tan_{\Delta} \cdot U^2 \quad (4) \quad \text{or } P = \frac{\tan_{\Delta}}{\omega \cdot C} I^2 \quad (5)$$

For the \tan_{Δ} we can take the value found from fig.14, C is in farad and $\omega = 2\pi \cdot f$.

U or I are assumed to be known.

The maximum permissible power dissipation (P_{max}), which depends on the dimensions of the capacitor and on the ambient free air temperature can be found from fig.16.

In applications where sine waves occur, we have to take for U the RMS-voltage or for I the RMS-current of the sine wave.

In applications where periodic signals occur, the signal has to be expressed in Fourier-terms:

$$U = U_0 + \sum_{k=1}^{\infty} \sin(k\omega t + \varphi_k) \quad (6)$$

Metallized polyethyleneterephthalate film capacitors

2222 365/366/367/368/369

$$I = \sum_{k=1}^{\infty} I_k \sin(k\omega t + \varphi_k) \quad (7)$$

with U_0 the D.C.voltage, U_k and I_k the voltage resp. current of the k-th harmonic.

We become for the dissipated power :

$$\text{with (6)} \quad P = \sum_{k=1}^{\infty} k \cdot w \cdot c \cdot \tan_{\Delta} \cdot \frac{U_k^2}{2} \quad (8)$$

$$\text{with (7)} \quad P = \sum_{k=1}^{\infty} \frac{\tan_{\Delta k} \cdot I_k^2}{k \cdot w \cdot C \cdot 2} \quad (9)$$

and $\tan_{\Delta k}$ is the \tan_{Δ} at the k-th harmonic.

Maximum dissipation as a function of ambient free air temperature.

Fig. 16a : 2222 365 - 366 - 367

curve	dimensions (mm)	
	b_max	l_max
1	3,5	7,5
2	4	7,5
3	4,5	7,5
4	5	7,5
5	5,5	7,5
6	6	7,5
7	4	10
8	4,5	10,5
9	5	10,5
10	5,5	10,5
11	6	10,5

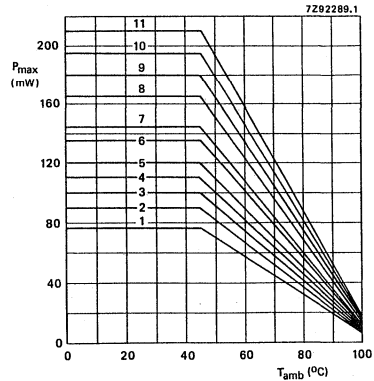

Metallized polyethyleneterephthalate film capacitors

2222 365/366/367/368/369

Fig. 16b : 2222 368 - 369

curve	dimensions (mm)	
	b_max	l_max
1	4	12,5
2	4,5	12,5
3	5	12,5
4	5,5	12,5
5	6	12,5
6	6,5	12,5
7	5	17,5
8	5,5	17,5
9	6	17,5
10	6,5	17,5
11	7	17,5
12	7,5	17,5
13	8	17,5
14	8,5	17,5
15	5	26
16	5,5	26
17	6	26
18	6,5	26
19	7	26
20	7,5	26
21	8	26
22	8,5	26
23	8	30
24	9	30
25	9,5	30
26	10	30
27	10,5	30
28	11	30
29	11,5	30
30	12	30
31	12,5	30
32	13	30
33	13	30

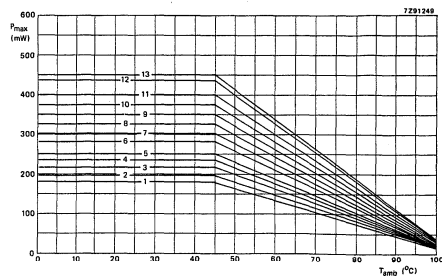
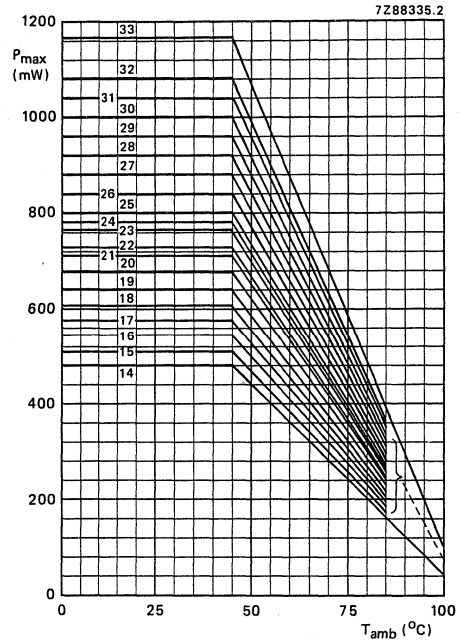

**Metallized polyethyleneterephthalate
film capacitors**

2222 365/366/367/368/369

1.3.10 Application note

To select this capacitor for a certain application you have to check 6 conditions :

1. The peak voltage (U_p) shall not be greater than the rated d.c. voltage.
2. The peak to peak voltage (U_{pp}) shall not be greater than $2\sqrt{2}$ times the rated a.c. voltage, to avoid the ionisation inception level.
3. The peak current (I_p) shall not exceed the maximum peak current, defined as maximum voltage pulse slope (dU/dt) multiplied by the capacitance.

$$I_p \text{ max} = C \left(\frac{dU}{dt} \right) \text{ max.}$$

Or the voltage pulse slope shall not exceed the rated voltage pulse slope.
If the pulse voltage is lower than the rated voltage, the values of tabel 1.3.7 may be multiplied by U_{Rdc} and divided by applied voltage.

4. The dissipated power shall not be greater than the maximum permissible power dissipation stated in 1.3.9.
5. The free air ambient temperature for the capacitor is not exceeding the category temperature.
6. Since all metallised film capacitors have always intrinsically active flammability risk, it is recommended to use these capacitors only in these circuits where in case of failure of the capacitor the power can be limited to less than 5 VA to the capacitor.

Metallized polyethyleneterephthalate film capacitors

2222 365/366/367/368/369

Example of using Fig. 14 and 16

A capacitor of 0.1 μ F should be used at a sine voltage of 10 Vrms, a frequency of 10 kHz and an ambient free air temperature of 50°C.

The tan δ is 0.01 (from Fig.14), so that the power to be dissipated is :

$$\begin{aligned} P &= \omega \cdot C \cdot \tan_{\delta} \cdot U^2 \\ &= 2\pi \cdot 10^4 \cdot 0,1 \cdot 10^{-6} \cdot 0,01 \cdot 100 \text{ W} \\ &= 6,3 \text{ mW} \end{aligned}$$

Is it possible to use a 0,1 μ F/63V capacitor ?

Checking the 6 conditions

1. The peak voltage $V_p = 14 (\sqrt{2} \times 10)$ is lower than 63Vdc.
2. The peak to peak voltage $28V_{pp}$ is lower than 25Vac $2\sqrt{2} = 70V_{pp}$
3. Because of the sinewave, we have not to check the pulse conditions.
4. The dissipated power is : 6,3 mW
This is less than 132 mW at 50°C for its dimensions 4 x 10 ,
seen in fig. 16a.
5. The free air ambient temperature is 50°C, and lower than 100°C.
6. In case of failure, the power is switched off.

Metallized polyethyleneterephthalate film capacitors

2222 365/366/367/368/369

1.4. Related documents

Generic specification	IEC 384-1
Sectional specification	IEC 384-2

1.5. Marking

1.5.1 Style 2222 365, 2222 366, 2222 367

The capacitors with a terminal pitch of 5,08mm are marked in black ink on the top with the following information :

- ° Capacitance in pF or μ F
- ° Capacitance tolerance M : 20% K : 10% J : 5%
- ° Rated voltage (e.g. 63)

Example : 0.047
K 63

The capacitors with a terminal pitch of 5,08 (7,62)mm or 7,62 mm are marked in black ink on the top with the following information :

- ° Capacitance in pF or μ F
- ° Capacitance tolerance M : 20% K : 10% J : 5%
- ° Rated voltage (e.g. 100)
- ° Code for diëlectric material (MKT)

Example : 0.047 K
100 MKT

1.5.2 Style 2222 368, 2222 369

The capacitors are marked in black ink on the top with the following information :

- ° Capacitance in pF or μ F
- ° Capacitance tolerance M : 20% K : 10% J : 5%
- ° Rated voltage (e.g. 250V)
- ° Code for diëlectric material (MKT)
- ° Manufacturer's name (PHILIPS)
- ° Code for factory of origin (HQ)

Example : PHILIPS | 0.39 μ F 20% |
250V- MKT | HQ

Metallized polyethyleneterephthalate film capacitors

2222 365/366/367/368/369

The package containing the capacitors is marked as follows

Data on label SPQ and PQ
(example)

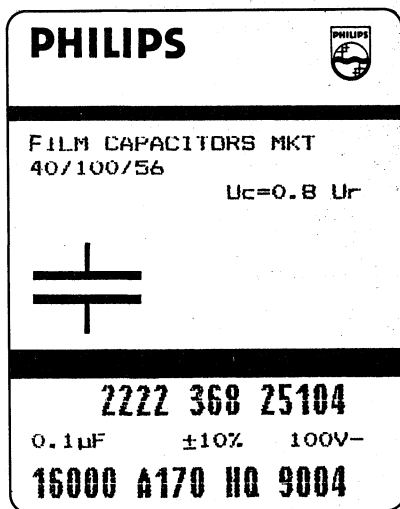

Block A : Philips word mark and emblem

Block B : Line 1 : Film capacitors and material code
Line 2 : Climatic group number and category voltage
Line 3 : Country standard

Capacitor symbol

Block C : Line 1 : Product code (12 NC)

Line 2 : Capacitance value
<10 K in pF followed by pF
>10K in µF followed by µF
Tolerance followed by ± and %
Voltage followed by V-

Line 3 : Number of capacitors
Preference-origin code : A
Country of origin : Belgium=170
Responsible production centre :
Philips Roeselare = HQ
Production period : year- and week code (4 digits)

1.6. Ordering information

Order the capacitors by quoting the 12-digit catalogue number as shown in Tables 1 to 28.

1.7. Certified test records (CTR)

Not required.

**Metallized polyethyleneterephthalate
film capacitors**

2222 365/366/367/368/369

2. INSPECTION REQUIREMENTS

Note 1 : Sub-clause numbers of tests and performance requirements refer to the Sectional Specification, IEC-publication 384-2 and Section One of this specification.

Note 2 : Inspection levels and AQL's are selected from IEC-Publication 410 : Sampling Plans and Procedures for Inspection by attributes.

Note 3 : In this table :

- p = periodicity (in months)
- n = sample size
- c = acceptance criterion (permitted number of defectives)
- D = destructive
- ND = non-destructive
- IL = inspection level) IEC 410
- AQL = acceptable quality level)

Note 4 : For this capacitor, considered as a solid construction, it is permitted to reduce the periodicity of the vibration and shock test from 6 months to 36 months.
In the event of a single defective occurring in subgroup Clb at this reduced rate of testing, then the vibration and shock tests shall revert to a 6 monthly periodicity until three successive 6-monthly tests shall have produced no defectives.

**Metallized polyethyleneterephthalate
film capacitors**
2222 365/366/367/368/369

Clause number and Test (see Note 1)	D or ND	Conditions of Test (see Note 1)	IL (see Note 2)	AQL	Performance requirements (see Note 1)
<u>Group A Inspection (lot-by-lot)</u>					
<u>Sub-group A1</u>					
4.1 Visual examination	ND		I	2,5%	- No mechanical failures - Legible marking and as specified in GENERAL DATA of this specification.
4.2 Dimensions		Gauging			- As specified in Tables in GENERAL DATA
<u>Sub-group A2</u>					
4.2.1 Voltage proof (Test A)	ND	at $1,6xU_{Rdc}$ for 1 s.	II	1%	- No breakdown or flashover
4.2.2 Capacitance		at 1kHz			- Within specified tolerance
4.2.3 Tangent of loss angle		for $C < 470nF$ at 100 kHz for $C > 470nF$ at 10 kHz			- As in GENERAL DATA of this specification
4.2.4 Insulation resistance (Test A)		at 10V for $U_R = 63V$ at 100V for $U_R = 100V$ 250V 400V at 500V for $U_R = 630V$			- As in GENERAL DATA of this specification

Metallized polyethyleneterephthalate film capacitors

2222 365/366/367/368/369

Sub-clause number and Test (see Note 1)	D or ND	Conditions of test (see Note 1)	Sample size + criterion of accepta- bility (see Note 3)			Performance requirements
			p	n	c	
Group C inspection (periodic)						
Sub-group CIA	D		6	9	1	
Part of sample of Sub-group C1						
4.1 Dimensions (detail)						As specified in GENERAL DATA
4.3.1 Initial measurements		Capacitance Tangent of loss angle for $C < 470\text{nF}$ at 100kHz $C > 470\text{nF}$ at 10kHz				
4.3 Robustness of terminations		Tensile and bending				No visible damage
4.4 Resistance to soldering heat		Method : 1A Solder bath : 260°C Duration : 10 s				
4.14 Component solvent resistance		Mixture 1,1,2- trichlorotrifluoro- ethane and 2- propanol(isopropyl- alcohol) Temperature : 48,6 to 50,5°C (boiling) Method : 2 Immersion time : 5 ± 0,5 min. Recovery time : min.1h max. 2h				
4.4.2 Final measurements		Visual examination Capacitance Tangent of loss angle				No visible damage Legible marking $\frac{\Delta C}{C} < 2\%$ of the va- lue measured initially Increase of tan delta $< 0,005$ for $C < 100\text{nF}$ $< 0,01$ for $C > 100\text{nF}$ $< 220\text{nF}$ $< 0,015$ for $C > 220\text{nF}$ $< 470\text{nF}$ $< 0,003$ for $C > 470\text{nF}$ compared to values measured in 4.3.1

Metallized polyethyleneterephthalate film capacitors

2222 365/366/367/368/369

Sub-clause number and Test (see Note 1)	D or ND	Conditions of test (see Note 1)	Sample size + criterion of acceptability (see Note 3)			Performance requirements
			p	n	c	
<u>Sub-group ClB</u> Other part of sample of Sub-group Cl 4.6.1 Initial measurements 4.6 Rapid change of temperature 4.7 Vibration (see Note 4) 4.7.2 Final inspection 4.9 Shock (see Note 4)	D	Capacitance Tangent of loss angle for $C < 470nF$ at 100kHz $C > 470nF$ at 10kHz θA =lower cat. temp. θB =upper cat. temp. 5 cycles Duration $t = 30min.$ Visual examination Method of mounting see GENERAL DATA of this specification. Procedure B4. Frequency range : 10Hz to 55Hz. Amplitude 0,75mm or acceleration $98m/s^2$ (whichever is the less severe) Total duration 6h Visual examination Method of mounting see GENERAL DATA of this specification Pulse shape : half sine Accelerat.: $490m/s^2$ Duration of pulse : 11ms	6	18	1	No visible damage No visible damage

**Metallized polyethyleneterephthalate
film capacitors**

2222 365/366/367/368/369

Sub-clause number and Test (see Note 1)	D or ND	Conditions of test (see Note 1)	Sample size + criterion of accepta- bility (see Note 3)			Performance requirements
			p	n	c	
4.9.3 Final measurements		Visual examination Capacitance				No visible damage $\Delta C < 3\%$ of the va- lue measured in 4.6.1
		Tangent of loss angle				Increase of $\tan \delta$ $< 0,005$ for $C < 100nF$ $< 0,01$ for $C > 100nF$ $< 220nF$ $< 0,015$ for $C > 220nF$ $< 470nF$
		Insulation resistance				$< 0,003$ for C compared to values measured in 4.6.1 As in GENERAL DATA of this specifica- tion.

**Metallized polyethyleneterephthalate
film capacitors**

2222 365/366/367/368/369

Sub-clause number and Test (see Note 1)	D or ND	Conditions of test (see Note 1)	Sample size + criterion of accepta- bility (see Note 3)			Performance requirements
			p	n	c	
<hr/>						
<u>Sub-group C1</u>	D		6	27	2	
Combined sample of spe- cimens of Sub-groups C1A and C1B						
4.10 Climatic sequence						
4.10.2 Dry heat		Temperature : upper category temperature Duration : 16h				
4.10.3 Damp heat cyclic, Test Db, first cycle						
4.10.4 Cold		Temperature : lower category temper. Duration : 2h				
4.10.6 Damp heat cyclic, Test Db remaining cycles						
4.10.6.2 Final measurements		Visual examination Capacitance Tangent of loss angle Insulation resistance				No visible damage Legible marking $\frac{\Delta C}{C} \leq 5\%$ of value measured in 4.4.2. or 4.9.3. Increase of tan delta $< 0,007$ for C $\leq 100nF$ $< 0,01$ for C $> 100nF$ $< 220nF$ $< 0,015$ for C $> 220nF$ $< 470nF$ $< 0,005$ for C $> 470nF$ compared to values measured in 4.3.1 or 4.6.1 $> 50\%$ of values in GENERAL DATA of this specification

**Metallized polyethyleneterephthalate
film capacitors**

2222 365/366/367/368/369

Sub-clause number and Test (see Note 1)	D or ND	Conditions of test (see Note 1)	Sample size + criterion of accepta- bility (see Note 3)			Performance requirements
			p	n	c	
<hr/>						
<u>Sub-group C2</u>	D		6	15	1	
4.11 Damp heat steady state		56 days, 40°C 90 - 95% R.H.				
4.11.1 Initial measurements		Capacitance Tangent of loss angle for C < 470nF at 100kHz C > 470nF at 10kHz				
4.11.3 Final measurements		Visual examination Capacitance Tangent of loss angle Insulation resistance				No visible damage Legible marking $\Delta C < 5\%$ of the \bar{C} value measu- red in 4.11.1 Increase of tan delta: <0,007 for C <100nF <0,01 for C >100nF <220nF <0,015 for C >220nF <470nF <0,005 for C >470nF compared to values measured in 4.11.1 >50% of values in GENERAL DATA of this specification

**Metallized polyethyleneterephthalate
film capacitors**

2222 365/366/367/368/369

Sub-clause number and Test (see Note 1)	D or ND	Conditions of test (see Note 1)	Sample size + criterion of accepta- bility (see Note 3)			Performance requirements
			p	n	c	
<u>Sub-group C3</u>	D		3	21	1	
4.12 Endurance		Duration : 2000 h 1,25U _{Rdc} at 85°C 1,25U _C at 100°C				
4.12.1 Initial measurements		Capacitance Tangent of loss angle for C < 470nF at 100kHz C > 470nF at 10kHz				
4.12.5 Final measurements		Visual examination Capacitance Tangent of loss angle Insulation resistance				No visible damage Legible marking $\frac{\Delta C}{C} < 5\%$ of value measured in 4.12.1 Increase of tan delta $< 0,005$ for C $< 100nF$ $< 0,01$ for C $> 100nF$ $< 220nF$ $< 0,015$ for C $> 220nF$ $< 470nF$ $< 0,003$ for C $> 470nF$ compared to values measured in 4.12.1 $> 50\%$ of values in GENERAL DATA of this specification

**Metallized polyethyleneterephthalate
film capacitors**

2222 365/366/367/368/369

Sub-clause number and Test (see Note 1)	D or ND	Conditions of test (see Note 1)	Sample size + criterion of accepta- bility (see Note 3)			Performance requirements
			p	n	c	
<u>Sub-group C4</u>	D		3	9	1	
4.13 Charge and discharge		10 000cycles(50c/s) charge to U_R half sine wave Duration : 5 ms discharge $R =$ $\frac{U_R}{C \cdot 2,5 \left(\frac{dU}{dt} \right)_R}$ with a min. of $2,2\Omega$				
4.13.1 Initial measurements		Capacitance Tangent of loss angle for $C < 470nF$ at 100kHz $C > 470nF$ at 10kHz				
4.13.3 Final measurements		Capacitance Tangent of loss angle Insulation resistance				$\Delta \frac{C}{C} \leq 3\%$ of value measured in 4.13.1 Increase of tan delta $\leq 0,005$ for $C < 100nF$ $\leq 0,01$ for $C > 100nF$ $\leq 220nF$ $\leq 0,015$ for $C > 220nF$ $\leq 470nF$ $\leq 0,003$ for $C > 470nF$ $> 50\%$ of values in GENERAL DATA of this specification

Metallized polyethyleneterephthalate film capacitors

2222 365/366/367/368/369

Additional tests	or ND	Conditions of test	+ criterion of accepta- bility			Performance requirements
			p	n	c	
<hr/>						
<u>Sub-group ADD1</u>						
A.1 Solderability	D	Without ageing Method : 1 Non-activated colo- phony flux 501 solderbath:235°C Dwell time :2 s.	3	35	1	Good tinning as evidenced by free flowing of the solder with wetting of the terminations (>95 %)
Solvent resistance of the marking		Mixture 1,1,2- trichlorotrifluoro- ethane and 2- propanol (isopropylalcohol) Temperature : 48,6 to 50,5°C (boiling) Method 1 Rubbing material : cotton wool Immersion time : 5 ± 0,5 min.				Legible marking
<hr/>						
<u>Sub-group ADD2</u>	D		3	12	1	
A.2 Heat storage		Duration : 2000h Temperature : upper category temperature				
A.2.1 Initial measurements		Capacitance Tangent of loss angle for C < 470nF at 100kHz C > 470nF at 10kHz				
A.2.2 Final measurements		Capacitance Tangent of loss angle Insulation resistance				$\frac{\Delta C}{C} < 3\%$ of value measured in A.2.1 Increase of tan delta <0,005 for C <100nF <0,01 for C >100nF <220nF <0,015 for C >220nF <470nF <0,003 for C >470nF compared to values measured in A.2.1 As in GENERAL DATA of this specifi- cation.

Metallized polyethyleneterephthalate film capacitors

2222 365/366/367/368/369

Additional tests	D or ND	Conditions of test	Sample size + criterion of accepta- bility			Performance requirements
			p	n	c	
<u>Sub-group ADD3</u>			3	9	1	
A.3 Endurance for capacitors with max. a.c. voltage ≥ 200 V r.m.s.		Duration : 1000h Temperature : 85°C Voltage: $1,25 \times$ max. a.c. voltage (r.m.s. value) 50 Hz				
A.3.1 Initial measurements		Capacitance Tangent of loss angle for C < 470 nF at 100kHz C > 470 nF at 10kHz				
A.3.2 Final measurements		Capacitance Tangent of loss angle Insulation resistance				$\Delta C < 5\%$ of value C measured in A.3.1 Increase of tan delta $< 0,005$ for C ≤ 100 nF $< 0,01$ for C > 100 nF < 220 nF $< 0,015$ for C > 220 nF < 470 nF $< 0,003$ for C > 470 nF compared to values measured in A.3.1 As in GENERAL DATA of this specification.

**Metallized polyethyleneterephthalate
film capacitors**

2222 365/366/367/368/369

Additional tests	D or ND	Conditions of test	Sample size + criterion of accepta- bility			Performance requirements
			p	n	c	
<u>Sub-group ADD4</u>			3	9	1	
A.4 Detergent resistance		Density 20g/l dishwasher detergent Temperature 70°C during 3 min. Followed by rinsing in clear water for 1 min. Recovery time 1to2h				
A.4.1 Initial measurements		Capacitance Tangent of loss angle for C < 470nF at 100kHz C > 470nF at 10kHz				
A.4.2 Final measurements		Capacitance Tangent of loss angle Insulation resistance				$\frac{\Delta C}{C} < 1\%$ of value measured in A.4.1 Increase of tan delta <0,005 for C <100nF <0,01 for C >100nF <220nF <0,015 for C >220nF <470nF <0,003 for C >470nF compared to values measured in A.4.1 > 50% of values in GENERAL DATA of this specification.

**Metallized polyethyleneterephthalate
film capacitors**

2222 365/366/367/368/369

Additional tests	D or ND	Conditions of test	Sample size + criterion of accepta- bility			Performance requirements
			p	n	c	
Sub-group ADD5						
A.5 Resistance to soldering heat with preheating.	D	Capacitors mounted on a 1,6mm board with nonplated holes Body temp. : 80°C Bath temp. : 260°C Dwell time : 2x5s with interim free period of 5s.	6	15	1	
A.5.1 Initial measurements		Capacitance Tangent of loss angle for C < 470nF at 100kHz C > 470nF at 10kHz				
A.5.2 Final measurements		Capacitance Tangent of loss angle				$\Delta \frac{C}{C} < 2\%$ for C < 10nF $\frac{C}{C} < 1\%$ for C > 10nF of value measured in A.5.1 Increase of tan delta < 0,005 for C < 100nF < 0,01 for C > 100nF < 220nF < 0,015 for C > 220nF < 470nF < 0,003 for C > 470nF compared to values measured in A.5.1
Sub-group ADD6						
A.6 Climatic test on taped type for style 2222 365		10 days at 40 + 2°C R.H. 90 to 95% Recovery time 24h	3	15	0	Change in position of lead hole over 20 pitch distances < 0,5mm. Angle of component < 4° Pull out and tearing forces > 50% of values in GENERAL DATA of this specification

Interference suppression

Philips Components

Data sheet	
status	Product specification
date of issue	May 1990

2222 330 4..../5....**Interference suppression capacitors**

MKT-P Radial potted types

- ° 15 to 27,5mm terminal pitch
- ° Supplied loose in box and taped on reel

QUICK REFERENCE DATA

Capacitance range (E6-series) *	
style 2222 330 4....	0,01 to 1 μ F
style 2222 330 5....	0,01 to 0,68 μ F
Capacitance tolerance	<u>±</u> 20%, <u>±</u> 10%
Rated voltage U _{Rac} , 50 to 60 Hz	250V
Climatic category	40/085/21
Application class according to DIN 40040	GPF
Rated temperature	85°C
Related specification	IEC 384-14
Qualifications for style 2222 330 4....	VDE 565-1, IMQ (CEI 40-7), Semko, UL 1283
style 2222 330 5....	VDE 565-1, FI, Semko, UL 1283
Materials classified according to UL	94V-0 (3,2) 94V-1 (1,6)
Performance class	X2

* Intermediate values of the E12 series, are available to special order.

Interference suppression capacitors

2222 330 4..../5....

SURVEY OF STYLES

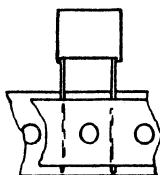

Style	terminal pitch	table
2222 330 4....	15mm	1
5....		3

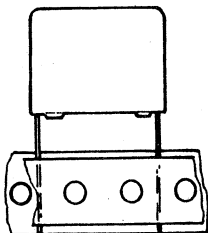
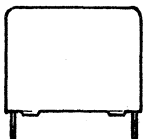

2222 330 4....	22,5 and 27,5mm	2
5....		4

CONSTRUCTION

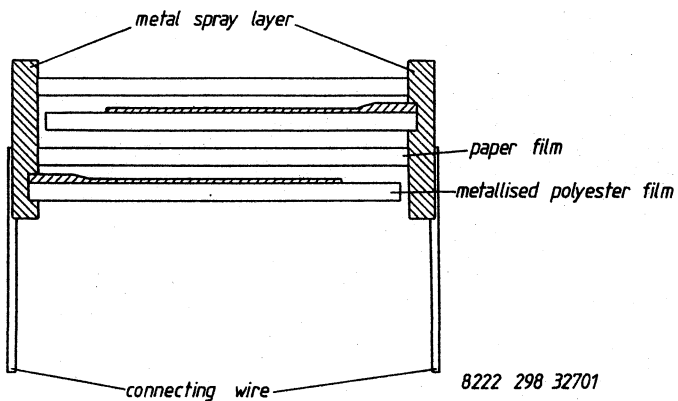

Interference suppression capacitors

2222 330 4..../5....

APPLICATION

For radio interference suppression in :

- small household appliances, e.g. coffee grinders, mixers;
- general industrial applications, e.g. test and measuring equipment.
- audio and TV circuits.

Due to the dual dielectric construction active flammability under fault conditions is prevented.

DESCRIPTION

The capacitors consist of an impregnated low-inductive wound cell of metallized polyethyleneterephthalate (PETP) film and paper film. The cell is potted with blue epoxy resin in a blue flame retardent polypropylene case. The radial leads are of solder-coated wire.

The capacitors can withstand solvents and rinsing liquids without damage.

They are provided with small stand-off pips to allow removal of solder flux etc., during cleaning, of the printed-wiring board.

1. GENERAL DATA

1.1. Mounting

Normal use

The capacitors are designed for printed wiring applications.

The capacitors packed on bandoliers are designed for mounting on printed-wiring boards by means of automatic insertion machines.

Specific method of mounting to withstand vibration and shock

In order to withstand vibration and shock tests, it must be ensured that the stand-off pips are in good contact with the printed-wiring board. For case sizes up to and including a mass of 6g. the capacitors shall be mechanically fixed by the leads.

With larger case sizes the capacitors shall be mounted in the same way and the body shall be clamped.

For capacitors with insulated leads the body shall be clamped.

Interference suppression capacitors

2222 330 4..../5....

1.2.1 Dimensions in mm.

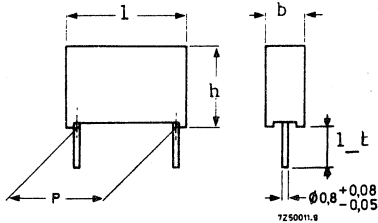

Fig. 1

Table 1

Style : 2222 330 4....
 Qualified according to : VDE 565-1
 INQ (CEI 40-7)
 Semko
 UL 1283

capacitance	b_max	h_max	l_max	P	mass	catalogue number 2222 330						
						loose in box Fig. 1				taped on reel Fig. 3		
						l_t = 5+ 1		l_t = 25 + 2				
						C-tol +20%	C-tol +10%	C-tol +20%	C-tol +10%	C-tol +20%	C-tol +10%	
0,010	5	11	17,5	15+0,4	1,2	40103	41103	44103	45103	42103	43103	
0,015	5	11	17,5			40153	41153	44153	45153	42153	43153	
0,022	5	11	17,5			40223	41223	44223	45223	42223	43223	
0,033	5	11	17,5			40333	41333	44333	45333	42333	43333	
0,047	6	12	17,5			1,4	40473	41473	44473	45473	42473	43473
0,068	7	13,5	17,5			2	40683	41683	44683	45683	42683	43683
0,10	8,5	15	17,5			2,6	40104	41104	44104	45104	42104	43104

Interference suppression capacitors

2222 330 4..../5....

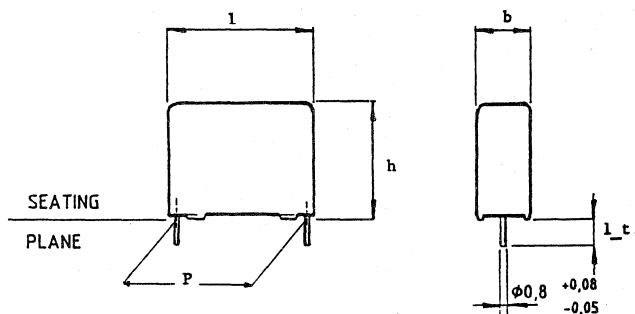

Fig. 2

Table 2

Style : 2222 330 4....
 Qualified according to : VDE 565-1
 IMQ (CEI 40-7)
 Senko
 UL 1283

capacitance	b_max	h_max	l_max	P	mass	catalogue number 2222 330					
						loose in box Fig. 2				taped on reel Fig. 4	
						l_t = 5+1		l_t = 25 + 2			
						C-tol +20%	C-tol +10%	C-tol +20%	C-tol +10%	C-tol +20%	C-tol +10%
0,15	7	16,5	26	22,5	3,0	40154	41154	44154	45154	42154	43154
0,22	8,5	18	26	+0,4	3,7	40224	41224	44224	45224	42224	43224
0,33	10	19,5	26		5,4	40334	41334	44334	45334	42334	43334
0,47	13	23	31	27,5	10,8	40474	41474	44474	45474	42474	43474
0,68	15	25	31	+0,4	12,9	40684	41684	44684	45684	42684	43684
1	18	28	31		18,2	40105	41105	44105	45105	42105	43105

Interference suppression capacitors

2222 330 4..../5....

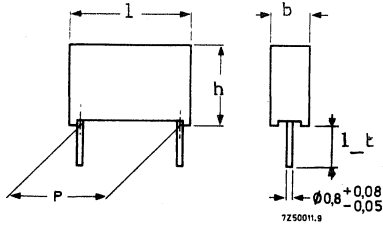

Fig. 1

Table 3

Style : 2222 330 5....
 Qualified according to : VDE 565-1
 FI
 Semko
 UL 1283

capacitance	b_max	h_max	l_max	P	mass	catalogue number 2222 330					
						loose in box Fig. 1				taped on reel Fig. 3	
						l_t = 5 + 1		l_t = 25 + 2			
						C-tol +20%	C-tol +10%	C-tol +20%	C-tol +10%	C-tol +20%	C-tol +10%
0,010	6	12	17,5		1,4	50103	51103	54103	55103	52103	53103
0,015	7	13,5	17,5		2	50153	51153	54153	55153	52153	53153
0,022	8,5	15	17,5		2,6	50223	51223	54223	55223	52223	53223
0,033	8,5	15	17,5	15+0,4	2,6	50333	51333	54333	55333	52333	53333
0,047	8,5	15	17,5		2,6	50473	51473	54473	55473	52473	53473

Interference suppression capacitors

2222 330 4..../5....

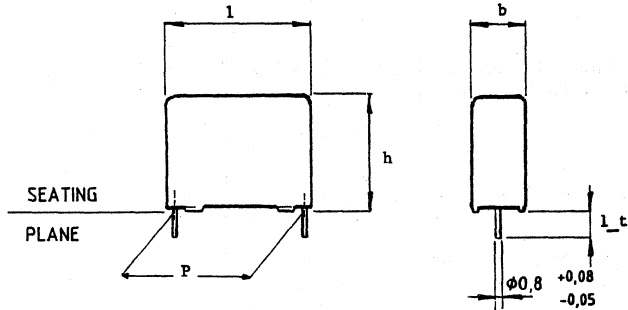

Fig. 2

Table 4

Style : 2222 330 5....
 Qualified according to : VME 565-1
 FI
 Semko
 UL 1283

capacitance	b_max	h_max	l_max	P	mass	catalogue number 2222 330					
						loose in box Fig. 2				taped on reel Fig. 4	
						l_t = 5 + 1		l_t = 25 + 2			
						C-tol +20%	C-tol +10%	C-tol +20%	C-tol +10%	C-tol +20%	C-tol +10%
μF					g						
0,068	7	16,5	26	22,5	3,0	50683	51683	54683	55683	52683	53683
0,10	8,5	18	26	+0,4	3,7	50104	51104	54104	55104	52104	53104
0,15	10	19,5	26		5,4	50154	51154	54154	55154	52154	53154
0,22	11	21	31		3,7	50224	51224	54224	55224	52224	53224
0,33	13	23	31	27,5	10,8	50334	51334	54334	55334	52334	53334
0,47	13	23	31	+0,4	10,8	50474	51474	54474	55474	52474	53474
0,68	15	25	31		18,2	50684	51684	54684	55684	52684	53684

Interference suppression capacitors

2222 330 4..../5....

1.2.2 Packing

The capacitors are supplied loose in box or taped on reel, details of quantities are given in Tables and 5 to 7.

Loose in box

Table 5 : Number of capacitors per box.

\underline{l}_{\max} mm	\underline{b}_{\max} mm	Number of capacitors per box			
		$\underline{l}_t = 5 + 1\text{mm}$		$\underline{l}_t = 25 + 2\text{mm}$	
		SPQ	PQ	SPQ	PQ
17,5	$\begin{matrix} < 6 \\ \geq 7 \end{matrix}$	1000	4000	$\begin{matrix} 1000 \\ 500 \end{matrix}$	$\begin{matrix} 4000 \\ 2000 \end{matrix}$
26		200	1000	500	500
31		100	500	125	500

Interference suppression capacitors

2222 330 4..../5....

Reel packing

1. Dimensions of taped products

Capacitors with pitch $P = 15\text{mm}$, Fig. 3.

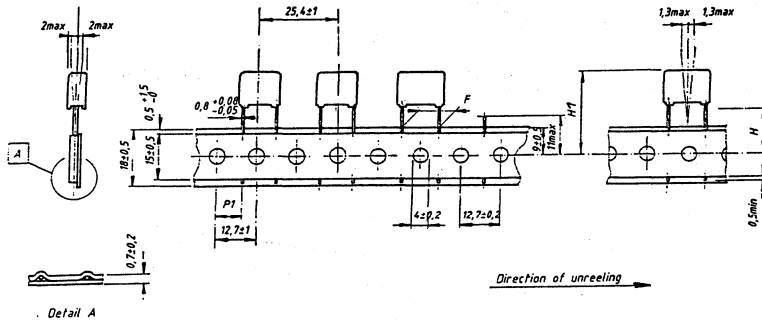

FOR PHYSICAL DIMENSIONS SEE PRODUCT SPECIFICATION

ITEM	SYMBOL	VALUE	VALUE	TOLERANCE
Lead to lead distance	F	10	15	+0.5/-0.1
Height of comp. from tape center to seating plane	H		18,5	±0,5
Component height from tape center	H1	max 32	max 35	for h = 18,5
Feed hole to leadcenter	P1	7,7	5,2	±0,7

Capacitors with pitch $P = 22,5$ or $27,5\text{mm}$, Fig. 4.

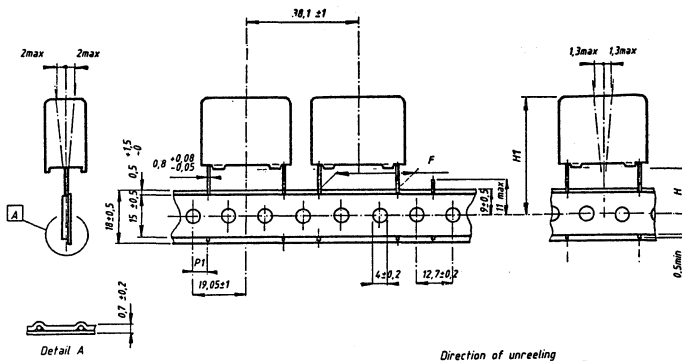

FOR PHYSICAL DIMENSIONS SEE PRODUCT SPECIFICATION

ITEM	SYMBOL	VALUE	VALUE	TOLERANCE
Lead to lead distance	F	22,5	27,5	+0.5/-0.1
Height of component from tape center to seating plane	H		18,5	±0,5
Component height from tape center	H1	max 40	max 48	for h=18,5
Feed hole to lead center	P1	7,8	5,33	±0,7

Interference suppression capacitors

2222 330 4..../5....

2. Characteristics of taped products

Pull-out force of the component	>5N
Pull-off force of the adhesive tape	≥6N
Tearing force of tape	≥15N
Storage conditions	
storage temperature	-25°C to +40°C
relative humidity	RH max. 80% without condensation

3. Outlines of reel-packaging

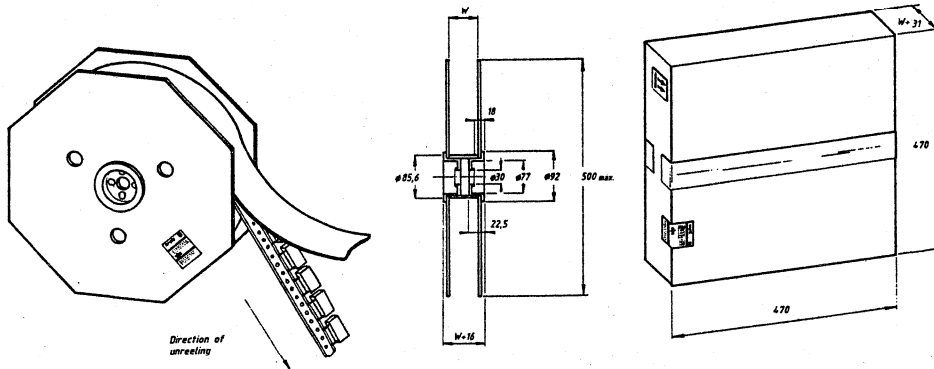

Fig. 5

Interference suppression capacitors

2222 330 4..../5....

4. Number of capacitors per reelTable 6 : l_{\max} 17,5mm

b_{\max} mm	Number per reel	$W + 2\text{mm}$
5	1100	45
6	900	45
7	800	45
8,5	650	50

Table 7 : l_{\max} 26 or 31mm

b_{\max} mm	Number per reel	$W + 2\text{mm}$
7	550	50
8,5	450	50
11	300	55
13	250	55
15	200	60
18	150	60

The max. number of empty places per reel shall not exceed 0,5% of the total number of components per reel, but a max. of 2 consecutive components may be missing provided this gap is followed by 6 consecutive components.

1.3 Ratings and characteristics

Unless otherwise specified all electrical values apply to an ambient free air temperature of $23 \pm 1^\circ\text{C}$, an atmospheric pressure of 86 to 106 kPa and a relative humidity of $50 \pm 2\%$.

1.3.1 Capacitance

Capacitance range at 1 kHz see Tables

Capacitance tolerance see Tables

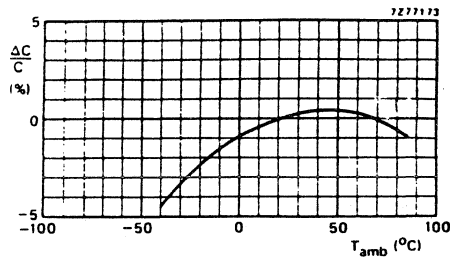

Fig. 6 : Capacitance as a function of ambient free air temperature; typical curve.

Interference suppression capacitors

2222 330 4..../5....**1.3.2 Voltage**

Rated voltage U_{Rac} (r.m.s. value),
50 to 60 Hz 250V

Test voltage
between terminations 1075V (d.c.)
between interconnected terminations
and case(foil method) 2000V (a.c.)

1.3.3 Climatic category 40/085/21

1.3.4 Rated temperature 85°C

1.3.5 Storage temperature range Temperature -25°C to +40°C
RH max. 80% without condensation

Interference suppression capacitors

2222 330 4..../5....

1.3.6 Tangent of loss angle

Tan_delta at 1 kHz	$\leq 75 \times 10^{-4}$
at 10 kHz	$\leq 130 \times 10^{-4}$

1.3.7 Rated voltage pulse slope

Maximum pulse load $\left(\frac{dU}{dt}\right)_R$	100V/ μ s
---	---------------

Resonant frequency

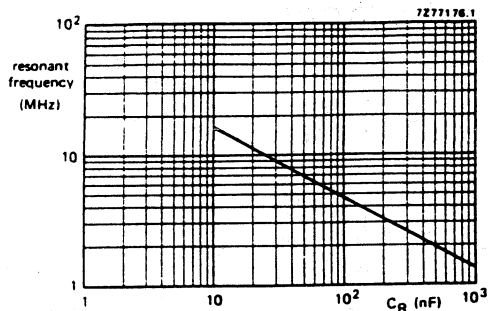

Fig. 7 Resonant frequency as a function of rated capacitance.

Interference suppression capacitors

2222 330 4..../5....

1.3.8 Insulation resistance at T_{amb} . 20°C

The insulation resistance is measured after a voltage of 100V \pm 15V has been applied for 1 min. \pm 5 s.

R between terminations, for $C \leq 0,33\mu\text{F}$ > 15 000 M Ω

RC between terminations, for $C > 0,33\mu\text{F}$ > 5 000 s.

R between interconnected terminations and case > 30 000 M Ω
(foil method)

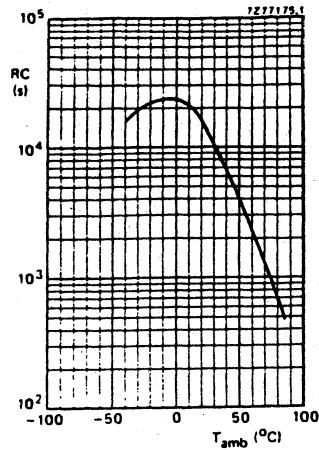

Fig. 8 : RC-product as a function of ambient free air temperature; typical curve.

Interference suppression capacitors

2222 330 4.../5....

1.4. Related documents

Generic specification	IEC 384-1
Sectional specification	IEC 384-14

1.5. Marking

The capacitors with l_{max} 17,5 are marked on the top by embossed print, capacitors with l_{max} 26 or 31 are marked on the top by laser print with the following information :

- Rated capacitance n : nF μ : μF
- Rated voltage (250V~)
- Capacitance tolerance M : 20% K : 10%
- Manufacturer's type designation (e.g. 330 40)
- Code for diëlectric material (MKT-P)
- Manufacturer's name (PHILIPS)
- Code for factory of origin (HQ)
- Climatic category (40/085/21)
- Capacitor class and subclass (X2)
- Approval marks of National Testing Stations (e.g. (S))
- Climatic category according to DIN (GPF)
- Production date code acc. to IEC-62, clause 5 for cap. with l_{max} 17,5mm
- Year and week of manufacture (e.g. 9010) for cap. with l_{max} 26 or 31mm

Examples : Cap. with l_{max} 17,5mm

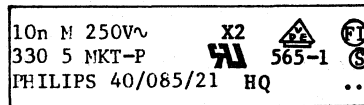
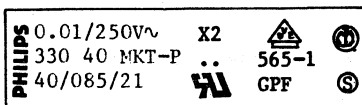

Cap. with l_{max} 26 or 31mm

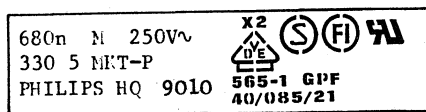
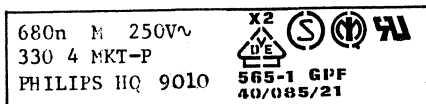

Interference suppression capacitors

2222 330 4..../5....

The package containing the capacitors is marked as follows

Data on label SPQ and PQ
(example)

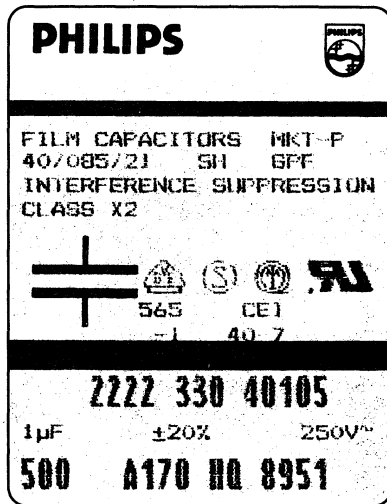

Block A : Philips word mark and emblem

Block B : Line 1 : Film capacitors and material code

Line 2 : Climatic category
SH = self-healing

Line 3 : Interference suppression capacitors

Line 4 : Class X2

Line 5 : Approbation symbols

Capacitor symbol

Block C : Line 1 : Product code (12 NC)

Line 2 : Capacitance value in μF
followed by μF

Tolerance followed by \pm and %

Voltage followed by $V\sim$

Line 3 : Number of capacitors

Preference-origin code : A

Country of origin : Belgium=170

Responsible production centre :

Philips Roeselare = HQ

Production period : year- and week code (4 digits)

1.6. Ordering information

Order the capacitors by quoting the 12-digit catalogue number as shown Tables 1 to 4.

1.7. Certified test records (CTR)

Not required.

Interference suppression capacitors

2222 330 4..../5....

2. INSPECTION REQUIREMENTS

Note 1 : Sub-clause numbers of tests and performance requirements refer to the Sectional Specification, IEC-publication 384-14 and Section One of this specification.

Note 2 : Inspection levels and AQL's are selected from IEC-Publication 410 : Sampling Plans and Procedures for Inspection by attributes.

Note 3 : In this table :

- p = periodicity (in months)
- n = sample size
- c = acceptance criterion (permitted number of defectives)
- D = destructive
- ND = non-destructive
- IL = inspection level) IEC 410
- AQL = acceptable quality level)

Note 4 : For this capacitor, considered as a solid construction, it is permitted to reduce the periodicity of the vibration and shock test from 6 months to 36 months.
In the event of a single defective occurring in subgroup Clb at this reduced rate of testing, then the vibration and shock tests shall revert to a 6 monthly periodicity until three successive 6-monthly tests shall have produced no defectives.

Interference suppression capacitors

2222 330 4..../5....

Clause number and Test (see Note 1)	D or ND	Conditions of Test (see Note 1)	IL (see Note 2)	AQL	Performance requirements (see Note 1)
<u>Group A Inspection (lot-by-lot)</u>					
<u>Sub-group A1</u>					
4.1 Visual examination	ND		I	2,5%	No mechanical failures Legible marking and as specified in GENERAL DATA of this specifi- cation.
4.2 Dimensions		Gauging			As specified in Tables of this specification
<u>Sub-group A2</u>					
4.2.2 Capacitance	ND	at 1kHz	II	1%	Within specified tolerance
4.2.3 Tangent of loss angle		at 10kHz			As in GENERAL DATA of this specification
4.2.1 Voltage proof (Test A)		at 1075V(d.c.) for 1 s.			No breakdown or flashover
4.2.4 Insulation resistance (Test A)		at 100V			As in GENERAL DATA of this specification

Interference suppression capacitors

2222 330 4.../5....

Sub-clause number and Test (see Note 1)	D or ND	Conditions of test (see Note 1)	Sample size + criterion of accepta- bility (see Note 3)			Performance requirements
			p	n	c	
Group C inspection (periodic)						
<u>Sub-group ClA</u>	D		6	9	1	
Part of sample of Sub-group Cl						
4.1 Dimensions (detail)						As specified in Tables of this specification
4.3.1 Initial measurements		Capacitance Tangent of loss angle at 10kHz				
4.3 Robustness of terminations		Tensile and bending				No visible damage
4.4 Resistance to soldering heat		Methode : 1A Solder bath : 260°C Duration : 10 s				
4.14 Component solvent resistance		Mixture 1,1,2- trichlorotrifluoro- ethane and 2 - propanol (isopro- pylalcohol) Temp.:48,6°to50,5°C (boiling) Method : 2 Immersion time : 5 + 0,5 min. Recovery time : min. 1h max. 2h				
4.4.2 Final measurements		Visual examination Capacitance Tangent of loss angle				No visible damage Legible marking $\Delta \frac{C}{C} < 2\%$ of the va- lue measured initially Increase of tan_delta <0,003 compared to values measured in 4.3.1

Interference suppression capacitors

2222 330 4..../5....

Sub-clause number and Test (see Note 1)	D or ND	Conditions of test (see Note 1)	Sample size + criterion of accepta- bility (see Note 3)			Performance requirements
			p	n	c	
Sub-group ClB Other part of sample of Sub-group Cl 4.6.1 Initial measurements	D	Capacitance Tangent of loss angle at 10kHz	6	18	1	
4.6 Rapid change of temperature		OA=lower cat. temp. OB=upper cat. temp. 5 cycles Duration t = 30min. Visual examination				No visible damage
4.7 Vibration (see Note 4)		Method of mounting see GENERAL DATA of this specification. Procedure B4. Frequency range : 10Hz to 55Hz. Amplitude 0,75mm or acceleration 98m/s ² (whichever is the less severe) Total duration 6h				
4.7.2 Final inspection		Visual examination				No visible damage
4.9 Shock (see Note 4)		Method of mounting see GENERAL DATA of this specification Pulse shape : half sine. Accelerat.:490m/s ² Duration of pulse : 11ms				
4.9.3 Final measurements		Visual examination Capacitance Tangent of loss angle Insulation resistance				No visible damage $\Delta C < 3\%$ of the \bar{C} value measured in 4.6.1 Increase of \tan_{Δ} $< 0,003$ compared to values measured in 4.6.1 As in GENERAL DATA of this speci- fication

Interference suppression capacitors

2222 330 4..../5....

Sub-clause number and Test (see Note 1)	D or NF	Conditions of test (see Note 2)	Sample size + criterion of accepta- bility (see Note 3)			Performance requirements
			p	n	c	
<u>Sub-group C1</u>	D		6	27	2	
Combined sample of spe- cimens of Sub-groups C1A and C1E						
4.10 Climatic sequence						
4.10.2 Dry heat		Temperature : upper category temperature Duration : 16h				
4.10.3 Damp heat cyclic, Test Db, first cycle						
4.10.4 Cold		Temperature : lower category temper. Duration : 2h				
4.10.6 Damp heat cyclic, Test Db remaining cycle						
4.10.6.2 Final measurements		Visual examination Capacitance Tangent of loss angle Insulation resistance Voltage proof 710V(d.c.), 1 min.				No visible damage Legible marking. $\Delta \frac{C}{C} \leq 3\%$ of value measured in 4.4.2. or 4.9.3. Increase of \tan_{δ} $< 0,005$ compared to values measured in 4.3.1 or 4.6.1 >50% of values in GENERAL DATA of this specification No breakdown or flashover.

Interference suppression capacitors

2222 330 4..../5....

Sub-clause number and Test (see Note 1)	D or ND	Conditions of test (see Note 1)	Sample size + criterion of accepta- bility (see Note 3)			Performance requirements	
			p	n	c		
<u>Sub-group C2</u>			D	6	15	1	
4.11 Damp heat steady state							
4.11.1 Initial measurements		Capacitance Tangent of loss angle at 10kHz					
4.11.3 Final measurements		Visual examination Capacitance Tangent of loss angle Insulation resistance Voltage proof 710V(d.c.), 1 min.					No visible damage Legible marking $\Delta \frac{C}{C} \leq 3\%$ of the C value measu- red in 4.11.1 Increase of tan δ : $< 0,005$ compared to values measured in 4.11.1 $> 50\%$ of values in GENERAL DATA of this specification No breakdown or flashover.
<u>Sub-group C3</u>			D	3	12	1	
4.12 Endurance		Duration : 1000 h 1,25 U _{Rac} at 85°C Once in each hour the voltage is in- creased to 1000V (r.m.s.) for 0,1s. via a resistor of 220Ω ± 10%					
4.12.1 Initial measurements		Capacitance Tangent of loss angle at 10kHz					

Interference suppression capacitors

2222 330 4.../5....

Sub-clause number and Test (see Note 1)	D or ND	Conditions of test (see Note 1)	Sample size + criterion of accepta- bility (see Note 3)			Performance requirements
			p	n	c	
4.12.5 Final measurements		Visual examination Capacitance Tangent of loss angle Insulation resistance Voltage proof 710V(d.c.), 1 min.				No visible damage Legible marking $\frac{\Delta C}{C} < 10\%$ of value measured in 4.12.1 Increase of $\tan \delta$ $< 0,003$ compared to values measured in 4.12.1 $> 50\%$ of values in GENERAL DATA of this specification No breakdown or flashover.
<u>Sub-group C4</u>	D		3	9	1	
4.13 Charge and discharge		10 000cycles(50c/s) charge to U_R half sinus wave Duration : 5 ms discharge $R =$ $\frac{U_R \cdot C \cdot \sqrt{2}}{C \cdot 5 \cdot \left(\frac{dU}{dt}\right)}$ with a min.R of $2,2\Omega$				
4.13.1 Initial measurements		Capacitance Tangent of loss angle at 10kliz				
4.13.3 Final measurements		Capacitance Tangent of loss angle Insulation resistance				$\frac{\Delta C}{C} \leq 3\%$ of value measured in 4.13.1 Increase of $\tan \delta$ $< 0,003$ $> 50\%$ of values in GENERAL DATA of this specification

Interference suppression capacitors

2222 330 4..../5....

Additional tests	D or ND	Conditions of test	Sample size + criterion of accepta- bility			Performance requirements
			p	n	c	
<hr/>						
<u>Sub-group ADD1</u> A.1 Solderability	D	Without ageing Method : 1 Non-activated colo- phany flux 501 Solder bath 235°C Dwell time : 2 s.	3	35	1	Good tinning as evidenced by free flowing of the solder with wet- ting of the ter- minations (>95%)
Solvent resistance of the marking		Mixture 1,1,2- trichlorotrifluoro- ethane and 2- propanol (isopropylalcohol) Temp.:48,6°Cto50,5°C (boiling) Method 1 Rubbing material : cotton wool Immersion time 5 + 0,5 min.				Legible marking
<hr/>						
<u>Sub-group ADD2</u> A.2 Heat storage	D	Duration : 1000h Temperature : upper category temperature	3	12	1	
A.2.1 Initial measurements		Capacitance Tangent of loss angle at 10kHz				
A.2.2 Final measurements		Capacitance Tangent of loss angle Insulation resistance				$\Delta \frac{C}{C} \leq 5\%$ of value C measured in A.2.1 Increase of tan_delta <0,003 compared to values measured in A.2.1 As in GENERAL DATA of this specifi- cation.

Interference suppression capacitors

2222 330 4..../5....

Additional tests	D or ND	Conditions of test	Sample size + criterion of accepta- bility			Performance requirements
			p	n	c	
<u>Sub-group ADD3</u>			3	9	1	
A.3 Detergent resistance		Density 20g/l Dishwasher detergent Temperature 70°C during 3 min. Followed by rinsing in clear water for 1 min. Recovery time 1to2h				
A.3.1 Initial measurements		Capacitance Tangent of loss angle at 10kHz				
A.3.2 Final measurements		Capacitance Tangent of loss angle Insulation resistance				$\Delta \frac{C}{C} \leq 2\%$ of value measured in A.3.1 Increase of $\tan \delta$ $< 0,003$ compared to values measured in A.3.1 $\geq 50\%$ of values in GENERAL DATA of this specification.

Interference suppression capacitors

2222 330 4..../5....

Additional tests	D or ND	Conditions of test	Sample size + criterion of accepta- bility			Performance requirements
			p	n	c	
<u>Sub-group ADD4</u>	D		6	15	1	
A.4 Resistance to solde- ring heat with pre- heating		Capacitors mounted on a 1,6mm board with nonplated holes Body temp. : 80°C Bath temp. : 260°C Dwell time : 2x5s with interim free period of 5s.				
A.4.1 Initial measurements		Capacitance Tangent of loss angle at 10kHz				
A.4.2 Final measurements		Capacitance Tangent of loss angle				$\frac{\Delta C}{C} < 2\%$ of value measured in A.4.1 Increase of \tan_{delta} <0,003 compared to values measured in A.4.1

Interference suppression capacitors

2222 330 4..../5....

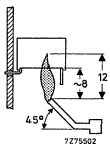
Additional tests	D or ND	Conditions of test	Sample size + criterion of accepta- bility			Performance requirements
			p	n	c	
<hr/>						
<u>Sub-group ADD5</u>	D		6	15	0	
A.5.1 Needle flame test IEC 40 (secr.)580 Class C		Core of gas jet : \varnothing 0,5mm Fuel : butane Test duration for actual volume V (mm ³) : < 250 : 5 s 250 < V < 500 = 10 s 500 < V < 1750 = 20 s V > 1750 = 30s One flame applica- tion.				After removing the test flame from the capacitor, the ca- pacitor must not continue to burn for more than 30s no burning parts must drop from the sample
						
<hr/>						
<u>Sub-group ADD6</u>	D		12	12	0	
Active flammability		Voltage proof up to 4 kVdc or untill breakdown (100V/sec, current limited 2mA) Failed capacitors connected to a 250Vac power supply during 5 minutes.				The capacitor shall not ignite a cheese cloth.

Philips Components

Data sheet	
status	Product specification
date of issue	May 1990

2222 331

Interference suppression capacitors

MKT/MKT Radial potted type

- ° 15 to 27,5mm terminal pitch
- ° Supplied loose in box and taped on reel

QUICK REFERENCE DATA

Capacitance range (E6-series)	0,01 to 0,47 μ F
Capacitance tolerance	<u>+20%</u> , <u>+10%</u>
Rated voltage U _{Rac} , 50 to 60 Hz	250V
Climatic category	40/085/21
Application class according to DIN 40040	GPF
Rated temperature	85°C
Related specification	IEC 384-14
Qualified according to	VDE 565-1, FI, SEV 1055.1978
Performance class	X2

Interference suppression capacitors

2222 331

SURVEY OF STYLES

	style	terminal pitch	table
	2222 331 5....	15 mm	1

	2222 331 5....	22,5 and 27,5mm	2

CONSTRUCTION

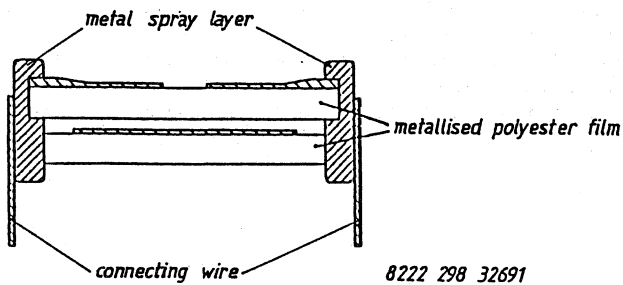

Interference suppression capacitors

2222 331

APPLICATION

For radio interference suppression in :

- small household appliances, e.g. coffee grinders, mixers,
- Since all metallized plastic film capacitors have always intrinsically active flammability risk, it is recommended to use these capacitors only in these cases where the capacitor is not continuously connected to the line.

DESCRIPTION

The capacitors consist of a series constructed, low-inductive wound cell of metallized polyethyleneterephthalate (PETP) film. The cell is potted with blue epoxy resin in a blue flame retardent polypropylene case. The radial leads are of a solder-coated wire. The capacitors can withstand solvents and rinsing liquids without damage.

They are provided with small stand-off pips to allow removal of solder flux etc., during cleaning, of the printed-wiring board.

1. GENERAL DATA

1.1. Mounting

Normal use

The capacitors are designed for printed wiring applications.

The capacitors packed on bandoliers are designed for mounting on printed-wiring boards by means of automatic insertion machines.

Specific method of mounting to withstand vibration and shock

In order to withstand vibration and shock tests, it must be ensured that the stand-off pips are in good contact with the printed-wiring board. For case sizes up to and including a mass of 6g. the capacitors shall be mechanically fixed by the leads.

With larger case sizes the capacitors shall be mounted in the same way and the body shall be clamped.

For capacitors with insulated leads the body shall be clamped.

Interference suppression capacitors

2222 331

1.2.1 Dimensions in mm.

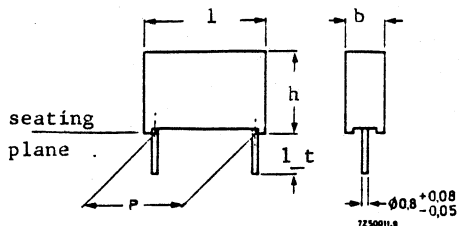

Fig. 1

Table 1

Style : 2222 331 5....
 Qualified according to : VDE 565-1
 FI, SEV 1055.1978

capacitance	b_max	h_max	l_max	P	mass	catalogue number 2222 331					
						loose in box Fig. 1				taped on reel Fig. 3	
						l_t = 5+ 1		l_t = 25 + 2			
						C-tol +20%	C-tol +10%	C-tol +20%	C-tol +10%	C-tol +20%	C-tol +10%
0,010	5	11	17,5			50103	51103	54103	55103	52103	53103
0,015	5	11	17,5		1,2	50153	51153	54153	55153	52153	53153
0,022	5	11	17,5			50223	51223	54223	55223	52223	53223
0,033	6	12	17,5	15+0,4	1,4	50333	51333	54333	55333	52333	53333
0,047	7	13,5	17,5		2	50473	51473	54473	55473	52473	53473
0,068	8,5	15	17,5		2,6	50683	51683	54683	55683	52683	53683

Interference suppression capacitors

2222 331

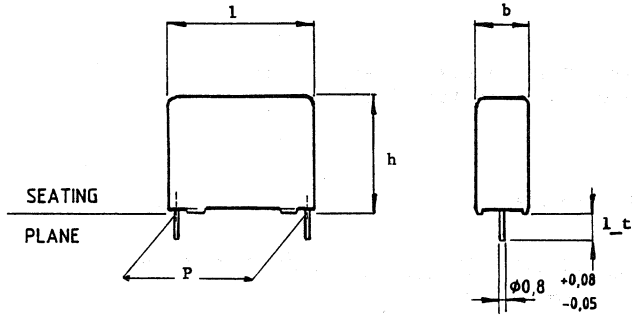

Fig. 2

Table 2

Style : 2222 331 5....
 Qualified according to : VDE 565-1
 FI, SEV 1055.1978

capacitance	b_max	h_max	l_max	P	mass	catalogue number 2222 331					
						loose in box Fig. 2				taped on reel Fig. 4	
						l_t = 5 + 1		l_t = 25 + 2		C-tol +20%	C-tol +10%
μF					g						
0,10	7	16,5	26	22,5	3,0	50104	51104	54104	55104	52104	53104
0,15	8,5	18	26	+0,4	3,7	50154	51154	54154	55154	52154	53154
0,22	10	19,5	26		5,4	50224	51224	54224	55224	52224	53224
0,33	11	21	31	27,5	13,7	50334	51334	54334	55334	52334	53334
0,47	13	23	31	+0,4	15	50474	51474	54474	55474	52474	53474

Interference suppression capacitors

2222 331

1.2.2 Packing

The capacitors are supplied loose in box or taped on reel, details of quantities are given in Tables 3 to 5.

Loose in box

Table 3 : Number of capacitors per box.

$\underline{l}_{\text{max}}$ mm	$\underline{b}_{\text{max}}$ mm	Number of capacitors per box			
		$\underline{l}_t = 5 + 1\text{mm}$		$\underline{l}_t = 25 + 2\text{mm}$	
		SPQ	PQ	SPQ	PQ
17,5	$\begin{matrix} < 6 \\ \geq 7 \end{matrix}$	1000	4000	$\begin{matrix} 1000 \\ 500 \end{matrix}$	$\begin{matrix} 4000 \\ 2000 \end{matrix}$
26		200	1000	500	500
31		100	500	125	500

Interference suppression capacitors

2222 331

Reel packing

1. Dimensions of taped products

Capacitors with pitch $P = 15\text{mm}$, Fig. 3.

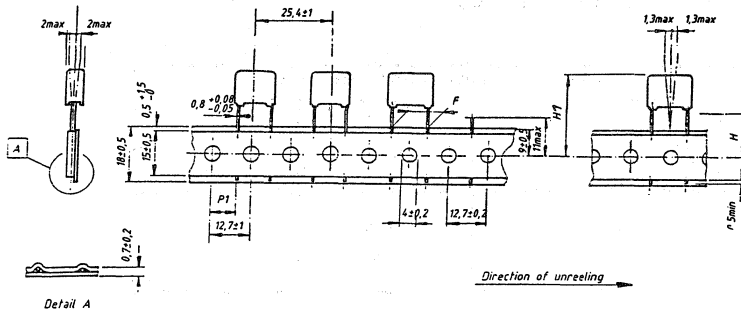

FOR PHYSICAL DIMENSIONS SEE PRODUCT SPECIFICATION

ITEM	SYMBOL	VALUE	VALUE	TOLERANCE
Lead to lead distance	F	10	15	+0.5/-0.1
Height of comp. from tape center to seating plane	H		18,5	±0.5
Component height from tape center	H1	max 32	max 35	for h = 18,5
Feed hole to leadcenter	P1	7,7	5,2	±0,7

Capacitors with pitch $P = 22,5$ or $27,5\text{mm}$, Fig. 4.

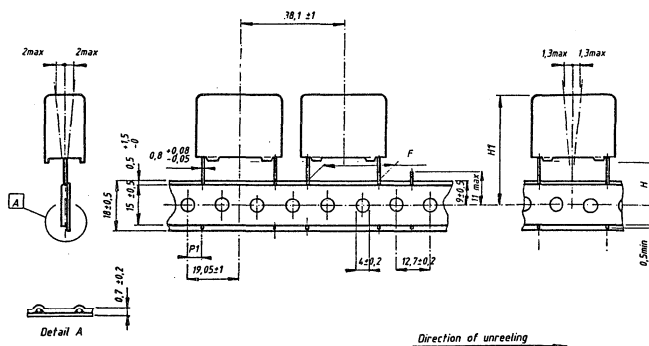

FOR PHYSICAL DIMENSIONS SEE PRODUCT SPECIFICATION

ITEM	SYMBOL	VALUE	VALUE	TOLERANCE
Lead to lead distance	F	22,5	27,5	+0.5/-0.1
Height of component from tape center to seating plane	H		18,5	±0.5
Component height from tape center	H1	max 40	max 48	for h=18,5
Feed hole to lead center	P1	7,8	5,33	±0,7

Interference suppression capacitors

2222 331

2. Characteristics of taped products

Pull-out force of the component	>5N
Pull-off force of the adhesive tape	>6N
Tearing force of tape	>15N
Storage conditions	
storage temperature	-25°C to +40°C
relative humidity	RH max. 80% without condensation

3. Outlines of reel packing

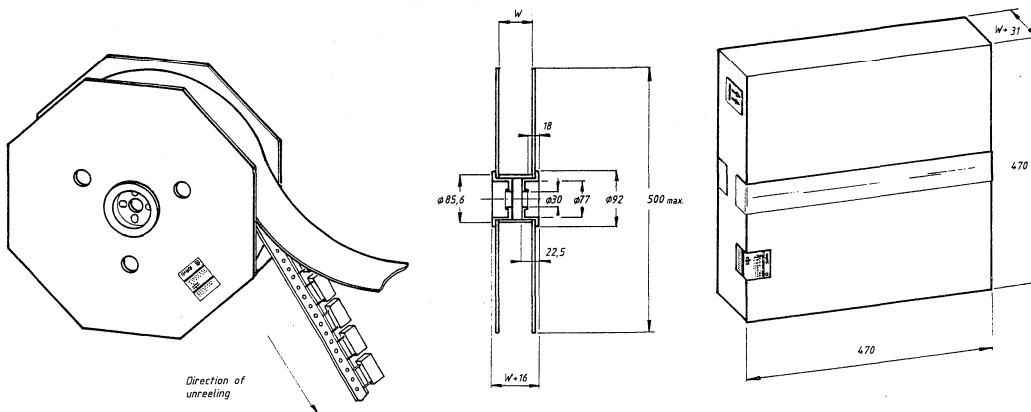

Fig. 5

Interference suppression capacitors

2222 331

4. Number of capacitors per reelTable 4 : l_{\max} 17,5mm

b_{\max} mm	Number per reel	$W + 2\text{mm}$
5	1100	45
6	900	45
7	800	45
8,5	650	50

Table 5 : l_{\max} 26 or 31mm

b_{\max} mm	Number per reel	$W + 2\text{mm}$
7	550	50
8,5	450	50
11	300	55
13	250	55

The max. number of empty places per reel shall not exceed 0,5% of the total number of components per reel, but a max. of 2 consecutive components may be missing provided this gap is followed by 6 consecutive components.

1.3 Ratings and characteristics

Unless otherwise specified all electrical values apply to an ambient free air temperature of 23 +1 °C, an atmospheric pressure of 86 to 106 kPa and a relative humidity of 50 +2%.

1.3.1 Capacitance

Capacitance range at 1 kHz see Table 1 and 2

Capacitance tolerance see Table 1 and 2

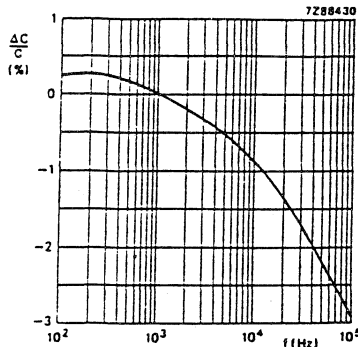

Fig. 6 : Capacitance as a function of frequency, typical curve.

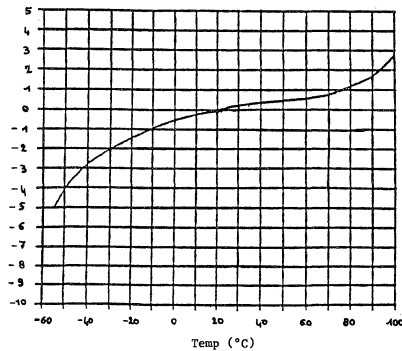

Fig. 7 : Capacitance as a function of ambient free air temperature, typical curve.

Interference suppression capacitors

2222 331**1.3.2 Voltage**

Rated voltage U_{Rac} (r.m.s. value),
50 to 60 Hz 250V

Test voltage
between terminations 1075V (d.c.)
between interconnected terminations
and case(foil method) 2000V (a.c.)

1.3.3 Climatic category
----- 40/085/21

1.3.4 Rated temperature
----- 85°C

1.3.5 Storage temperature range

Temperature
-25°C to +85°C
RH max. 80% without
condensation.

Interference suppression capacitors

2222 331

1.3.6 Tangent of loss angle

capacitance	tangent of loss angle		
	1kHz	10kHz	100kHz
$C \leq 100 \text{ nF}$	$\leq 75 \times 10^{-4}$	$\leq 130 \times 10^{-4}$	$\leq 250 \times 10^{-4}$
$0,1 < C \leq 0,47 \mu\text{F}$	$\leq 75 \times 10^{-4}$	$\leq 130 \times 10^{-4}$	$\leq 300 \times 10^{-4}$

1.3.7 Rated voltage pulse slope

Maximum pulse load (V/ μs)

l= 17,5 mm	l= 26 mm	l= 31 mm
200	120	100

Resonant frequency

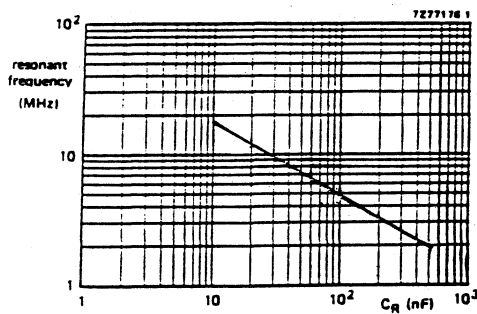

Fig. 8 Resonant frequency as a function of rated capacitance.

Interference suppression capacitors

2222 331

1.3.8 Insulation resistance at $T_{amb} 20^{\circ}\text{C}$

The insulation resistance is measured after a voltage of $100\text{V} \pm 15\text{V}$ has been applied for $1 \text{ min.} \pm 5 \text{ s}$.

R between terminations, for $C \leq 0,33\mu\text{F}$ $> 30\,000 \text{ M}\Omega$

$C > 0,33\mu\text{F}$ $> 10\,000 \text{ s}$

R between interconnected terminations and case (foil method) $> 30\,000 \text{ M}\Omega$

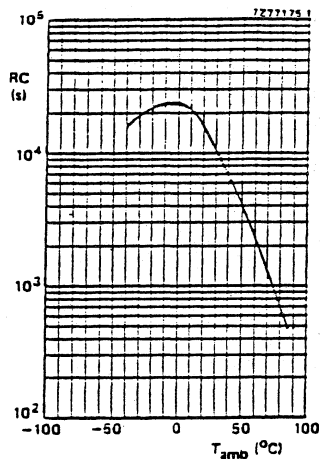

Fig. 9 : RC-product as a function of ambient free air temperature; typical curve.

Interference suppression capacitors

2222 331

1.4 Related documents :



Generic specification IEC 384-1
 Sectional specification IEC 384-14

1.5 Marking :

The capacitors with l_{max} 17,5 are marked on the top by embossed print, capacitors with l_{max} 26 or 31 are marked on the top by laser print.

with the following information :

- ° Capacitance n : nF
- ° Rated voltage (250 V \sim)
- ° Capacitance tolerance M : 20% K : 10%
- ° Manufacturer's type designation (e.g. 331 5)
- ° Code for dielectric material (MKT/MKT)
- ° Production date code acc. to IEC-62, clause 5 for cap. with l_{max} 17,5mm
 Year and week of manufacture (e.g. 9010) for cap. with l_{max} 26 or 31mm
- ° Manufacturer's name (PHILIPS)
- ° Code for factory of origin (HQ)
- ° Capacitor class and subclass (X2)
- ° Approval marks of National Testing Stations (e.g. FI)
- ° Climatic category (40/085/21)

Examples : 150n M 250V \sim X2  
 331 5 MKT/MKT 565-1  PZ1
 PHILIPS HQ 9010 40/085/21 1055

Interference suppression capacitors

2222 331

The package containing the capacitors is marked as follows

Data on label of SPQ and PQ
(example)

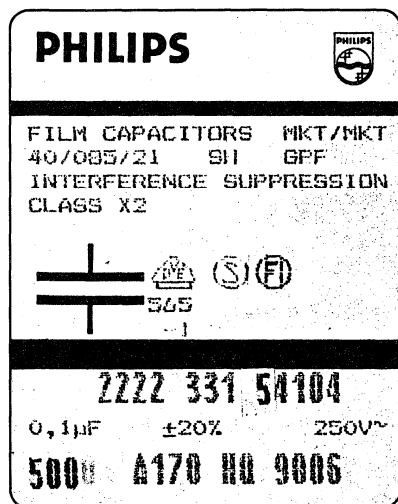

Block A : Philips word mark and emblem

Block B : Line 1 : Film capacitors and material code

Line 2 : Climatic category

Line 3 : Interference suppression capacitors

Line 4 : Class X2

Line 5 : Approbation symbols

Capacitor symbol

Block C : Line 1 : Produkt code (12NC)

Line 2 : Cap. value in μF

followed by μF

Tolerance followed by \pm and %

Voltage followed by V

Line 3 : Number of capacitors

Preference-origin code : A

Country of origin : Belgium=170

Responsible production centre :

Philips Roeselare = HQ

Production period : year- and

week code (4 digits)

1.6 Ordering information

Order the capacitors by quoting the 12-digit catalogue number as shown in Table 1 and 2

1.7 Certified test records (CTR)

Not required

Interference suppression capacitors

2222 331

2. INSPECTION REQUIREMENTS

Note 1 : Sub-clause numbers of tests and performance requirements refer to the Sectional Specification, IEC-publication 384-14 and Section One of this specification.

Note 2 : Inspection levels and AQL's are selected from IEC-Publication 410 : Sampling Plans and Procedures for Inspection by attributes.

Note 3 : In this table :

- p = periodicity (in months)
- n = sample size
- c = acceptance criterion (permitted number of defectives)
- D = destructive
- ND = non-destructive
- IL = inspection level) IEC 410
- AQL = acceptable quality level)

Note 4 : For this capacitor, considered as a solid construction, it is permitted to reduce the periodicity of the vibration and shock test from 6 months to 36 months.
In the event of a single defective occurring in subgroup Clb at this reduced rate of testing, then the vibration and shock tests shall revert to a 6 monthly periodicity until three successive 6-monthly tests shall have produced no defectives.

Interference suppression capacitors

2222 331

Clause number and Test (see Note 1)	D or ND	Conditions of Test (see Note 1)	IL (see Note 2)	AQL	Performance requirements (see Note 1)
<u>Group A Inspection (lot-by-lot)</u>					
<u>Sub-group A1</u>					
4.1 Visual examination	ND		I	2,5%	No mechanical failures Legible marking and as specified in GENERAL DATA of this specifi- cation.
4.2 Dimensions		Gauging			As specified in Tables of this specification
<u>Sub-group A2</u>					
4.2.2 Capacitance	ND	at 1kHz	II	1%	Within specified tolerance
4.2.3 Tangent of loss angle		at 100kHz			As in GENERAL DATA of this specification
4.2.1 Voltage proof (Test A)		at 1075V(d.c.) for 1 s.			No breakdown or flashover
4.2.4 Insulation resistance (Test A)		at 100V			As in GENERAL DATA of this specification

Interference suppression capacitors

2222 331

Sub-clause number and Test (see Note 1)	D or ND	Conditions of test (see Note 1)	Sample size + criterion of accepta- bility (see Note 3)			Performance requirements
			p	n	c	
<hr/>						
<u>Group C inspection</u> (periodic)						
<u>Sub-group CIA</u>	D		6	9	1	
Part of sample of Sub-group CI						
4.1 Dimensions (detail)						As specified in Tables of this specification
4.3.1 Initial measurements		Capacitance Tangent of loss angle at 100kHz				
4.3 Robustness of terminations		Tensile and bending				No visible damage
4.4 Resistance to soldering heat		Method : 1A Solder bath : 260°C Duration : 10 s				
4.14 Component solvent resistance		Mixture 1,1,2- trichlorotrifluoro- ethane and 2- propanol (isopro- pyl alcohol) Temperature 48,6° to 50,5°C (boiling) Method : 2 Immersion time : 5 ± 0,5 min. Recovery time : min. 1h max. 2h				
4.4.2 Final measurements		Visual examination Capacitance Tangent of loss angle				No visible damage Legible marking $\frac{\Delta C}{C} < 2\%$ of the va- lue measured initially Increase of $\tan \delta$ $< 0,005 C < 100nF$ $< 0,010 0,1 < C < 0,47\mu F$ compared to values measured in 4.3.1

Interference suppression capacitors

2222 331

Sub-clause number and Test (see Note 1)	D or ND	Conditions of test (see Note 1)	Sample size + criterion of accepta- bility (see Note 3)			Performance requirements
			p	n	c	
<u>Sub-group C1B</u> Other part of sample of Sub-group C1 4.6.1 Initial measurements	D	Capacitance Tangent of loss angle at 100kHz	6	18	1	
4.6 Rapid change of temperature		θA =lower cat. temp. θB =upper cat. temp. 5 cycles Duration t = 30min. Visual examination				No visible damage
4.7 Vibration (see Note 4)		Method of mounting see GENERAL DATA of this specification. Procedure B4. Frequency range : 10Hz to 5Hz. Amplitude 0,75mm or acceleration $98m/s^2$ (whichever is the less severe) Total duration 6h				
4.7.2 Final inspection		Visual examination				No visible damage
4.9 Shock (see Note 4)		Method of mounting see GENERAL DATA of this specification Pulse shape : half sine. Accelerat.: $490m/s^2$ Duration of pulse : 11ms				
4.9.3 Final measurements		Visual examination Capacitance Tangent of loss angle Insulation resistance				No visible damage $\Delta C < 3\%$ of the C value measured in 4.6.1 Increase of tan delta $< 0,005$ C $< 100nF$ $< 0,010$ 0,1 C $< 0,47\mu F$ compared to values measured in 4.6.1 As in GENERAL DATA of this speci- fication

Interference suppression capacitors

2222 331

Sub-clause number and Test (see Note 1)	D or ND	Conditions of test (see Note 2)	Sample size + criterion of accepta- bility (see Note 3)			Performance requirements
			p	n	c	
<u>Sub-group C1</u>	D		6	27	2	
Combined sample of spe- cimens of Sub-groups C1A and C1B						
4.10 Climatic sequence						
4.10.2 Dry heat		Temperature : upper category temperature Duration : 16h				
4.10.3 Damp heat cyclic, Test Db, first cycle						
4.10.4 Cold		Temperature : lower category temper. Duration : 2h				
4.10.6 Damp heat cyclic, Test Db remaining cycle						
4.10.6.2 Final measurements		Visual examination Capacitance Tangent of loss angle Insulation resistance Voltage proof 710V(d.c.), 1 min.				No visible damage Legible marking $\Delta \frac{C}{C} < 3\%$ of value measured in 4.4.2. or 4.9.3. Increase of $\tan \delta$ $< 0,005 \frac{C}{C}$ $< 100nF$ $< 0,010 \frac{C}{C}$ $0,1 < C < 0,47\mu F$ compared to values measured in 4.3.1 or 4.6.1 >50% of values in GENERAL DATA of this specification No breakdown or flashover.

Interference suppression capacitors

2222 331

Sub-clause number and Test (see Note 1)	D or ND	Conditions of test (see Note 1)	Sample size + criterion of accepta- bility (see Note 3)			Performance requirements
			p	n	c	
<u>Sub-group C2</u>	D		6	15	1	
4.11 Damp heat steady state		21 days, 40°C 90 - 95% R.H.				
4.11.1 Initial measurements		Capacitance Tangent of loss angle at 100kHz				
4.11.3 Final measurements		Visual examination Capacitance Tangent of loss angle Insulation resistance Voltage proof 710V(d.c.), 1 min.				No visible damage Legible marking $\Delta C < 3\%$ of the \bar{C} value measu- red in 4.11.1 Increase of $\tan \delta$ $< 0,005 \bar{C} < 100 \text{ nF}$ $< 0,010 \bar{C}, 1 < \bar{C} < 0,47 \mu\text{F}$ compared to values measured in 4.11.1 >50% of values in GENERAL DATA of this specification No breakdown or flashover.
<u>Sub-group C3</u>	D		3	21	1	
4.12 Endurance		Duration : 1000 h 1,25U _{Rac} at 85°C Once in each hour the voltage is in- creased to 1000V (r.m.s.) for 0,1s. via a resistor of 220Ω ± 10%				
4.12.1 Initial measurements		Capacitance Tangent of loss angle at 100kHz				

Interference suppression capacitors

2222 331

Sub-clause number and Test (see Note 1)	D or ND	Conditions of test (see Note 1)	Sample size + criterion of accepta- bility (see Note 3)			Performance requirements
			p	n	c	
4.12.5 Final measurements		Visual examination Capacitance Tangent of loss angle Insulation resistance Voltage proof 710V(d.c.), 1 min.				No visible damage Legible marking $\frac{\Delta C}{C} < 10\%$ of value measured in 4.12.1 Increase of $\tan \delta$ $< 0,005$ $C < 100$ nF $< 0,010$ $0,1 < C < 0,47$ μ F compared to values measured in 4.12.1 >50% of values in GENERAL DATA of this specification No breakdown or flashover.
<u>Sub-group C4</u>	D		3	9	1	
4.13 Charge and discharge		10 000cycles(50c/s) charge to U_R half sinus wave Duration : 5 ms discharge $R =$ $\frac{U_R}{C \cdot 1,5} \frac{\sqrt{2}}{dt}$ with a min.R of 2,2 Ω				
4.13.1 Initial measurements		Capacitance Tangent of loss angle at 100kHz				
4.13.3 Final measurements		Capacitance Tangent of loss angle Insulation resistance				$\frac{\Delta C}{C} < 3\%$ of value measured in 4.13.1 Increase of $\tan \delta$ $< 0,005$ $C < 100$ nF $< 0,010$ $0,1 < C < 0,47$ μ F >50% of values in GENERAL DATA of this specification

Interference suppression capacitors

2222 331

Additional tests	D or ND	Conditions of test	Sample size + criterion of accepta- bility			Performance requirements
			p	n	c	
<hr/>						
<u>Sub-group ADD1</u> A.1 Solderability	D	Without ageing Method : 1 Non-activated colo- phany flux 501 Solder bath 235°C Dwell time : 2 s.	3	35	1	Good tinning as evidenced by free flowing of the solder with wet- ting of the ter- minations (>95%)
Solvent resistance of the marking		Mixture 1,1,2- trichlorotrifluoro- ethane and 2- propanol (isopropylalcohol) Temperature : 48,6° to 50,5° C (boiling) Method 1 Rubbing material : cotton wool Immersion time : 5 ± 0,5 min.				
<hr/>						
<u>Sub-group ADD2</u> A.2 Heat storage	D	Duration : 1000h Temperature : upper category temperature	3	12	1	
A.2.1 Initial measurements		Capacitance Tangent of loss angle at 100kHz				
A.2.2 Final measurements		Capacitance Tangent of loss angle Insulation resistance				$\Delta \frac{C}{C} < 5\%$ of value measured in A.2.1 Increase of $\tan \delta$ $< 0,005 C < 100nF$ $< 0,010 0,1 < C < 0,47\mu F$ compared to values measured in A.2.1 As in GENERAL DATA of this specifi- cation.

Interference suppression capacitors

2222 331

Additional tests	D or ND	Conditions of test	Sample size + criterion of accepta- bility			Performance requirements
			p	n	c	
Sub-group ADD3 A.3 Detergent resistance		Density 20g/l Dishwasher detergent Temperature 70°C during 3 min. Followed by rinsing in clear water for 1 min. Recovery time 1to2h	3	9	1	
A.3.1 Initial measurements		Capacitance Tangent of loss angle at 100kHz				
A.3.2 Final measurements		Capacitance Tangent of loss angle Insulation resistance				$\frac{\Delta C}{C} \leq 2\%$ of value measured in A.3.1 Increase of $\tan \delta$ $\leq 0,005$ $C < 100nF$ $\leq 0,010$ $0,1 < C < 0,47\mu F$ compared to values measured in A.3.1 $> 50\%$ of values in GENERAL DATA of this specification.

Interference suppression capacitors

2222 331

Additional tests	D or ND	Conditions of test	Sample size + criterion of accepta- bility			Performance requirements
			p	n	c	
<u>Sub-group ADD4</u>	D		6	15	1	
A.4 Resistance to soldering heat with pre-heating		Capacitors mounted on a 1,6mm board with nonplated holes Body temp. : 80°C Bath temp. : 260°C Dwell time : 2x5s				
A.4.1 Initial measurements		Capacitance Tangent of loss angle at 100kHz				
A.4.2 Final measurements		Capacitance Tangent of loss angle				$\frac{\Delta C}{C} < 2\%$ of value measured in A.4.1 Increase of tan d <0,005 C <100 nF <0,010 0,1 < C <0,47μF compared to values measured in A.4.1

Interference suppression capacitors

2222 331

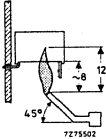
Additional tests	D or ND	Conditions of test	Sample size + criterion of accepta- bility			Performance requirements
			p	n	c	
<u>Sub-group ADD5</u>						
A.5.1.Needle flame test IEC 40 (secr.)580 Class C		Bore of gas jet : $\varnothing 0,5\text{MM}$ Fuel : butane test duration actual volume (mm^3) : $< 250 : 5\text{s}$ $250 < V < 500 = 10\text{s}$ $500 < V < 1750 = 20\text{s}$ $V > 1750 = 30\text{s}$ One flame applica- tion.				After removing the test flame from the capacitor, the ca- pacitor must not continue to burn for more than 30s no burning parts must drop from the sample
		 <p style="text-align: center;">7275502</p>				

AC and pulse

Philips Components

Data sheet	
status	Product specification
date of issue	May 1990

2222 376

AC and pulse metallized polypropylene film capacitors

KP/MMKP Radial potted type

- ° 15 to 27,5 mm terminal pitch
- ° Supplied loose in box and taped on reel

QUICK REFERENCE DATA

Capacitance range (E24-series)	0,001 to 0,27 μ F
Capacitance tolerance	<u>+10%</u> , <u>+5%</u> , <u>+ 3,5%</u>
Rated voltage (d.c.)	630V, 1000V, 1600V, 2000V
Rated voltage (a.c.)	300V, 400V, 500V, 600V
Climatic category	55/100/56
Rated temperature	85°C
Related specification	IEC 384-17
Performance grade	for C > 4,7 nF Grade 1 (long life) for C <u>≤</u> 4,7 nF Grade 2 (general purpose)
Stability grade	Grade 2

AC and pulse metallized polypropylene film capacitors

2222 376

SURVEY OF STYLES

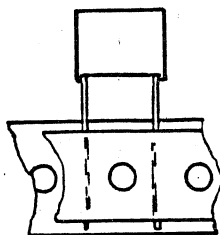

Style 2222 376
Terminal pitch : 15mm
See Tables 1 to 4

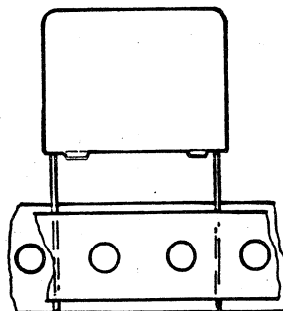
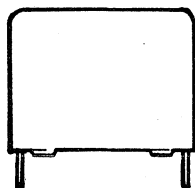

Style 2222 376
Terminal pitch : 22,5mm and 27,5mm

CONSTRUCTION

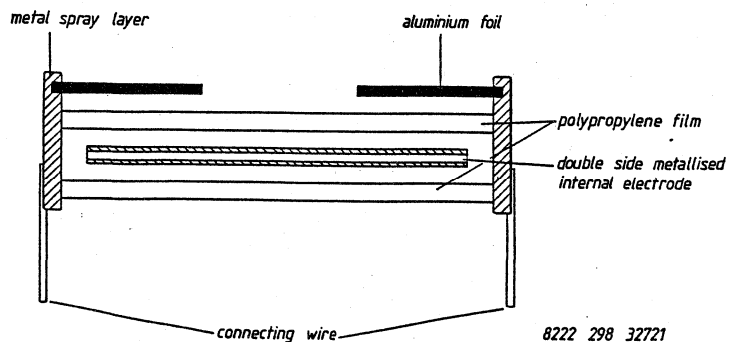

AC and pulse metallized polypropylene film capacitors

2222 376

APPLICATION

For applications where high currents and steep pulses occur. They are mainly used for deflection circuits in television receivers, for operation at high peak currents at line frequency. When requiring advice, please send oscillograms of current and voltage waveforms.

DESCRIPTION

The capacitors consist of a series-constructed, low-inductive wound cell of polypropylene film, aluminium foil and metallized internal electrode. The cell is potted with blue epoxy resin in a blue flame retardent polypropylene case. The radial leads are of solder-coated wire. The capacitors can withstand solvents and rinsing liquids without damage. They are provided with small stand-off pips to allow removal of solder flux etc., during cleaning of the printed-wiring board.

1. GENERAL DATA**1.1. Mounting****Normal use**

The capacitors are designed for printed wiring applications.

The capacitors packed in bandoliers are designed for mounting on printed-wiring boards by means of automatic insertion machines.

Specific method of mounting to withstand vibration and shock

In order to withstand vibration and shock tests, it must be insured that the stand-off pips are in good contact with the printed-wiring board.

For case sizes up to and including a mass of 6 g the capacitors shall be mechanically fixed by the leads.

With larger case sizes the capacitors shall be mounted in the same way and the body shall be clamped.

AC and pulse metallized polypropylene film capacitors

2222 376

1.2.1 Dimensions in mm

Fig. 1

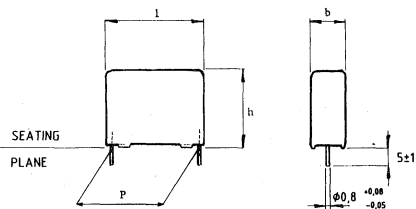

Table 1 U_{Rdc} = 630V; rated a.c. voltage = 300V

capacitance μF	b _{max}	h _{max}	l _{max}	P	mass g	catalogue number 2222 376								
						loose		in box		Fig.1-2		taped on reel		Fig.2-3
						C-tol + 10%	C-tol + 5 %	C-tol + 3,5%	C-tol + 10%	C-tol + 5 %	C-tol + 3,5%			
0,0068	5	11			1,1	61682	62682	63682	64682	65682	66682			
0,0075	5	11			1,1	61752	62752	63752	64752	65752	66752			
0,0082	5	11			1,1	61822	62822	63822	64822	65822	66822			
0,0091	5	11			1,1	61912	62912	63912	64912	65912	66912			
0,010	6	12			1,4	61103	62103	63103	64103	65103	66103			
0,011	6	12			1,4	61113	62113	63113	64113	65113	66113			
0,012	6	12	17,5	15±0,3	1,4	61123	62123	63123	64123	65123	66123			
0,013	6	12			1,4	61133	62133	63133	64133	65133	66133			
0,015	7	13			1,8	61153	62153	63153	64153	65153	66153			
0,016	7	13			1,8	61163	62163	63163	64163	65163	66163			
0,018	7	13			1,8	61183	62183	63183	64183	65183	66183			
0,020	8,5	14,5			2,6	61203	62203	63203	64203	65203	66203			
0,022	8,5	14,5			2,6	61223	62223	63223	64223	65223	66223			
0,024	6	15,5			2,8	61243	62243	63243	64243	65243	66243			
0,027	6	15,5			2,8	61273	62273	63273	64273	65273	66273			
0,030	6	15,5			3,5	61303	62303	63303	64303	65303	66303			
0,033	7	16,5			3,5	61333	62333	63333	64333	65333	66333			
0,036	7	16,5			3,5	61363	62363	63363	64363	65363	66363			
0,039	7	16,5	26	22,5 ± 0,3	3,5	61393	62393	63393	64393	65393	66393			
0,043	8,5	18			4,4	61433	62433	63433	64433	65433	66433			
0,047	8,5	18			4,4	61473	62473	63473	64473	65473	66473			
0,051	8,5	18			4,4	61513	62513	63513	64513	65153	66153			
0,056	8,5	18			5,1	61563	62563	63563	64563	65563	66563			
0,062	9	19			7,4	61623	62623	63623	64623	65623	66623			
0,068	9	19			7,4	61683	62683	63683	64683	65683	66683			
0,075	9	19			7,4	61753	62753	63753	64753	65753	66753			
0,082	11	21			7,4	61823	62823	63823	64823	65823	66823			
0,091	11	21			7,4	61913	62913	63913	64913	65913	66913			
0,10	11	21			7,4	61104	62104	63104	64104	65104	66104			
0,11	11	21			7,4	61114	62114	63114	64114	65114	66114			
0,12	13	23	31	27,5 ± 0,3	10,2	61124	62124	63124	64124	65124	66124			
0,13	13	23			10,2	61134	62134	63134	64134	65134	66134			
0,15	13	23			10,2	61154	62154	63154	64154	65154	66154			
0,16	13	23			10,2	61164	62164	63164	64164	65164	66164			
0,18	15	25			12,8	61184	62184	63184	64184	65184	66184			
0,20	15	25			12,8	61204	62204	63204	64204	65204	66204			
0,22	18	28			18,2	61224	62224	63224	64224	65224	66224			
0,24	18	28			18,2	61244	62244	63244	64244	65244	66244			
0,27	18	28			18,2	61274	62274	63274	64274	65274	66274			

AC and pulse metallized polypropylene film capacitors

2222 376

Table 2 $U_{Rdc} = 1000V$; rated a.c. voltage = 400V

capacitance μF	b_max	h_max	l_max	P	mass g	catalogue number 2222 376			
						loose in box Fig.1		taped on reel Fig.2-3	
						C-tol $\pm 5\%$	C-tol $\pm 3,5\%$	C-tol $\pm 5\%$	C-tol $\pm 3,5\%$
0,0047	5	11			1,1	72472	73472	75472	76472
0,0051	5	11			1,1	72512	73512	75512	76512
0,0056	5	11			1,1	72562	73562	75562	76562
0,0062	6	12			1,4	72622	73622	75622	76622
0,0068	6	12			1,4	72682	73682	75682	76682
0,0075	6	12	17,5	$15 \pm 0,4$	1,4	72752	73752	75752	76752
0,0082	6	12			1,4	72822	73822	75822	76822
0,0091	7	13			1,8	72912	73912	75912	76912
0,010	7	13			1,8	72103	73103	75103	76103
0,011	7	13			1,8	72113	73113	75113	76113
0,012	8,5	14,5			2,6	72123	73123	75123	76123
0,013	6	15,5			2,8	72133	73133	75133	76133
0,015	7	16,5			2,8	72153	73153	75153	76153
0,016	7	16,5			2,8	72163	73163	75163	76163
0,018	7	16,5			3,5	72183	73183	75183	76183
0,020	8,5	18			3,5	72203	73203	75203	76203
0,022	8,5	18	26	$22,5 \pm 0,4$	4,4	72223	73223	75223	76223
0,024	8,5	18			4,4	72243	73243	75243	76243
0,027	8,5	18			4,4	72273	73273	75273	76273
0,030	8,5	18			4,4	72303	73303	75303	76303
0,033	8,5	18			4,4	72333	73333	75333	76333
0,036	8,5	18			4,4	72363	73363	75363	76363
0,039	10	19,5			5,1	72393	73393	75393	76393
0,043	9	19			7,4	72433	73433	75433	76433
0,047	9	19			7,4	72473	73473	75473	76473
0,051	9	19			7,4	72513	73513	75513	76513
0,056	11	21			7,4	72563	73563	75563	76563
0,062	11	21			7,4	72623	73623	75623	76623
0,068	11	21			7,4	72683	73683	75683	76683
0,075	11	21			7,4	72753	73753	75753	76753
0,082	13	23	31	$27,5 \pm 0,4$	10,2	72823	73823	75823	76823
0,091	13	23			10,2	72913	73913	75913	76913
0,10	13	23			10,2	72104	73104	75104	76104
0,11	15	25			12,8	72114	73114	75114	76114
0,12	15	25			12,8	72124	73124	75124	76124
0,13	15	25			12,8	72134	73134	75134	76134
0,15	15	25			12,8	72154	73154	75154	76154
0,16	18	28			18,2	72164	73164	75164	76164
0,18	18	28			18,2	72184	73184	75184	76184

AC and pulse metallized polypropylene film capacitors

2222 376

Table 3 $U_{Rdc} = 1600V$; rated a.c. voltage = 500V

capacitance μF	b_{max}	h_{max}	l_{max}	P	mass g	catalogue number 2222 376					
						loose	in box	Fig.1	taped	on reel	Fig.2-3
						C-tol + 10%	C-tol + 5%	C-tol + 3,5%	C-tol + 10%	C-tol + 5%	C-tol + 3,5%
0,0018	5	11			1,1	81182	82182	83182	84182	85182	86182
0,0020	6	12			1,4	81202	82202	83202	84202	85202	86202
0,0022	6	12			1,4	81222	82222	83222	84222	85222	86222
0,0024	6	12			1,4	81242	82242	83242	84242	85242	86242
0,0027	7	13			1,8	81272	82272	83272	84272	85272	86272
0,0030	7	13	17,5	$15 \pm 0,3$	1,8	81302	82302	83302	84302	85302	86302
0,0033	7	13			1,8	81332	82332	83332	84332	85332	86332
0,0036	8,5	14,5			2,6	81362	82362	83362	84362	85362	86362
0,0039	8,5	14,5			2,6	81392	82392	83392	84392	85392	86392
0,0043	8,5	14,5			2,6	81432	82432	83432	84432	85432	86432
0,0047	8,5	14,5			2,6	81472	82472	83472	84472	85472	86472
0,0051	6	15,5			2,8	81512	82512	83512	84512	85512	86512
0,0056	6	15,5			2,8	81562	82562	83562	84562	85562	86562
0,0062	6	15,5			2,8	81622	82622	83622	84622	85622	86622
0,0068	6	15,5			2,8	81682	82682	83682	84682	85682	86682
0,0075	7	16,5			2,8	81752	82752	83752	84752	85752	86752
0,0082	7	16,5			2,8	81822	82822	83822	84822	85822	86822
0,0091	7	16,5			3,5	81912	82912	83912	84912	85912	86912
0,010	8,5	18	26	$22,5 \pm 0,3$	3,5	81103	82103	83103	84103	85103	86103
0,011	8,5	18			4,4	81113	82113	83113	84113	85113	86113
0,012	8,5	18			4,4	81123	82123	83123	84123	85123	86123
0,013	8,5	18			5,1	81133	82133	83133	84133	85133	86133
0,015	10	19,5			5,1	81153	82153	83153	84153	85153	86153
0,016	9	19			7,4	81163	82163	83163	84163	85163	86163
0,018	11	21			7,4	81183	82183	83183	84183	85183	86183
0,020	11	21			7,4	81203	82203	83203	84203	85203	86203
0,022	11	21			7,4	81223	82223	83223	84223	85223	86223
0,024	11	21			7,4	81243	82243	83243	84243	85243	86243
0,027	13	23			10,2	81273	82273	83273	84273	85273	86273
0,030	13	23	31	$27,5 \pm 0,3$	10,2	81303	82303	83303	84303	85303	86303
0,033	13	23			10,2	81333	82333	83333	84333	85333	86333
0,036	13	23			10,2	81363	82363	83363	84363	85363	86363
0,039	15	25			12,8	81393	82393	83393	84393	85393	86393
0,043	15	25			12,8	81433	82433	83433	84433	85433	86433
0,047	18	28			18,2	81473	82473	83473	84473	85473	86473
0,051	18	28			18,2	81513	82513	83513	84513	85513	86513
0,056	18	28			18,2	81563	82563	83563	84563	85563	86563

AC and pulse metallized polypropylene film capacitors

2222 376

Table 4 U_{Rdc} = 2000V; rated a.c. voltage = 600V

capacitance μF	b _{max}	h _{max}	l _{max}	P	mass g	catalogue number 2222 376					
						loose in box		Fig.1	taped on reel		Fig.2-3
						C-tol + 5 %	C-tol + 3,5%	C-tol + 5 %	C-tol + 3,5%	C-tol + 5 %	C-tol + 3,5%
0,0010	5	11			1,1	92102	93102		95102	96102	
0,0011	5	11			1,1	92112	93112		95112	96112	
0,0012	6	12			1,4	92122	93122		95122	96122	
0,0013	6	12			1,4	92132	93132		95132	96132	
0,0015	6	12			1,4	92152	93152		95152	96152	
0,0016	6	12	17,5	15± 0,3	1,4	92162	93162		95162	96162	
0,0018	7	13			1,8	92182	93182		95182	96182	
0,0020	7	13			1,8	92202	93202		95202	96202	
0,0022	8,5	14,5			2,6	92222	93222		95222	96222	
0,0024	8,5	14,5			2,6	92242	93242		95242	96242	
0,0027	8,5	14,5			2,6	92272	93272		95272	96272	
0,0030	8,5	14,5			2,6	92302	93302		95302	96302	
0,0033	6	15,5			2,8	92332	93332		95332	96332	
0,0036	6	15,5			2,8	92362	93362		95362	96362	
0,0039	6	15,5			2,8	92392	93392		95392	96392	
0,0043	7	16,5			2,8	92432	93432		95432	96432	
0,0047	7	16,5			2,8	92472	93472		95472	96472	
0,0051	7	16,5	26	22,5 ± 0,3	3,5	92512	93512		95512	96512	
0,0056	8,5	18			3,5	92562	93562		95562	96562	
0,0062	8,5	18			3,5	92622	93622		95622	96622	
0,0068	8,5	18			3,5	92682	93682		95682	96682	
0,0075	8,5	18			4,4	92752	93752		95752	96752	
0,0082	8,5	18			4,4	92822	93822		95822	96822	
0,0091	10	19,5			5,1	92912	93912		95912	96912	
0,010	10	19,5			5,1	92103	93103		95103	96103	
0,011	11	21			7,4	92113	93113		95113	96113	
0,012	11	21			7,4	92123	93123		95123	96123	
0,013	11	21			7,4	92133	93133		95133	96133	
0,015	11	21			7,4	92153	93153		95153	96153	
0,016	13	23			10,2	92163	93163		95163	96163	
0,018	13	23	31	27,5 ± 0,3	10,2	92183	93183		95183	96183	
0,020	13	23			10,2	92203	93203		95203	96203	
0,022	13	23			10,2	92223	93223		95223	96223	
0,024	15	25			12,8	92243	93243		95243	96243	
0,027	15	25			12,8	92273	93273		95273	96273	
0,030	18	28			18,2	92303	93303		95303	96303	
0,033	18	28			18,2	92333	93333		95333	96333	

1.2.2 Packaging

The capacitors are supplied loose in box or taped on reel, details of quantities are given in Tables 5 to 7.

Loose in box

Table 5 : Number of capacitors per box.

\bar{l} max mm	\bar{b} max mm	Number of capacitors per box	
		SPQ	PQ
17,5	$\begin{matrix} < 6 \\ \sum 7 \end{matrix}$	1000	4000
26		200	1000
31		100	500

AC and pulse metallized polypropylene film capacitors

2222 376

Reel packing

1. Dimensions of taped products

Capacitors with pitch P = 15mm, Fig. 2

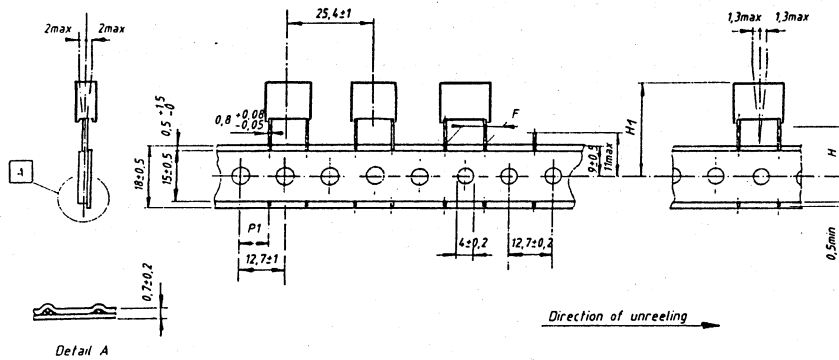

FOR PHYSICAL DIMENSIONS SEE PRODUCT SPECIFICATION

ITEM	SYMBOL	VALUE	VALUE	TOLERANCE
Lead to lead distance	F	10	15	+0,5/-0,1
Height of comp. from tape center to seating plane	H	18,5		±0,5
Component height from tape center	H1	max 32	max 35	for h1 = 18,5
Feed hole to leadcenter	P1	7,7	5,2	±0,7

Capacitors with pitch P = 22,5 or 27,5mm, Fig. 3

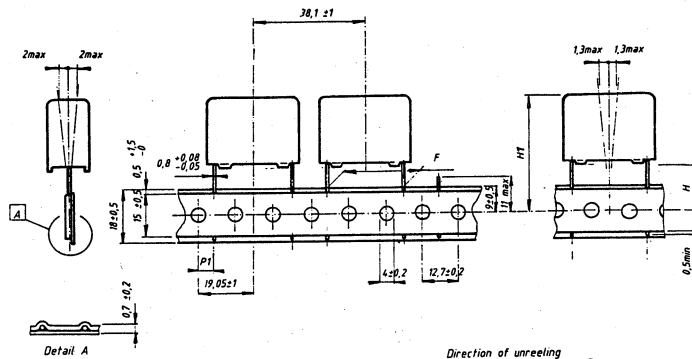

FOR PHYSICAL DIMENSIONS SEE PRODUCT SPECIFICATION

ITEM	SYMBOL	VALUE	VALUE	TOLERANCE
Lead to lead distance	F	22,5	27,5	+0,5/-0,1
Height of component from tape center to seating plane	H	18,5		±0,5
Component height from tape center	H1	max 40	max 48	for h1=18,5
Feed hole to lead center	P1	7,8	5,33	±0,7

AC and pulse metallized polypropylene film capacitors

2222 376

2. Characteristics of taped products

Pull-out force of the component	>5N
Pull-off force of the adhesive tape	>6N
Tearing force of tape	>15N
Storage conditions	
storage temperature	-25°C to +40°C
relative humidity	RH max. 80% without condensation

3. Outlines of reel packing

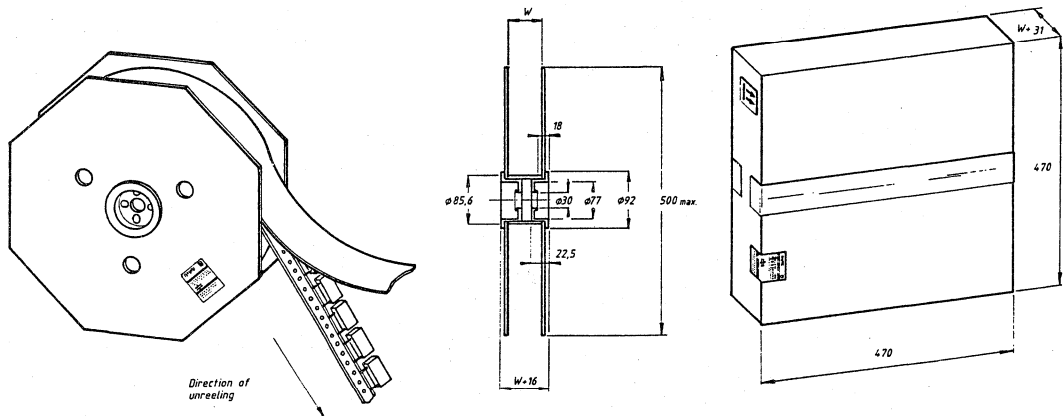

Fig. 4

AC and pulse metallized polypropylene film capacitors

2222 376

4. Number of capacitors per reelTable 6 : l_{\max} 17,5mm

b_{\max} mm	Number per reel	$W \pm 2$ mm
5	1100	45
6	900	45
7	800	45
8,5	650	50

Table 7 : l_{\max} 26 or 31mm

b_{\max} mm	Number per reel	$W \pm 2$ mm
6	600	50
7	550	50
8,5	450	50
9	400	50
10	350	50
11	300	55
13	250	55
15	200	60
18	150	60

The max. number of empty places per reel shall not exceed 0,5% of the total number of components per reel, but a max. of 2 consecutive components may be missing provided this gap is followed by 6 consecutive components.

1.3 Ratings and characteristics

Unless otherwise specified all electrical values apply to an ambient free air temperature of 23 \pm 1°C, an atmospheric pressure of 86 to 106 kPa and a relative humidity of 50 \pm 2%.

1.3.1 Capacitance

Capacitance range at 1 kHz see Tables 1 to 4

Capacitance tolerance see Tables 1 to 4

Frequency dependence between 100Hz and 100KHz : negligible.

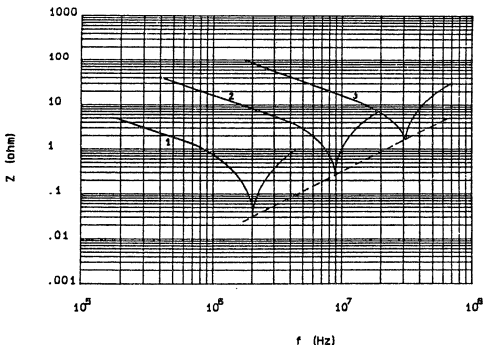

- 1 : 180nF - 1000V
- 2 : 10nF - 1600V
- 3 : 1nF - 2000V

Fig. 5 : Impedance as a function of frequency; typical curve.

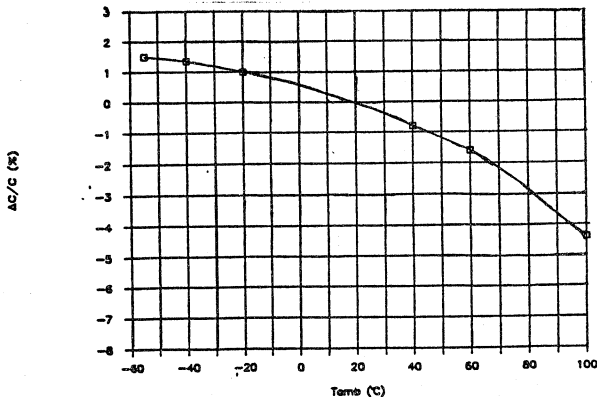

Fig. 6 : Capacitance as a function of ambient free air temperature; typical curve.

1.3.2 Voltage

Rated voltage U_{Rdc}	see Tables 1 to 4
Rated voltage U_{Rac} (r.m.s.)	see Tables 1 to 4
Category voltage U_C	$0,7 \times U_R$
Test voltage between terminations	$1,6 \times U_{Rdc}$
between interconnected terminations and case (foil method)	2840 Vdc

Maximum r.m.s. voltage as a function of frequency : see Fig. 7 to 10

Maximum r.m.s. voltage as a function of temperature :
The maximum r.m.s. voltage in Fig. 7 to 10 must be multiplied
by a factor depending of the ambient temperature. see Fig. below.

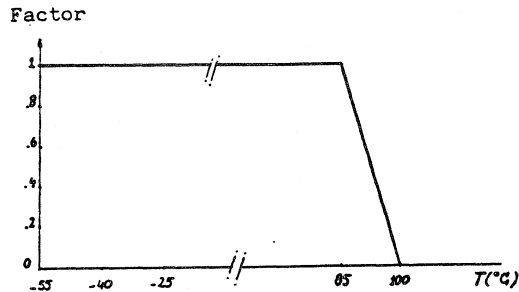

Multiplying factor as a function of temperature

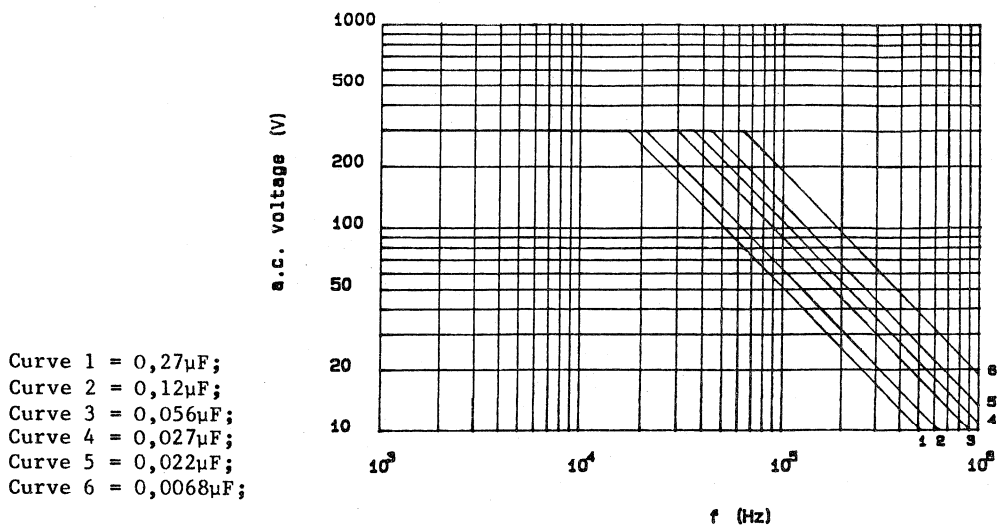

Fig. 7 a.c. voltage(r.m.s. value) as a function of frequency at $T_{amb} \leq 85^{\circ}C$
 for $U_{Rdc} = 630V$.

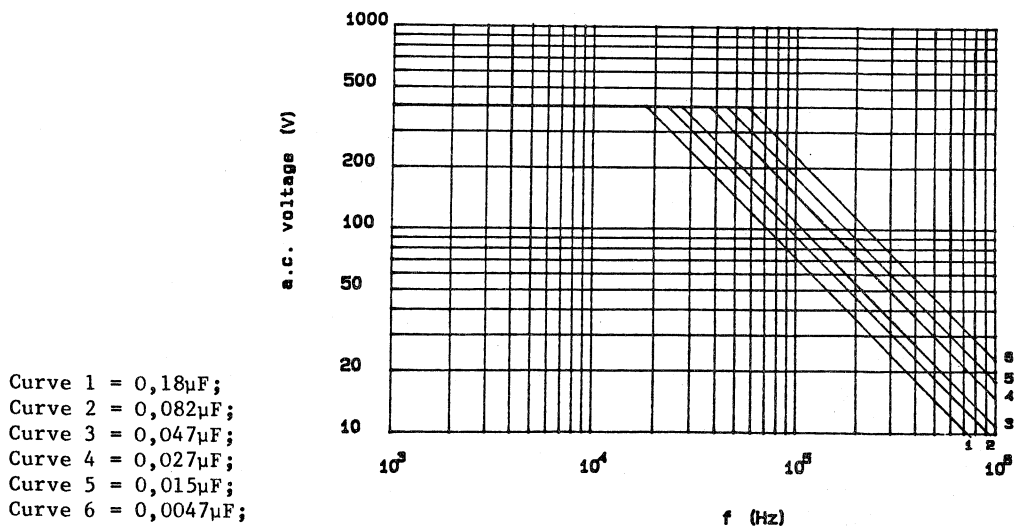

Fig. 8 a.c. voltage(r.m.s. value) as a function of frequency at $T_{amb} \leq 85^{\circ}C$,
 for $U_{Rdc} = 1000V$.

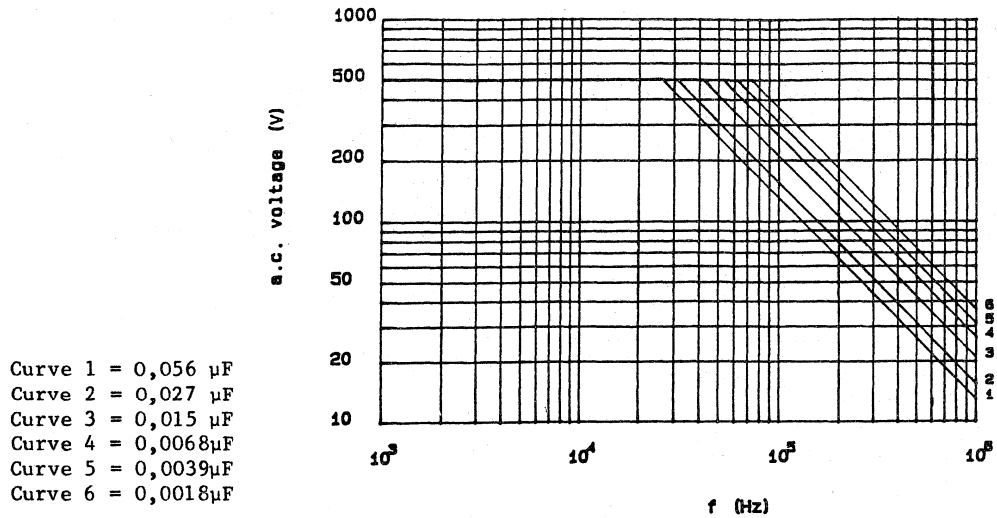

Fig.9 : a.c. voltage (r.m.s. value) as a function of frequency at
 $T_{\text{amb}} < 85^{\circ}\text{C}$ for $U_{\text{Rdc}} = 1600\text{V}$

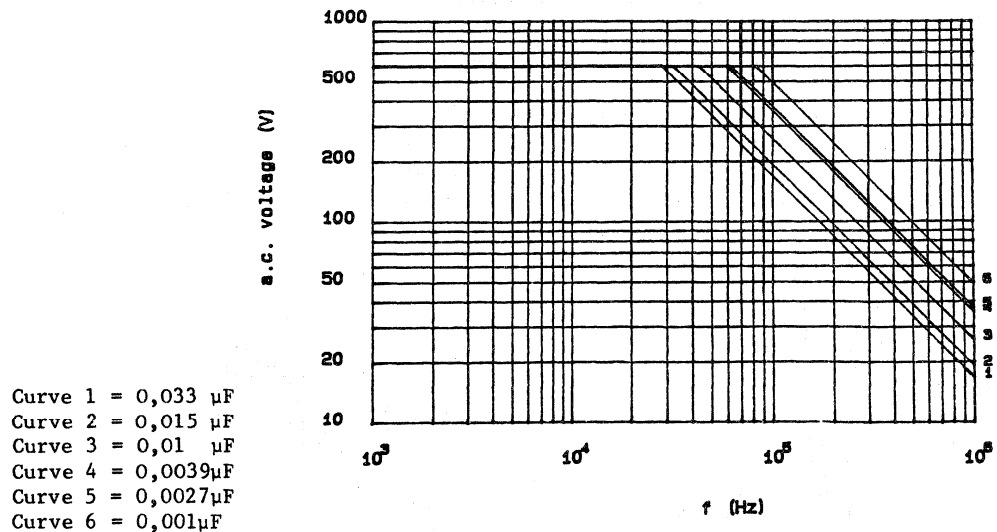

Fig. 10: a.c. voltage (r.m.s. value) as a function of frequency at
 $T_{\text{amb}} < 85^{\circ}\text{C}$ for $U_{\text{Rdc}} = 2000\text{V}$

AC and pulse metallized polypropylene film capacitors

2222 376

- 1.3.3 Climatic category 55/100/56
- 1.3.4 Rated temperature 85°C
 Temperature characteristics -55°C to +20°C $0 \leq \frac{\Delta C}{C} \leq 3,75\%$
 related to $20 \pm 2^\circ\text{C}$ 20°C to 100°C $-7\% \leq \frac{\Delta C}{C} \leq 0\%$
- 1.3.5 Storage temperature range Temperature -25 to +40°C
RH max. 80% without condensation.
- 1.3.6 Tangent of loss angle (maximum)

Rated dc voltage	at 10kHz ($\times 10^{-4}$)		
	l=17,5mm	l = 26mm	l = 31mm
630	3	3	4
1000	3	3	3
1600	3	3	3
2000	3	3	3

Rated dc voltage	at 100kHz ($\times 10^{-4}$)		
	l=17,5mm	l = 26mm	l = 31mm
630	10	15	20
1000	10	10	15
1600	10	10	15
2000	10	10	15

Fig.12 Tangent of loss angle (maximum value) as a function of frequency.

Curve 1 = 15 mm pitch, all series
 22,5 mm pitch, 1000V,
 1500V, 1600V series
 2000V series

Curve 2 = 22,5mm pitch
 630V series
 = 27,5mm pitch
 1000V series
 1500V, 1600V series
 2000V series

Curve 3 = 27,5mm pitch
 630V series

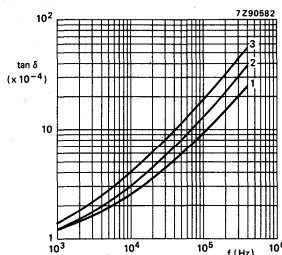

AC and pulse metallized polypropylene film capacitors

2222 376

1.3.7 Rated voltage pulse slope $(\frac{dU}{dt})_R$

 Limited by network conditions

1.3.8 Insulation resistance at $T_{amb} 20^\circ C$

 The insulation resistance is measured after a voltage of 500 ± 50 V has
 been applied for $1 \text{ min.} \pm 5 \text{ s.}$

R between terminations $> 100\ 000\ M\Omega$

R between interconnected terminations and case $> 100\ 000\ M\Omega$
 (foil method)

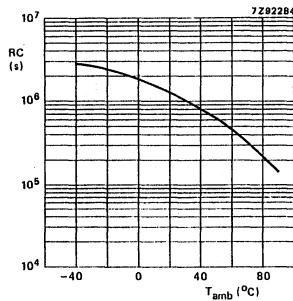
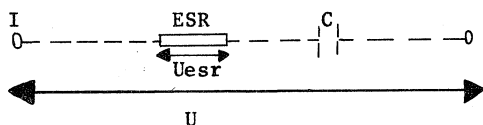

Fig. 12 RC product as a function of ambient free air temperature; typical curve.

1.3.9 Maximum dissipation

The power dissipated by a capacitor is a function of the voltage U_{esr} across or the current I through the series resistance ESR and is expressed by:

$$P = \frac{U_{esr}^2}{ESR} \quad (1) \quad \text{or } P = ESR \cdot I^2 \quad (2)$$



$$U_{esr}^2 = \frac{ESR^2}{ESR^2 + 1/w^2C^2} \cdot U^2 \quad (3a)$$

As for film capacitors $\tan_{\delta} = w.C.ESR \ll 0.1$, the formula (3a) can be simplified to

$$U_{esr}^2 = ESR^2 \cdot w^2 \cdot C^2 \cdot U^2 \quad (3b)$$

or with $ESR = \tan_{\delta}/wC$, we become:

$$P = w.C.\tan_{\delta}.U^2 \quad (4) \quad \text{or } P = \frac{\tan_{\delta}}{w.C} I^2 \quad (5)$$

For the \tan_{δ} we can take the value found from fig.11, C is in farad and $w = 2\pi.f$.

U or I are assumed to be known.

The maximum permissible power dissipation (P_{max}), which depends on the dimensions of the capacitor and on the ambient free air temperature can be found from fig.13.

In applications where sine waves occur, we have to take for U the RMS-voltage or for I the RMS-current of the sine wave.

In applications where periodic signals occur, the signal has to be expressed in Fourier-terms:

$$U = U_0 + \sum_{k=1}^{\infty} \frac{1}{k} \sin(kwt + \phi_k) \quad (6)$$

AC and pulse metallized polypropylene film capacitors

2222 376

$$I = \sum_{k=1}^{\infty} I_k \sin(k\omega t + \varphi_k) \quad (7)$$

with U_0 the D.C.voltage, U_k and I_k the voltage resp. of the k-th harmonic.

We become for the dissipated power :

$$\text{with (6)} \quad P = \sum_{k=1}^{\infty} k \cdot \omega \cdot C \cdot \tan_{\Delta} \delta_k \cdot \frac{U_k^2}{2} \quad (8)$$

$$\text{with (7)} \quad P = \sum_{k=1}^{\infty} \tan_{\Delta} \delta_k \cdot \frac{I_k^2}{k \cdot \omega \cdot C \cdot 2} \quad (9)$$

and $\tan_{\Delta} \delta_k$ is the $\tan_{\Delta} \delta$ at the k-th harmonic.

Curve	Dimensions (mm)		
	b_max	h_max	l_max
1	5	11	17,5
2	6	12	17,5
3	7	13	17,5
4	8,5	14,5	17,5
5	6	15,5	26
6	7	16,5	26
7	8,5	18	26
8	10	19,5	26
9	9	19	31
10	11	21	31
11	13	23	31
12	15	25	31
13	18	28	31

Pmax (mW) as a function of temperature

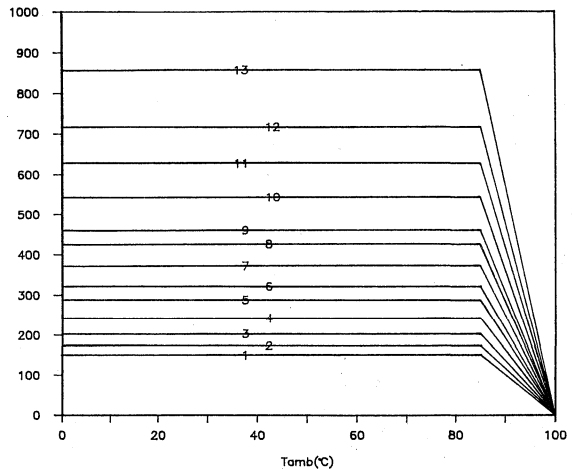

Fig.13 Maximum dissipation as a function of ambient free air temperature, at various capacitor dimensions.

1.3.10 Application note

To select this capacitor for a certain application you have to check 6 conditions :

1. The peak voltage (V_p) shall not be greater than the rated d.c. voltage.
2. The peak to peak voltage (V_{pp}) shall not be greater than $2\sqrt{2}$ times the rated a.c. voltage to avoid the ionisation inception level.
3. There is no limit for the peak current (I_p) or voltage pulse slope (dV/dt) in the application.
4. The dissipated power shall not be greater than the maximum permissible power dissipation stated in 1.3.9.
5. The free air ambient temperature for the capacitor is not exceeding the rated temperature.

Example : $C = 10 \text{ nF} - 1600\text{V}$ used for the following voltage signal

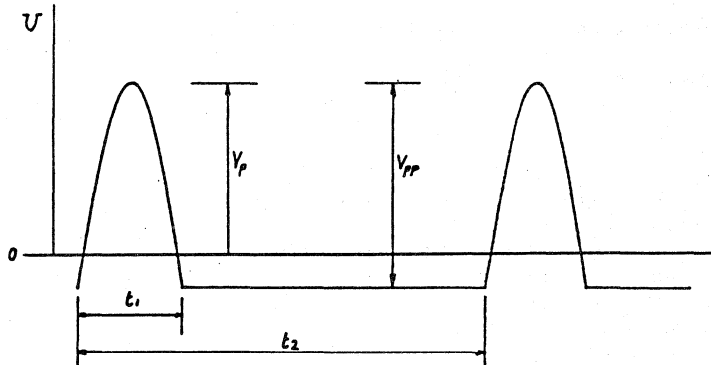

This is a half sinewave pulse with :

$$V_{pp} = 1200\text{V} \quad V_p = 1100\text{V} \quad t_1 = 12 \mu\text{s} \quad t_2 = 64 \mu\text{s}$$

The ambient temperature is 50°C .

Checking the 6 conditions

1. The peak voltage $V_p = 1100\text{V}$ is lower than 1600Vdc .
2. The peak to peak voltage 1200V is lower than $500\text{Vac } 2\sqrt{2} = 1414 V_{pp}$
3. The voltage pulse slope : of no consideration
4. The dissipated power is 75 mW as calculated with Fourier terms.
This is less than 320 mW , allowed for a capacitor with dimensions $7,5 \times 16,5 \times 26 \text{ mm}$ as seen in fig. 10.
5. The free air ambient temperature is 50°C , and lower than 85°C .

AC and pulse metallized polypropylene film capacitors

2222 376**1.4. Related documents**

Generic specification	IEC 384-1
Sectional specification	IEC 384-17

1.5. Marking

- Capacitors with l_{max} 17,5mm are marked on the top by embossed print with the following information :
 - Manufacturer's identification symbol ()
 - Code for factory of origin (HQ)
 - Manufacturer's type designation (e.g. 376)
 - Rated capacitance in pF en μ F
 - Tolerance on rated capacitance (e.g. 10)
 - Rated voltage (e.g. 630)
 - Code for dielectric material (KP/MMKP)
 - Production date code acc. to IEC-62, clause 5

Example :  6800/10/630
KP/MMKP 376 HQ ..

- Capacitors with l_{max} 26 or 31mm are marked on the top by laser print with the following information :
 - Capacitance n : nF
 - Rated voltage (e.g. 1000V)
 - Capacitance tolerance K : 10% J : 5% A : 3,5%
 - Manufacturer's type designation (376)
 - Code for dielectric material (KP/MMKP)
 - Manufacturer's name (PHILIPS)
 - Code for factory of origin (HQ)
 - Year and week of manufacturer (e.g. 9010)

Example : 33n K 1000V PHILIPS
376 KP/MMKP HQ 9010

AC and pulse metallized polypropylene film capacitors

2222 376

The package containing the capacitors is marked as follows

Data on label SPQ and PQ
(example)

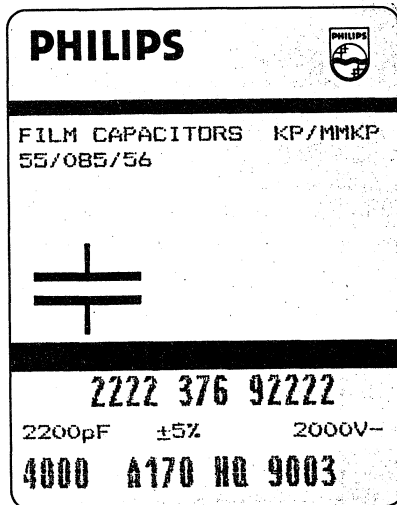

Block A : Philips word mark and emblem

Block B : Line 1 : Film capacitors and material code
Line 2 : Climatic group number

Capacitor symbol

Block C : Line 1 : Product code (12 NC)

Line 2 : Capacitance value
<10 K in pF followed by pF
>10K in μ F followed by μ F
Tolerance followed by + and %
Voltage followed by V-

Line 3 : Number of capacitors
Preference-origin code : A
Country of origin : Belgium=170
Responsible production centre :
Philips Roeselare = HQ
Production period : year- and week code (4 digits)

1.6. Ordering information

Order the capacitors by quoting the 12-digit catalogue number as shown in Tables 1 to 4.

1.7. Certified test records (CTR)

Not required.

AC and pulse metallized polypropylene film capacitors

2222 376

2. INSPECTION REQUIREMENTS

Note 1 : Sub-clause numbers of tests and performance requirements refer to the Sectional Specification, IEC-publication 384-17 and Section One of this specification.

Note 2 : Inspection levels and AQL's are selected from IEC-Publication 410 : Sampling Plans and Procedures for Inspection by attributes.

Note 3 : In this table :

- p = periodicity (in months)
- n = sample size
- c = acceptance criterion (permitted number of defectives)
- D = destructive
- ND = non-destructive
- IL = inspection level) IEC 410
- AQL = acceptable quality level)

Note 4 : For this capacitor, considered as a solid construction, it is permitted to reduce the periodicity of the vibration and shock test from 6 months to 36 months.
In the event of a single defective occurring in subgroup Clb at this reduced rate of testing, then the vibration and shock tests shall revert to a 6 monthly periodicity until three successive 6-monthly tests shall have produced no defectives.

AC and pulse metallized polypropylene film capacitors

2222 376

Clause number and Test (see Note 1)	D or ND	Conditions of Test (see Note 1)	IL (see Note 2)	AQL	Performance requirements (see Note 1)
<u>Group A Inspection (lot-by-lot)</u>					
<u>Sub-group A1</u>					
4.1 Visual examination	ND		I	2,5%	- No mechanical failures - Legible marking and as specified in GENERAL DATA of this specification.
4.2 Dimensions		Gauging			- As specified in Tables 1 to 4 of this specification.
<u>Sub-group A2</u>					
4.2.2 Capacitance	ND	at 1kHz	II	1%	- Within specified tolerance
4.2.3 Tangent of loss angle		at 100kHz			- As in GENERAL DATA of this specification.
4.2.1 Voltage proof (Test A)		at $1,6 \times U_{Rdc}$ for 1 s.			- No breakdown or flashover
4.2.4 Insulation resistance (Test A)		at 500V			- As in GENERAL DATA of this specification.

AC and pulse metallized polypropylene film capacitors

2222 376

Sub-clause number and Test (see Note 1)	D or ND	Conditions of test (see Note 1)	Sample size + criterion of acceptability (see Note 3)			Performance requirements
			p	n	c	
<hr/>						
<u>Group C inspection</u> (periodic)						
<u>Sub-group C1A</u>	D		6	9	1	
Part of sample of Sub-group C1						
4.1 Dimensions (detail)						As specified in Tables 1 to 4 of this specification
4.3.1 Initial measurements		Capacitance Tangent of loss angle				
4.3 Robustness of terminations		Tensile and bending				No visible damage
4.4 Resistance to soldering heat		Methode : 1A Solder bath : 260°C Duration : 10 s				
4.14 Component solvent resistance		Mixture : 1,1,2- trichlorotrifluoro- ethane and 2 - propanol(isopro- pyl alcohol) Temp. 48,6 to 50,5°C (boiling) Method : 2 Immersion time : 5 ± 0,5 min. Recovery time : min. 1h max. 2h				
4.4.2 Final measurements		Visual examination Capacitance Tangent of loss angle				No visible damage Legible marking $\Delta C < 1\%$ of the va- C lue measured initially. Increase of tan δ < 0,001 Compared to values measured in 4.3.1

AC and pulse metallized polypropylene film capacitors

2222 376

Sub-clause number and Test (see Note 1)	D or ND	Conditions of test (see Note 1)	Sample size + criterion of accepta- bility (see Note 3)			Performance requirements
			p	n	c	
Sub-group ClB Other part of sample of Sub-group Cl 4.6.1 Initial measurements	D	Capacitance Tangent of loss angle	6	18	1	
4.6 Rapid change of temperature		A=lower category temperature B=upper category temperature Five cycles Duration t = 30min. Visual examination				No visible damage
4.7 Vibration (see Note 4)		Method of mounting see GENERAL DATA of this specification. Procedure B4. Frequency range : 10Hz to 55Hz. Amplitude 0,75mm of acceleration 98m/s ² (whichever is the less severe) Total duration 6h				
4.7.2 Final inspection		Visual examination				No visible damage
4.9 Shock		Method of mounting see GENERAL DATA of this specification Pulse shape : half sine Accelerat.:490m/s ² Duration of pulse : 11ms				
4.9.3 Final measurements						No visible damage $\frac{\Delta C}{C} < 2\%$ for $C > 0,0047\mu F$ $\frac{\Delta C}{C} < 3\%$ for $C \leq 0,0047\mu F$

AC and pulse metallized polypropylene film capacitors

2222 376

Sub-clause number and Test (see Note 1)	D or ND	Conditions of test (see Note 1)	Sample size + criterion of accepta- bility (see Note 3)			Performance requirements
			p	n	c	
		Visual examination Capacitance Tangent of loss angle Insulation resis- tance.				of the value measu- red in 4.6.1 Increase of tan_delta <0,001 compared to values measured in 4.6.1 As in GENERAL DATA of this specification
<u>Sub-group C1</u>	D		6	27	2	
Combined sample of spe- cimens of Sub-groups C1A and C1B 4.10 Climatic sequence						
4.10.2 Dry heat		Temperature : upper category temperature Duration : 16h				
4.10.3 Damp heat cyclic, Test Db, first cycle						
4.10.4 Cold		Temperature : lower category temper. Duration : 2h				
4.10.6 Damp heat cyclic, Test Db remaining cycles						
4.10.6.2 Final measurements		Visual examination Capacitance Tangent of loss angle Insulation resis- tance.				No visible damage Legible marking $\frac{\Delta C}{C} < 3\%$ of value measured in 4.4.2. or 4.9.3. Increase of tan_delta <0,002 compared to values measured in 4.3.1 or 4.6.1 >50% of values in GENERAL DATA of this specification

AC and pulse metallized polypropylene film capacitors

2222 376

Sub-clause number and Test (see Note 1)	D or ND	Conditions of test (see Note 1)	Sample size + criterion of accepta- bility (see Note 3)			Performance requirements
			p	n	c	
<u>Sub-group C2</u>	D		6	15	1	
4.11 Damp heat steady state						
4.11.1 Initial measurements		Capacitance Tangent of loss angle				
4.11.3 Final measurements		Visual examination Capacitance Tangent of loss angle Insulation resistance				No visible damage Legible marking $\Delta \frac{C}{C} < 1\%$ of the C value measu- red in 4.11.1 Increase of tan_delt. $< 0,001$ compared to values measured in 4.11.1 >50% of values in GENERAL DATA of this specification

AC and pulse metallized polypropylene film capacitors

2222 376

Sub-clause number and Test (see Note 1)	D or ND	Conditions of test (see Note 1)	Sample size + criterion of accepta- bility (see Note 3)			Performance requirements
			p	n	c	
<u>Sub-group C3A</u>						
4.12.1 Endurance test at 50Hz alternating voltage	D	Duration : 1000h Temperature : 85°C Voltage : 1,25xrated a.c. voltage(r.m.s. value), 50Hz	3	20	1	
4.12.1.1 Initial measurements		Capacitance Tangent of loss angle				
4.12.1.3 Final measurements		Visual examination Capacitance Tangent of loss angle Insulation resistance				No visible damage $\Delta C / C < 2\%$ of value measured in 4.12.1 Increase of tan δ : $< 0,0015$ compared to va- lues measured in 4.12.1.1 $> 50\%$ of values in GENERAL DATA of this specification.
<u>Sub-group C4</u>						
4.2.6 Characteristics depending on temperature	D	Capacitance Insulation resis- tance	3	9	1	As in GENERAL DATA of this specificatio

AC and pulse metallized polypropylene film capacitors

2222 376

Additional tests	D or ND	Conditions of test	Sample size + criterion of accepta- bility			Performance requirements
			p	n	c	
<u>Sub-group ADD1</u>						
A.1. Solderability	D	Without ageing Methode : 1 Non-activated colophony flux Solder bath : 235°C Dwell time : 2 s.	3	35	1	Good tinning as evi- denced by free flo- wing of the solder with wetting of the terminations
Solvent resistance of the marking		Mixture 1,1,2- trichlorotrifluoro- ethane and 2- propanol (isopropylalcohol) Temp. 48,6 to 50,5°C (boiling) Method 1 Rubbing material : cotton wool Immersion time 5 ± 0,5 min.				Legible marking
<u>Sub-group ADD2</u>						
A.2 Heat storage	D	Duration : 2000h Temperature : upper category temperature	3	12	1	
A.2.1 Initial measurements		Capacitance Tangent of loss angle				
A.2.2 Final measurements		Capacitance Tangent of loss angle Insulation resistance				$\Delta \frac{C}{C} < 3\%$ of value C measured in A.2.1 Increase of tan δ < 0,002 compared to values measured in A.2.1 As in GENERAL DATA of this specifi- cation.

AC and pulse metallized polypropylene film capacitors

2222 376

Additional tests	D or ND	Conditions of test	Sample size + criterion of acceptability			Performance requirements
			p	n	c	
<hr/>						
<u>Sub-group ADD3</u>			3	9	1	
A.3 Detergent resistance		Density 20g/l Dishwasher detergent Temperature 70°C during 3 min. Followed by rinsing in clear water for 1 min. Recovery time min. 1h max. 2h				
A.3.1 Initial measurements		Capacitance Tangent of loss angle				
A.3.2 Final measurements		Capacitance Tangent of loss angle Insulation resistance				$\Delta \frac{C}{C} < 1\%$ of value measured in A.3.1 Increase of \tan_{δ} <0,001 compared to values measured in A.3.1 > 50% of values in GENERAL DATA of this specification.
<hr/>						
<u>Sub-group ADD4</u>	D		6	15	1	
A.4 Resistance to soldering heat with pre-heating.		Capacitors mounted on a 1,6mm board with nonplated holes Body temp. : 80°C Bath temp. : 260°C Dwell time : 5s				
A.4.1 Initial measurements		Capacitance Tangent of loss angle				
A.4.2 Final measurements		Capacitance Tangent of loss angle				$\Delta \frac{C}{C} < 2\%$ of value measured in A.4.1 Increase of \tan_{δ} >0,001 compared to values measured in A.4.1

AC and pulse metallized polypropylene film capacitors

2222 376

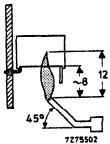
Additional tests	D or ND	Conditions of test	Sample size + criterion of accepta- bility			Performance requirements
			p	n	c	
<hr/>						
<u>Sub-group ADD5</u>	D		6	15	1	
A.5.1 Needle flame test IEC 40 (secr.)580 Class C		Bore of gas jet : $\varnothing 0,5\text{mm}$ Fuel : butane Test duration for actual volume V (mm^3) : $< 250 : 15 \text{ s}$ $250 < V < 500 = 30 \text{ s}$ $500 < V \leq 1750 = 60 \text{ s}$ $V > 1750 = 120\text{s}$ One flame applica- tion.				After removing the test flame from the capacitor, the ca- pacitor must not continue to burn for more than 3 s, no burning particle must drop from the sample.
						
<hr/>						
<u>Sub-group ADD6</u>			3	5	1	
A.6 Endurance under sinusoidal voltage		Duration : 24h Temperature : 23°C Voltage: 1,1 x permissible voltage Frequency : 20kHz				
A.6.2 Final measurements		Capacitor body temperature				$\Delta T \leq 15^\circ\text{C}$

AC and pulse metallized polypropylene film capacitors

2222 376

Additional tests	D or ND	Conditions of test	Sample size + criterion of accepta- bility			Performance requirements
			p	n	c	
<u>Sub-group ADD7</u>	D		3	21	1	
A.7 Endurance						
A.7.1 Initial measurements		Capacitance Tangent of loss angle				
A.7.2 Endurance DC		Duration : 2000h 1,25 U_{Rdc} at 85°C 1,25 U_C at 100°C				
A.7.3 Final measurements		Visual examination Capacitance Tangent of loss angle Insulation resistance				No visible damage Legible marking $\frac{\Delta C}{C} < 3\%$ the value measured in A.7.1 Increase of $\tan \delta$ < 0,002 compared to values measured in 4.12.1 >50% of values in GENERAL DATA of this specification
<u>Sub-group ADD8</u>	D		3	9	1	
A.8 Endurance test under 50Hz		Duration : 1000h Temp. : 23°C Voltage : 850V _{dc} + 550V _{ac} (for 1500V and 1600V version) 1000V _{dc} + 660V _{ac} (for 2000V version)				
A.8.1. Initial measurements		Capacitance				
A.8.2. Final measurements		Capacitance Insulation resistance				No interruption No short circuit

Philips Components

Data sheet	
status	Product specification
date of issue	May 1990

2222 378

AC and pulse metallized polypropylene film capacitors

MKP Radial potted type

- ° 22,5 and 27,5 mm terminal pitch
- ° Supplied loose in box and taped on reel

QUICK REFERENCE DATA

Capacitance range (E24-series)	0,0033 to 3,3 μ F
Capacitance tolerance	<u>+5%</u>
Rated voltage (d.c.)	250V, 400V, 630V, 1000V, 1600V, 2000V
Rated voltage (a.c.)	160V, 200V, 300V, 400V, 500V, 600V
Climatic category	55/085/56
Rated temperature (d.c.)	85°C
Rated temperature (a.c.)	70°C
Reference specification	IEC 384-17
Performance grade	Grade 1 (long life)
Stability grade	Grade 1

SURVEY OF STYLES

Style 2222 378
Terminal pitch : 22,5mm and 27,5mm
See Tables 1 to 6

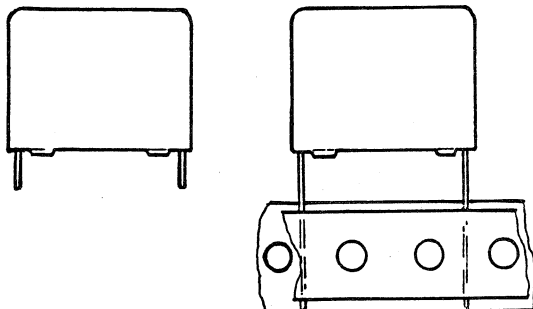

CONSTRUCTION

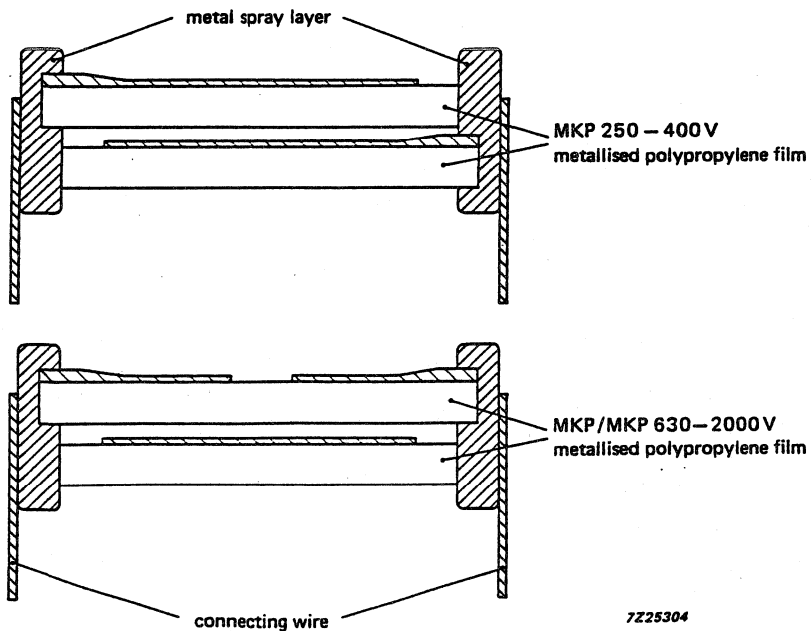

AC and pulse metallized polypropylene film capacitors

2222 378

APPLICATION

Low losses due to low contact resistance and low loss dielectric result in applications where high currents at high frequency and steep pulses occur or high stability is preferred. Their small dimensions make them suitable for circuits with high packaging density.

DESCRIPTION

The capacitors consist of a low-inductive wound cell of metallized polypropylene film. The cell is potted with blue epoxy resin in a blue flame retardent polypropylene case. The radial leads are of solder-coated wire. The capacitors can withstand solvents and rinsing liquids without damage. They are provided with small stand-off pips to allow removal of solder flux etc., during cleaning of the printed-wiring board.

1. GENERAL DATA

1.1. MountingNormal use

The capacitors are designed for printed wiring applications.

The capacitors packed in bandoliers are designed for mounting on printed-wiring boards by means of automatic insertion machines.

Specific method of mounting to withstand vibration and shock

In order to withstand vibration and shock tests, it must be insured that the stand-off pips are in good contact with the printed-wiring board.

The capacitors shall be mechanically fixed by the leads and the body shall be clamped.

AC and pulse metallized polypropylene film capacitors

2222 378

1.2.1 Dimensions in mm

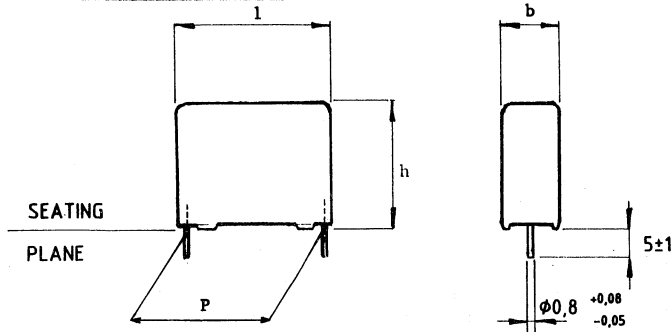

Fig. 1

Table 1 $U_{Rdc} = 250V$; U_{Rac} voltage = 160V

capacitance μF	b_{max}	h_{max}	l_{max}	P	mass g	catalogue number 2222 378		
						loose in box Fig. 1 C-tol $\pm 5\%$	taped on reel Fig. 2 C-tol $\pm 5\%$	
0,33	7	16,5	26	$22,5 \pm 0,4$	3,15	42334	45334	
0,36	7	16,5	26			42364	45364	
0,39	7	16,5	26			42394	45394	
0,43	8,5	18,0	26			42434	45434	
0,47	8,5	18,0	26			42474	45474	
0,51	8,5	18,0	26		4,4	42514	45514	
0,56	8,5	18,0	26			42564	45564	
0,62	8,5	18,0	26			42624	45624	
0,68	10	19,5	26			42684	45684	
0,75	10	19,5	26			5,5	42754	45754
0,82	10	19,5	26	42824	45824			
0,91	11	21	31	$27,5 \pm 0,4$	7,8	42914	45914	
1	11	21	31			42105	45105	
1,1	11	21	31			42115	45115	
1,2	11	21	31			42125	45125	
1,3	11	21	31			42135	45135	
1,5	13	23	31		10,4	42155	45155	
1,6	13	23	31			42165	45165	
1,8	13	23	31			42185	45185	
2	15	25	31			12,8	42205	45205
2,2	15	25	31				42225	45225
2,4	18	28	31		17,2	42245	45245	
2,7	18	28	31			42275	45275	
3	18	28	31			42305	45305	
3,3	18	28	31			42335	45335	

AC and pulse metallized polypropylene film capacitors

2222 378

Table 2 U_{Rdc} = 400V; U_{Rac} voltage = 200V, Fig.1

capacitance μF	b _{max}	h _{max}	l _{max}	P	mass g	catalogue number 2222 378	
						loose in box Fig. 1 C-tol + 5%	taped on reel Fig. 2 C-tol + 5%
0,18	7	16,5	26	22,5 ± 0,4	3,15	52184	55184
0,2	7	16,5	26			52204	55204
0,22	7	16,5	26			52224	55224
0,24	8,5	18,0	26		4,4	52244	55244
0,27	8,5	18,0	26			52274	55274
0,3	8,5	18,0	26		5,5	52304	55304
0,33	8,5	18,0	26			52334	55334
0,36	10	19,5	26			52364	55364
0,39	10	19,5	26		10,4	52394	55394
0,43	10	19,5	26			52434	55434
0,47	10	19,5	26			52474	55474
0,51	11	21	31			27,5 ± 0,4	52514
0,56	11	21	31		7,8		52564
0,62	11	21	31	52624			55624
0,68	11	21	31	52684			55684
0,75	13	23	31	10,4	52754		55754
0,82	13	23	31		52824		55824
0,91	13	23	31	12,8	52914		55914
1	13	23	31		52105		55105
1,1	15	25	31		52115		55115
1,2	15	25	31	17,2	52125		55125
1,3	15	25	31		52135		55135
1,5	18	28	31	17,2	52155		55155
1,6	18	28	31		52165		55165
1,8	18	28	31		52185		55185
2	18	28	31		52205		55205

AC and pulse metallized polypropylene film capacitors

2222 378

Table 3 $U_{Rdc} = 630V$; U_{Kac} voltage = 300V, Fig.1

capacitance μF	b_max	h_max	l_max	P	mass g	catalogue number 2222 378	
						loose in box Fig. 1 C-tol $\pm 5\%$	taped on reel Fig. 2 C-tol $\pm 5\%$
0,056	6	15,5	26		2,6	62563	65563
0,062	6	15,5	26			62623	65623
0,068	7	16,5	26			62683	65683
0,075	7	16,5	26		3,15	62753	65753
0,082	7	16,5	26			62823	65823
0,091	7	16,5	26			62913	65913
0,1	8,5	18,0	26	$22,5 \pm 0,4$		62104	65104
0,11	8,5	18,0	26		4,4	62114	65114
0,12	8,5	18,0	26			62124	65124
0,13	8,5	18,0	26			62134	65134
0,15	10	19,5	26			62154	65154
0,16	10	19,5	26		5,5	62164	65164
0,18	10	19,5	26			62184	65184
0,2	11	21	31			62204	65204
0,22	11	21	31			62224	65224
0,24	11	21	31		7,8	62244	65244
0,27	11	21	31			62274	65274
0,3	13	23	31			62304	65304
0,33	13	23	31		10,4	62334	65334
0,36	13	23	31	$27,5 \pm 0,4$		62364	65364
0,39	13	23	31			62394	65394
0,43	15	25	31			62434	65434
0,47	15	25	31		12,8	62474	65474
0,51	15	25	31			62514	65514
0,56	18	28	31			62564	65564
0,62	18	28	31		17,2	62624	65624
0,68	18	28	31			62684	65684

AC and pulse metallized polypropylene film capacitors

2222 378

Table 4 $U_{Rdc} = 1000V$; U_{Rac} voltage = 400V, Fig.1

capacitance μF	b_max	h_max	l_max	P	mass g	catalogue number 2222 378	
						loose in box Fig. 1 C-tol $\pm 5\%$	taped on reel Fig. 2 C-tol $\pm 5\%$
0,012	6	15,5	26	$22,5 \pm 0,4$	2,6	72123	75123
0,013	6	15,5	26			72133	75133
0,015	6	15,5	26			72153	75153
0,016	6	15,5	26			72163	75163
0,018	6	15,5	26			72183	75183
0,02	7	16,5	26		72203	75203	
0,022	7	16,5	26		3,15	72223	75223
0,024	7	16,5	26		72243	75243	
0,027	8,5	18,0	26		72273	75273	
0,03	8,5	18,0	26		4,4	72303	75303
0,033	8,5	18,0	26		72333	75333	
0,036	8,5	18,0	26		72363	75363	
0,039	10	19,5	26		72393	75393	
0,043	10	19,5	26		72433	75433	
0,047	10	19,5	26		5,5	72473	75473
0,051	10	19,5	26	72513	75513		
0,056	11	21	31	$27,5 \pm 0,4$	7,8	72563	75563
0,062	11	21	31			72623	75623
0,068	11	21	31			72683	75683
0,075	11	21	31		72753	75753	
0,082	11	21	31		72823	75823	
0,091	13	23	31		72913	75913	
0,1	13	23	31		10,4	72104	75104
0,11	13	23	31		72114	75114	
0,12	15	25	31		72124	75124	
0,13	15	25	31		12,8	72134	75134
0,15	15	25	31		72154	75154	
0,16	18	28	31		72164	75164	
0,18	18	28	31		72184	75184	
0,2	18	28	31		17,2	72204	75204
0,22	18	28	31		72224	75224	

AC and pulse metallized polypropylene film capacitors

2222 378

Table 5 $U_{Rdc} = 1600V$; U_{Rac} voltage = 500V, Fig.1

capacitance μF	b_max	h_max	l_max	P	mass g	catalogue number 2222 378	
						loose in box Fig. 1 C-tol $\pm 5\%$	taped on reel Fig. 2 C-tol $\pm 5\%$
0,0056	6	15,5	26	$22,5 \pm 0,4$	2,6	82562	85562
0,0062	6	15,5	26			82622	85622
0,0068	6	15,5	26			82682	85682
0,0075	7	16,5	26		82752	85752	
0,0082	7	16,5	26		82822	85822	
0,0091	7	16,5	26		82912	85912	
0,01	7	16,5	26		3,15	82103	85103
0,011	8,5	18,0	26		4,4	82113	85113
0,012	8,5	18,0	26			82123	85123
0,013	8,5	18,0	26			82133	85133
0,015	8,5	18,0	26			82153	85153
0,016	8,5	18,0	26			82163	85163
0,018	10	19,5	26			82183	85183
0,02	10	19,5	26		5,5	82203	85203
0,022	10	19,5	26		82223	85223	
0,024	11	21	31	$27,5 \pm 0,4$	7,8	82243	85243
0,027	11	21	31			82273	85273
0,03	11	21	31			82303	85303
0,033	11	21	31		82333	85333	
0,036	11	21	31		82363	85363	
0,039	13	23	31		82393	85393	
0,043	13	23	31		10,4	82433	85433
0,047	13	23	31		82473	85473	
0,051	13	23	31		82513	85513	
0,056	15	25	31		12,8	82563	85563
0,062	15	25	31			82623	85623
0,068	15	25	31			82683	85683
0,075	18	28	31		82753	85753	
0,082	18	28	31		82823	85823	
0,091	18	28	31		17,2	82913	85913
0,1	18	28	31	82104	85104		

AC and pulse metallized polypropylene film capacitors

2222 378

Table 6 $U_{Rdc} = 2000V$; U_{Rac} voltage = 600V, Fig.1

capacitance μF	b_max	h_max	l_max	P	mass g	catalogue number 2222 378	
						loose in box Fig. 1 C-tol + 5%	taped on reel Fig. 2 C-tol + 5%
0,0033	6	15,5	26		2,6	92332	95332
0,0036	6	15,5	26			92362	95362
0,0039	7	16,5	26			92392	95392
0,0043	7	16,5	26		3,15	92432	95432
0,0047	7	16,5	26			92472	95472
0,0051	7	16,5	26			92512	95512
0,0056	8,5	18,0	26	$22,5 \pm 0,4$		92562	95562
0,0062	8,5	18,0	26			92622	95622
0,0068	8,5	18,0	26		4,4	92682	95682
0,0075	8,5	18,0	26			92752	95752
0,0082	8,5	18,0	26			92822	95822
0,0091	10	19,5	26			92912	95912
0,01	10	19,5	26			92103	95103
0,011	10	19,5	26		5,5	92113	95113
0,012	10	19,5	26			92123	95123
0,013	11	21	31	$27,5 \pm 0,4$		92133	95133
0,015	11	21	31			7,8	92153

AC and pulse metallized polypropylene film capacitors

2222 378**1.2.2 Packing**

The capacitors are supplied loose in box and taped on reel, details of quantities are given in Tables 7 to 8.

Loose in box

Table 7 : Number of capacitors per box.

$\frac{l_{max}}{mm}$	number of capacitors per box	
	SPQ	PQ
26	200	1000
31	100	500

Taped on reel

1. Dimensions of taped products

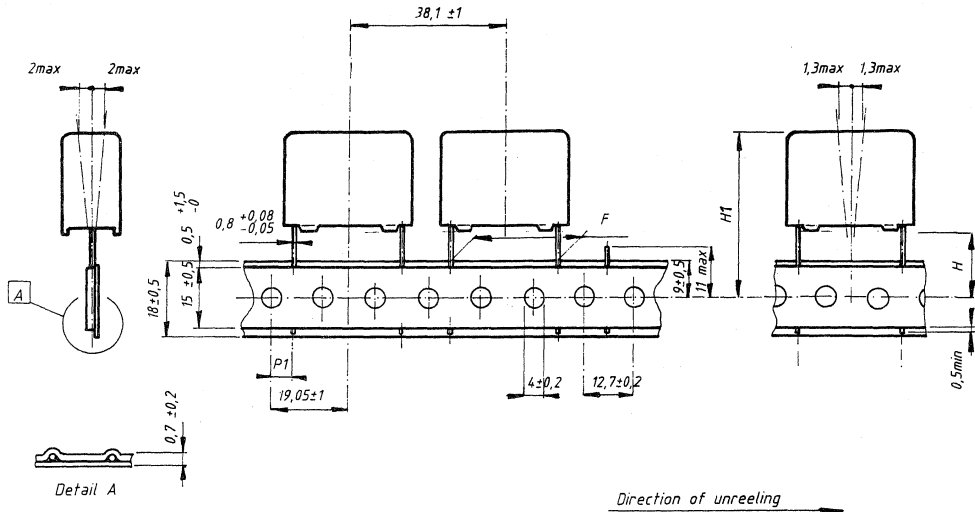

FOR PHYSICAL DIMENSIONS SEE PRODUCT SPECIFICATION

ITEM	SYMBOL	VALUE	VALUE	TOLERANCE
Lead to lead distance	F	22,5	27,5	+0,5/-0,1
Height of component from tape center to seating plane	H		18,5	±0,5
Component height from tape center	H1	max 40	max 48	for h1=18,5
Feed hole to lead center	P1	7,8	5,33	±0,7

Fig. 2

2. Characteristics of taped products

- Pull-out force of the component > 5N
- Pull-off force of the adhesive tape > 6N
- Tearing force of tape > 15N
- Storage conditions
 - storage temperature -25°C to +40°C
 - relative humidity max. 80% without condensation

3. Outlines of reel packing

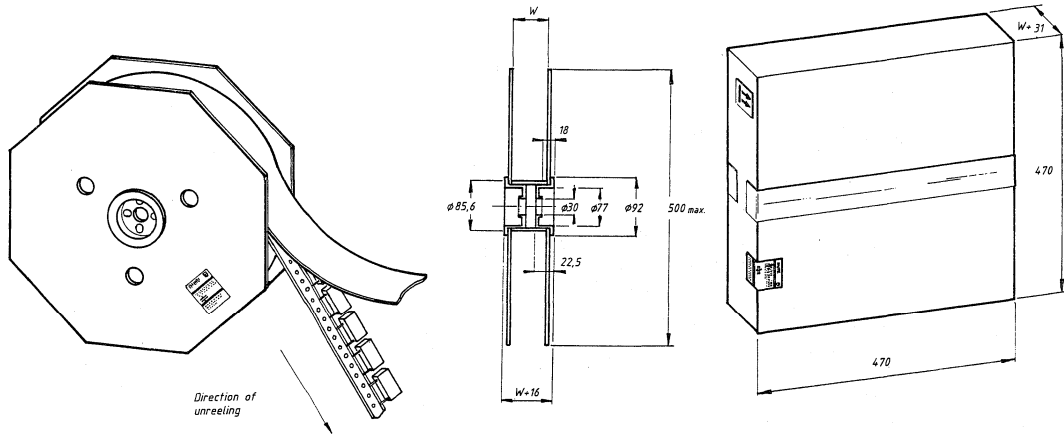

Fig. 3

4. Number of capacitors per reel

Table 8

b _{max}	Number per reel	W ± 2mm
6	600	50
7	550	50
8,5	450	50
10	350	55
11	300	55
13	250	55
15	200	60
18	150	60

AC and pulse metallized polypropylene film capacitors

2222 378

1.3 Ratings and characteristics

Unless otherwise specified all electrical values apply to an ambient free air temperature of $23 \pm 1^\circ\text{C}$, an atmospheric pressure of 86 to 106 kPa and a relative humidity of $50 \pm 2\%$.

1.3.1 Capacitance

Capacitance range at 1 kHz see Tables 1 to 6

Capacitance tolerance see Tables 1 to 6

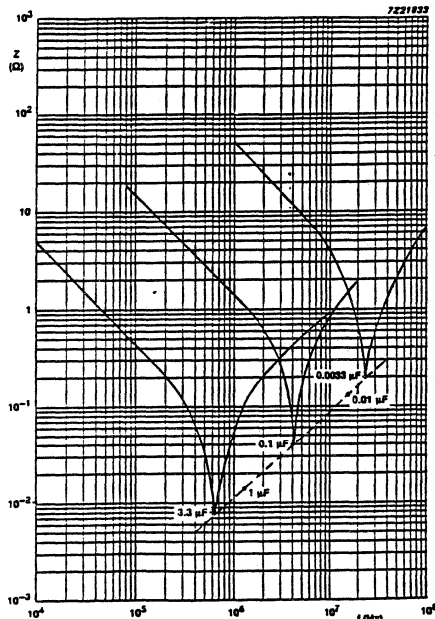

Fig. 4 : Impedance as a function of frequency ; typical curve.

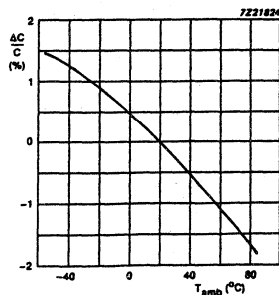

Fig. 5 : Capacitance as a function of temperature (typical curve)

1.3.2 Voltage

Rated voltage U_{Rdc} See Tables 1 to 6

Rated voltage U_{Rac} See Tables 1 to 6

Category voltage U_C U_R for $T = 85^\circ C$

Test voltage

between terminations $1,6 \times U_{Rdc}$

between interconnected terminations: 2840 Vdc
and case (foil method)

Maximum r.m.s voltage as a function of frequency : See Fig. 6 to 11

Maximum r.m.s. voltage as a function of temperature :

The maximum r.m.s. voltage in figs. 6 to 11 must be multiplied by a factor depending of the ambient temperature.

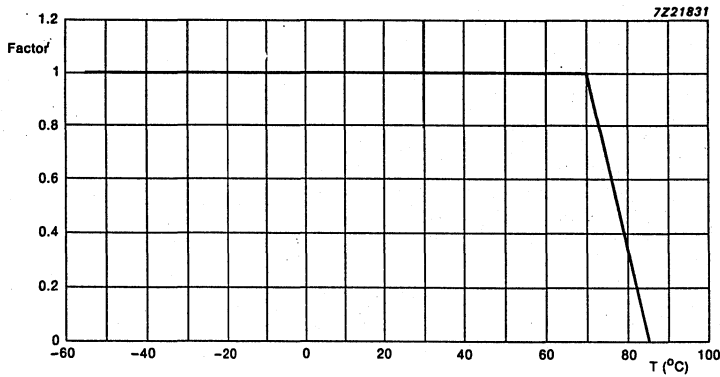

Fig. 6 : Multiplying factor as a function of temperature.

AC and pulse metallized polypropylene film capacitors

2222 378

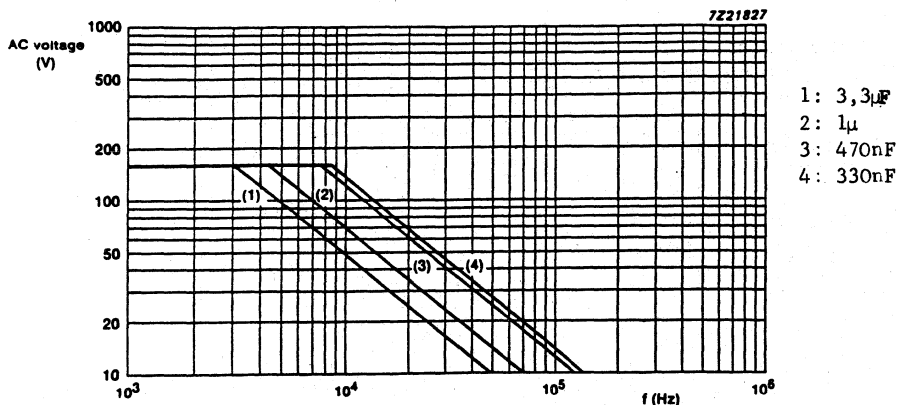

Fig. 7 : a.c. voltage(r.m.s. value) as a function of frequency at $T_{amb} \leq 70^{\circ}C$, for $U_{Rdc} = 250V$.

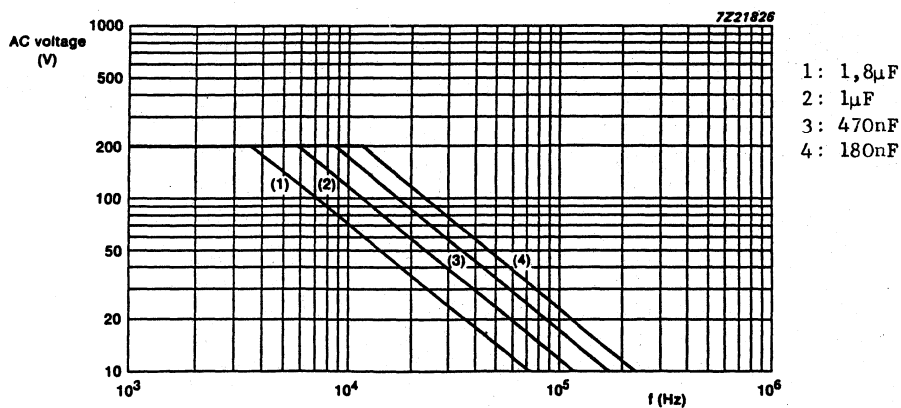

Fig. 8 : a.c. voltage(r.m.s. value) as a function of frequency at $T_{amb} \leq 70^{\circ}C$, for $U_{Rdc} = 400V$.

AC and pulse metallized polypropylene film capacitors

2222 378

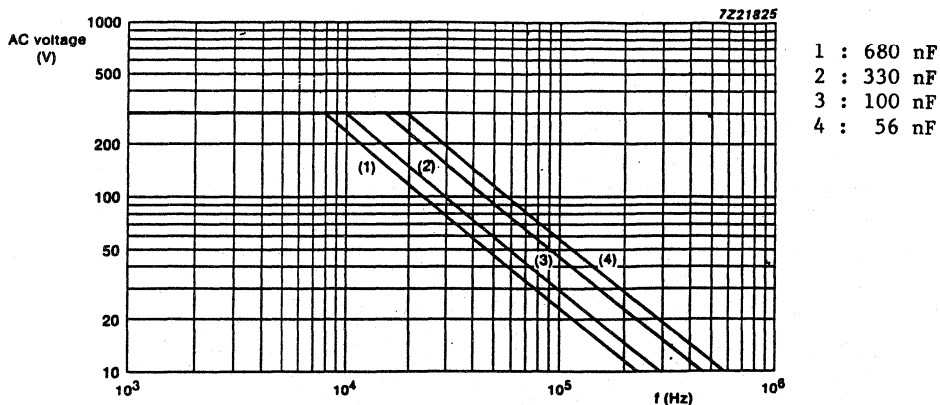

Fig. 9 : a.c. voltage(r.m.s. value) as a function of frequency at $T_{amb} \leq 70^{\circ}C$,
for $U_{Rdc} = 630V$.

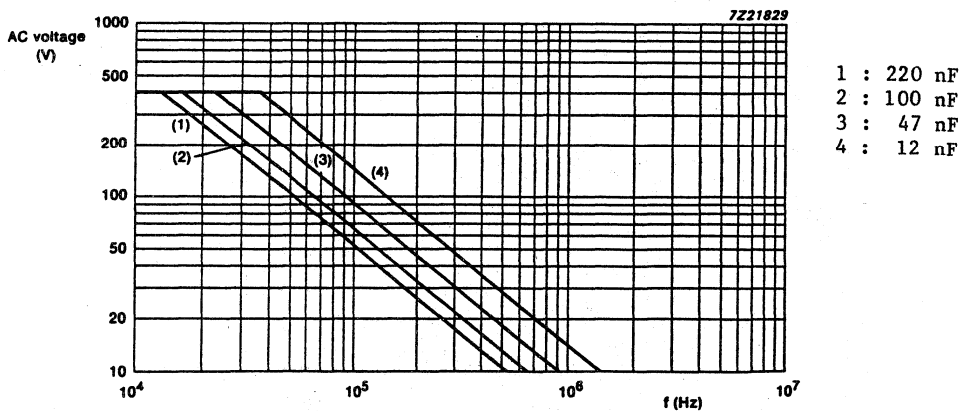

Fig. 10 : a.c. voltage(r.m.s. value) as a function of frequency at $T_{amb} \leq 70^{\circ}C$,
for $U_{Rdc} = 1000V$.

AC and pulse metallized polypropylene film capacitors

2222 378

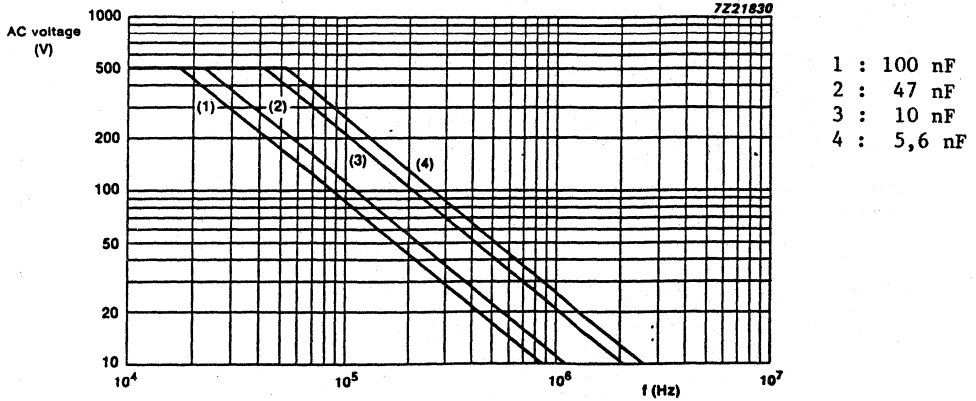

Fig. 11 : a.c. voltage(r.m.s. value) as a function of frequency at $T_{amb} \leq 70^{\circ}C$, for $U_{Rdc} = 1600V$.

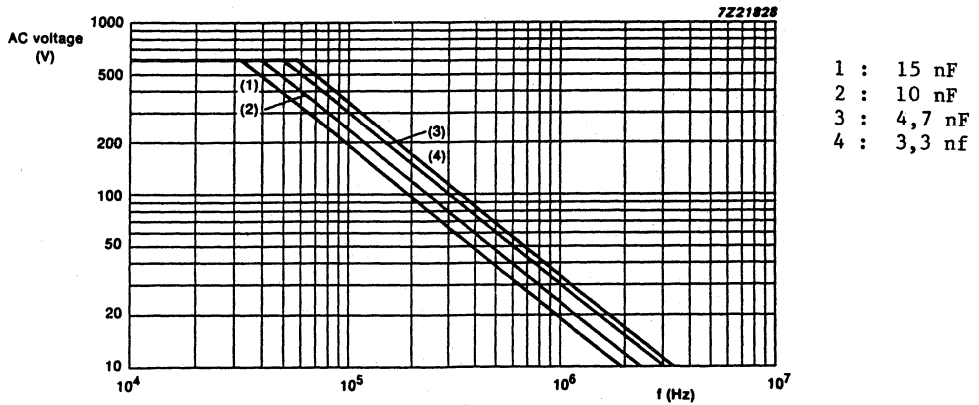

Fig. 12 : a.c. voltage(r.m.s. value) as a function of frequency at $T_{amb} \leq 70^{\circ}C$, for $U_{Rdc} = 2000V$.

AC and pulse metallized polypropylene film capacitors

2222 378

1.3.3 Climatic category

55/085/56

1.3.4 Rated temperature

rated temperature (d.c.)

85°C

rated temperature (a.c.)

70°C

1.3.5 Storage temperature range

Temperature -25 to +40°C

RH max. 80% without condensation

1.3.6 Tangent of loss angle (maximum)

Rated voltage	capacitance	Tangent of loss angle ($\times 10^{-4}$)	
		10 kHz	100 kHz
250	0.33 - 0.43	15	45
	0.47 - 0.62	15	55
	0.68 - 0.82	15	60
	0.91 - 1	20	90
	1.1 - 3.3	20	-
400	0.18 - 0.24	10	30
	0.27 - 0.36	10	35
	0.39 - 0.51	10	40
	0.56 - 0.68	15	50
	0.75 - 1	15	70
1.1 - 2	15	-	
630	0.056 - 0.18	8	15
	0.20 - 0.30	10	25
	0.33 - 0.39	10	30
	0.43 - 0.51	10	40
	0.56 - 0.68	10	45
1000	0.012 - 0.051	6	15
	0.056 - 0.22	8	20
1600	0.0056 - 0.022	5	10
	0.024 - 0.1	6	15
2000	0.0033 - 0.012	5	10
	0.013 - 0.015	5	10

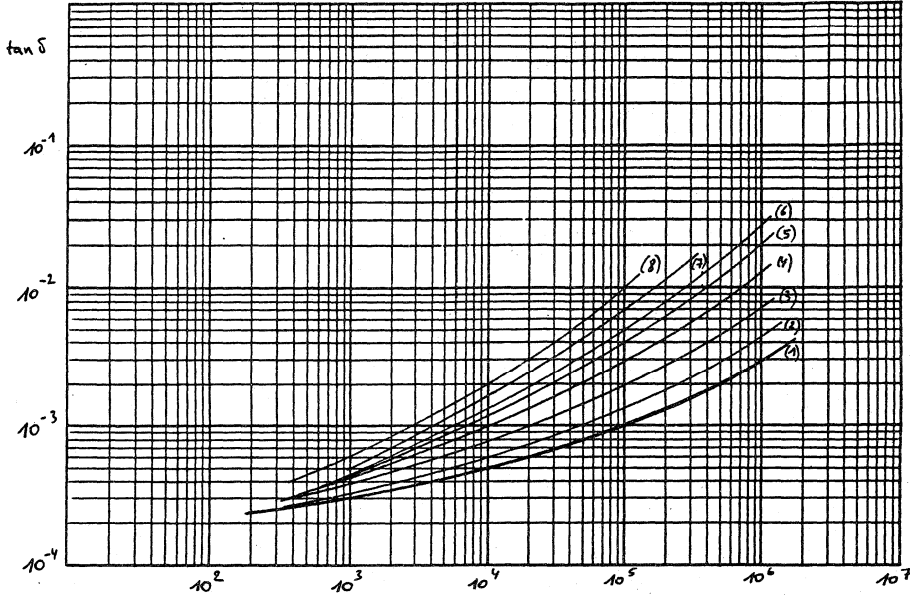

- Curve 1 : 2000V version
1600V version, $C < 22\text{nF}$
- 2 : 1600V version, $C > 24\text{nF}$
1000V version, $C < 51\text{nF}$
630V version, $C < 0,18\mu\text{F}$
- 3 : 1000V version, $C > 56\text{nF}$
- 4 : 630V version, $0,2\mu\text{F} < C < 0,39\mu\text{F}$
400V version, $C < 0,24\mu\text{F}$
- 5 : 630V version, $0,43\mu\text{F} < C < 0,51\mu\text{F}$
400V version, $0,27\mu\text{F} < C < 0,51\mu\text{F}$
- 6 : 630V version, $C > 0,56\mu\text{F}$
400V version, $0,56\mu\text{F} < C < 0,68\mu\text{F}$
250V version, $C < 0,43\mu\text{F}$
- 7 : 400V version, $0,75\mu\text{F} < C < 1\mu\text{F}$
250V version, $0,47\mu\text{F} < C < 0,82\mu\text{F}$
- 8 : 400V version, $C > 1,1\mu\text{F}$
250V version, $C > 0,91\mu\text{F}$

Fig. 13 : \tan_{delta} as a function of frequency, max. values.

1.3.7 Rated voltage pulse slope $\left(\frac{dU}{dt}\right)_R$

Rated pulse voltage = U_{Rdc}

rated voltage V	rated voltage pulse slope (V/μs)		
	l = 26mm	l = 31mm	
		b _{max} < 15mm	b _{max} ≥ 15mm
250	90	60	30
400	100	70	35
630	370	230	120
1000	1200	600	300
1600	1600	900	450
2000	2000	1200	

The rated voltage pulse slopes in the table are valid for pulse voltages equal to the rated voltage.

For lower pulse voltages the given values may be multiplied by U_{Rdc} and divided by the applied voltage.

1.3.8 Insulation resistance at $T_{amb} 20^\circ C$

The insulation resistance is measured after a voltage has been applied for 1 min. ± 5 s, the voltage being 100 ± 15V for the 250 and 400V versions, and 500 ± 50V for the 630V, 1000V, 1600V and 2000V versions.

R between terminations, for $C \leq 1 \mu F$ > 100.000 MΩ

RC between terminations, for $C > 1 \mu F$ > 100.000 ΩF

R between interconnected terminations and case > 100.000 MΩ
(foil method)

1.3.9 Maximum dissipation

The power dissipated by a capacitor is a function of the voltage U_{esr} across or the current I through the series resistance ESR and is expressed by:

$$P = \frac{U_{esr}^2}{ESR} \quad (1) \quad \text{or } P = ESR \cdot I^2 \quad (2)$$

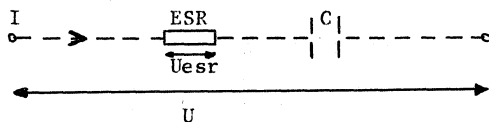

$$U_{esr}^2 = \frac{ESR^2}{ESR^2 + 1/w^2C^2} \cdot U^2 \quad (3a)$$

As for film capacitors $\tan_{\delta} = w.C.ESR \ll 0.1$, the formula (3a) can be simplified to

$$U_{esr}^2 = ESR^2 \cdot w^2 \cdot C^2 \cdot U^2 \quad (3b)$$

or with $ESR = \tan_{\delta}/wC$, we become:

$$P = w.C.\tan_{\delta}.U^2 \quad (4) \quad \text{or } P = \frac{\tan_{\delta}}{w.C} I^2 \quad (5)$$

For the \tan_{δ} we can take the value found from fig.13, C is in farad and $w = 2.\pi.f$.

U or I are assumed to be known.

The maximum permissible power dissipation (P_{max}), which depends on the dimensions of the capacitor and on the ambient free air temperature can be found from fig.14.

In applications where sine waves occur, we have to take for U the RMS-voltage or for I the RMS-current of the sine wave.

In applications where periodic signals occur, the signal has to be expressed in Fourier-terms:

$$U = U_0 + \sum_{k=1}^{\infty} \sin(kwt + \varphi_k) \quad (6)$$

$$I = \sum_{k=1}^{\infty} I_k \sin(k\omega t + \varphi_k) \quad (7)$$

with U_0 the D.C.voltage, U_k and I_k the voltage resp. current of the k -th harmonic.

We become for the dissipated power :

$$\text{with (6)} \quad P = \sum_{k=1}^{\infty} k \cdot w \cdot c \cdot \tan_{\text{delta}_k} \frac{U_k^2}{2} \quad (8)$$

$$\text{with (7)} \quad P = \sum_{k=1}^{\infty} \frac{\tan_{\text{delta}_k} \cdot I_k^2}{k \cdot w \cdot C \cdot 2} \quad (9)$$

and \tan_{delta_k} is the \tan_{delta} at the k -th harmonic.

AC and pulse metallized polypropylene film capacitors

2222 378

Curve	Dimensions (mm)		
	b_max	h_max	l_max
1	6	15,5	26
2	7	16,5	26
3	8,5	18,0	26
4	10	19,5	26
5	11	21	31
6	13	23	31
7	15	25	31
8	18	28	31

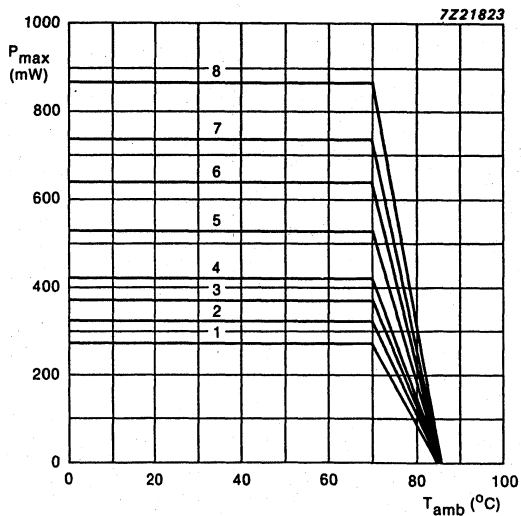

Fig.14 : Maximum permissible power dissipation as a function of ambient free air temperature, at various capacitor dimensions.

1.3.10 Application note

To select this capacitor for a certain application you have to check 6 conditions :

1. The peak voltage (U_p) shall not be greater than the rated d.c. voltage.
2. The peak to peak voltage (U_{pp}) shall not be greater than $2\sqrt{2}$ times the rated a.c. voltage to avoid the ionisation inception level.
3. The peak current (I_p) shall not exceed the maximum peak current, defined as maximum voltage pulse slope (dU/dt) multiplied by the capacitance.

$$I_p \text{ max} = C \left(\frac{dU}{dt} \right) \text{ max.}$$

Or the voltage pulse slope shall not exceed the rated voltage pulse slope.
If the pulse voltage is lower than the rated voltage, the values of tabel 1.3 may be multiplied by U_{Rdc} and divided by applied voltage.

4. The dissipated power shall not be greater than the maximum permissible power dissipation stated in 1.3.9.
5. The free air ambient temperature for the capacitor is not exceeding the category temperature.
6. Since all metallised film capacitors have always intrinsically active flammability risk, it is recommended to use these capacitors only in these circuits where in case of failure of the capacitor the power can be limited to less than 5 VA to the capacitor.

AC and pulse metallized polypropylene film capacitors

2222 378

Example : $C = 10 \text{ nF} - 1600\text{V}$ used for the following voltage signal

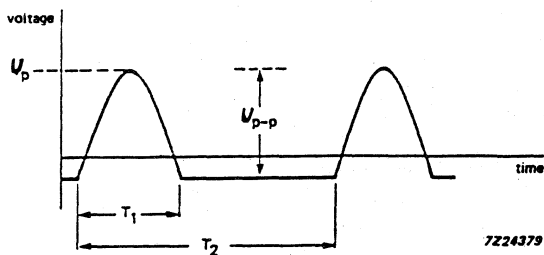

This is a half sinewave pulse with :

$$U_{pp} = 1200\text{V} \quad U_p = 1100\text{V} \quad t_1 = 12 \mu\text{s} \quad t_2 = 64 \mu\text{s}$$

In case of capacitor foilure, the power is switched off.
The ambient temperature is 50°C .

Checking the 6 conditions

1. The peak voltage $U_p = 1100\text{V}$ is lower than 1600Vdc .
2. The peak to peak voltage 1200V is lower than $500\text{Vac } 2\sqrt{2} = 1414 U_{pp}$
3. The voltage pulse slope $dU/dt = \frac{2}{24} 1200\text{V}/\mu\text{s} = 320\text{V}/\mu\text{s}$.
This is lower than $1600\text{V}/\mu\text{s}$ in table 1.3.7
4. The dissipated power is 180 mW as calculated with Fourier terms.
This is less than 320 mW , allowed for a capacitor with dimensions $7,0 \times 16,5 \times 26\text{mm}$ seen in fig. 14.
5. The free air ambient temperature is 50°C , and lower than 70°C .
6. In case of failure, the power is switched off.

AC and pulse metallized polypropylene film capacitors

2222 378**1.4. Related documents**

Generic specification	IEC 384-1
Sectional specification	IEC 384-17

1.5. Marking

The capacitors are marked on the top by laser print with the following information :

- Capacitance n : nF μ : μF
- Rated voltage (e.g. 1000V)
- Capacitance tolerance J : 5%
- Manufacturer's type designation (378)
- Code for diélectric material (MKP or MKP/MKP)
- Manufacturer's name (PHILIPS)
- Code for factory of origin (HQ)
- Year and week of manufacture (e.g. 9010)

Examples : 4n7 J 2000V PHILIPS 3μ3 J 250V PHILIPS
 378 MKP/MKP HQ 9010 378 MKP HQ 9010

AC and pulse metallized polypropylene film capacitors

2222 378

The package containing the capacitors is marked as follows

Data on label SPQ and PQ
(example)

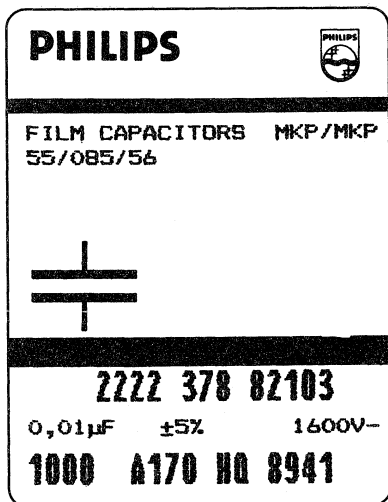

Block A : Philips word mark and emblem

Block B : Line 1 : Film capacitors and
material code
Line 2 : Climatic group number

Capacitor symbol

Block C : Line 1 : Product code (12 NC)

Line 2 : Capacitance value
<10 K in pF followed by pF
>10K in μ F followed by μ F
Tolerance followed by + and %
Voltage followed by V-

Line 3 : Number of capacitors
Preference-origin code : A
Country of origin : Belgium=170
Responsible production centre :
Philips Roeselare = HQ
Production period : year- and
week code (4 digits)

1.6. Ordering information

Order the capacitors by quoting the 12-digit catalogue number as shown in Tables 1 to 6.

1.7. Certified test records (CTR)

Not required.

2. INSPECTION REQUIREMENTS

Note 1 : Sub-clause numbers of tests and performance requirements refer to the Sectional Specification, IEC 384-17 and Section One of this specification.

Note 2 : Inspection levels and AQL's are selected from IEC-Publication 410 : Sampling Plans and Procedures for Inspection by attributes.

Note 3 : In this table :

- p = periodicity (in months)
- n = sample size
- c = acceptance criterion (permitted number of defectives)
- D = destructive
- ND = non-destructive
- IL = inspection level) IEC 410
- AQL = acceptable quality level)

Note 4 : For this capacitor, considered as a solid construction, it is permitted to reduce the periodicity of the vibration and shock test from 6 months to 36 months.
In the event of a single defective occurring in subgroup Clb at this reduced rate of testing, then the vibration and shock tests shall revert to a 6 monthly periodicity until three successive 6-monthly tests shall have produced no defectives.

AC and pulse metallized polypropylene film capacitors

2222 378

Clause number and Test (see Note 1)	D or ND	Conditions of Test (see Note 1)	IL (see Note 2)	AQL	Performance requirements (see Note 1)
<u>Group A Inspection (lot-by-lot)</u>					
<u>Sub-group A1</u>					
4.1 Visual examination	ND		II	2,5%	- No mechanical failures - Legible marking and as specified in GENERAL DATA of this specification.
4.2 Dimensions		Gauging			- As specified in Table 1 to 6 of this specification.
<u>Sub-group A2</u>					
4.2.2 Capacitance	ND	at 1kHz	II	1%	- Within specified tolerance
4.2.3 Tangent of loss angle		for $C < 1\mu\text{F}$ at 100kHz for $C > 1\mu\text{F}$ at 10kHz			- As in GENERAL DATA of this specification.
4.2.1 Voltage proof (Test A)		at $1,6 \times U_{Rdc}$ for 1s			- No breakdown or flashover
4.2.4 Insulation resistance (Test A)		at 100V for $U_{Rdc} < 630\text{V}$ at 500V for $U_{Rdc} \geq 630\text{V}$			- As in GENERAL DATA of this specification.

AC and pulse metallized polypropylene film capacitors

2222 378

Sub-clause number and Test (see Note 1)	D or ND	Conditions of test (see Note 1)	Sample size + criterion of acceptability (see Note 3)			Performance requirements
			p	n	c	
Group C inspection (periodic)						
Sub-group C1A	D		6	9	1	
Part of sample of Sub-group C1						
4.1 Dimensions (detail)						As specified in Tables 1 to 6 of this specification
4.3.1 Initial measurements		Capacitance Tangent of loss angle for C $\leq 1\mu\text{F}$ at 100kHz for C >math>1\mu\text{F}</math> at 10kHz				
4.3 Robustness of terminations		Tensile and bending				No visible damage
4.4 Resistance to soldering heat		Method: 1A Solder bath: 260°C Duration: 10 s				
4.14 Component solvent resistance		Mixture 1,1,2-trichlorotrifluoroethane and 2-propanol(isopropylalcohol) Temp.: 48,6 to 50,5°C (boiling). Method: 2 Immersion time: 5 ± 0,5 min. Recovery time: min. 1h max. 2h				
4.4.2 Final measurements		Visual examination Capacitance Tangent of loss angle				No visible damage Legible marking $\frac{\Delta C}{C}$ <math>< 1\%</math> of the value measured initially. Increase of tan delta <math>< 0,0005</math> for C $\leq 100\text{nF}$ <math>< 0,001</math> for C >math>100\text{nF}</math> <math>< 470\text{nF}</math> <math>< 0,0015</math> for C >math>470\text{nF}</math> Compared with 4.3.1

AC and pulse metallized polypropylene film capacitors

2222 378

Sub-clause number and Test (see Note 1)	D or ND	Conditions of test (see Note 1)	Sample size + criterion of accepta- bility (see Note 3)			Performance requirements
			p	n	c	
<u>Sub-group ClB</u>	D		6	18	2	
Other part of sample of Sub-group Cl						
4.6.1 Initial measurements		Capacitance Tangent of loss angle for C < 1 μ F at 100kHz for C > 1 μ F at 10kHz				
4.6 Rapid change of temperature		θ A=lower category temperature θ B=upper category temperature Five cycles Duration t = 30min. Visual examination				No visible damage
4.7 Vibration (see note 4)		Method of mounting see GENERAL DATA of this specification. Procedure B4. Frequency range : 10Hz to 55Hz. Amplitude 0,75mm of acceleration 98m/s ² (whichever is the less severe) Total duration 6h				
4.7.2 Final inspection		Visual examination				No visible damage
4.9 Shock (see note 4)		Method of mounting see GENERAL DATA of this specification. Pulse shape : half sine Acceleration : 490m/s ² Duration of pulse : 11 ms				

AC and pulse metallized polypropylene film capacitors

2222 378

Sub-clause number and Test (see Note 1)	D or ND	Conditions of test (see Note)	Sample size + criterion of accepta- bility (see Note 3)			Performance requirements
			p	n	c	
4.9.3 Final measurements		Visual examination Capacitance Tangent of loss angle Insulation resis- tance.				No visible damage $\Delta C \leq 1\%$ of the va- lue measured in 4.6.1 Increase of $\tan \delta$ $< 0,0005$ for $C < 100nF$ $< 0,001$ for $C > 100nF$ $< 470nF$ $< 0,0015$ for $C > 470nF$ compared with 4.6.1 or 4.3.1 As in GENERAL DATA of this specifi- cation.
<u>Sub-group C1</u>	D		6	27	3	
Combined sample of spe- cimens of Sub-groups C1A and C1B						
4.10 Climatic sequence						
4.10.2 Dry heat		Temperature : upper category temperature Duration : 16h				
4.10.3 Damp heat cyclic, Test Db, first cycle						
4.10.4 Cold		Temperature : lower category temperature Duration : 2h				
4.10.6 Damp heat cyclic, Test Db remaining cycles						

AC and pulse metallized polypropylene film capacitors

2222 378

Sub-clause number and Test (see Note 1)	D or ND	Conditions of test (see Note 1)	Sample size + criterion of accepta- bility (see Note 3)			Performance requirements
			p	n	c	
4.10.6.2 Final measurements		Visual examination Capacitance Tangent of loss angle Insulation resi- tance				No visible damage Legible marking $\frac{\Delta C}{C} \leq 1\%$ of value measured in 4.4.2. or 4.9.3. Increase of tan delta $< 0,0005$ for $C < 100nF$ $< 0,001$ for $C > 100nF$ $< 470nF$ $< 0,0015$ for $C > 470nF$ compared with 4.6.1 or 4.3.1 $> 50\%$ of values in GENERAL DATA of this specification
<u>Sub-group C2</u>	D		6	15	2	
4.11 Damp heat steady state						
4.11.1 Initial measurements		Capacitance Tangent of loss angle for $C \leq 1\mu F$ at 100kHz for $C > 1\mu F$ at 10kHz				
4.11.3 Final measurements		Visual examination Capacitance Tangent of loss angle Insulation resi- tance.				No visible damage Legible marking $\frac{\Delta C}{C} < 1\%$ of the value measu- red in 4.11.1 Increase of tan delta $< 0,0005$ for $C < 100nF$ $< 0,001$ for $C > 100nF$ $< 470nF$ $< 0,0015$ for $C > 470nF$ compared with 4.11.1 $> 50\%$ of values in GENERAL DATA of this specification

AC and pulse metallized polypropylene film capacitors

2222 378

Sub-clause number and Test (see Note 1)	D or ND	Conditions of test (see Note 1)	Sample size + criterion of accepta- bility (see Note 3)			Performance requirements
			p	n	c	
<u>Sub-group C3A</u>	D		3	20	2	
4.12 Endurance						
4.12.3 Endurance test under 50Hz		Duration : 1000h Temperature : 85°C Voltage : 1,25 rated a.c. voltage (r.m.s. value) 50Hz				
4.12.1.1 Initial measurements		Capacitance Tangent of loss angle for C $\leq 1\mu\text{F}$ at 100kHz for C $> 1\mu\text{F}$ at 10 kHz				
4.12.1.3 Final measurements		Capacitance Tangent of loss angle Insulation resistance				$\Delta C \leq 5\%$ of value measured in 4.12.1 Increase of $\tan \delta$ $\leq 0,0005$ for C $\leq 100\text{nF}$ $\leq 0,001$ for C $> 100\text{nF}$ $< 470\text{nF}$ $\leq 0,0015$ for C $> 470\text{nF}$ compared with 4.12.1 $> 50\%$ of values in GENERAL DATA of this specification.

AC and pulse metallized polypropylene film capacitors

2222 378

Sub-clause number and Test (see Note 1)	D or ND	Conditions of test (see Note 1)	Sample size + criterion of accepta- bility (see Note 3)			Performance requirements
			p	n	c	
<hr/>						
<u>Sub-group C4</u>	D		3	9	1	
4.2.6 Temperature characteristics						
Initial measurement Temp. change Intermediate measurements		Capacitance Lower category temp. Capacitance				-55°C to +20°C : $0 \leq \frac{\Delta C}{C} \leq 3,75\%$ 20°C to 85°C : $-3,25\% \leq \frac{\Delta C}{C} \leq 0\%$
Temp. change Final measurements		Upper category temp. Capacitance Insulation resistance				R ins as in GENERAL DATA
4.13 Charge and discharge		10.000 cycles (1...50C/sec) $1,5 \times \left(\frac{dU}{dt} \right)$ charge to U_{Rdc} (with maximum pulse slope $\leq 0,01 \left(\frac{dU}{dt} \right)_R$) discharge with resistor defined by $R = \frac{U_{Rdc}}{C \left(\frac{dU}{dt} \right)_{1,5}} \frac{1,5}{R}$	3	9	1	

AC and pulse metallized polypropylene film capacitors

2222 378

Sub-clause number and Test (see Note 1)	D or ND	Conditions of test (see Note 1)	Sample size + criterion of accepta- bility (see Note 3)			Performance requirements
			p	n	c	
4.13.1 Initial measurements		Capacitance Tangent of loss angle for C < 1µF at 100kHz C > 1 µF at 10kHz				
4.13.3 Final measurements		Capacitance Tangent of loss angle Insulation resistance				$\frac{\Delta C}{C} \leq 1\%$ of value measured in A.7.1 Increase of tan delta <0,0005 for C < 100nF <0,001 for C > 100nF <470nF <0,0015 for C > 470nF compared with A.7.1 > 50% of values in GENERAL DATA of this specifi- cation.

AC and pulse metallized polypropylene film capacitors

2222 378

Additional tests	D or ND	Conditions of test	Sample size + criterion of acceptability			Performance requirements
			p	n	c	
<u>Sub-group ADD1</u>						
A.1. Solderability	D	Without ageing Methode : 1 Non-activated colophony flux 501 Solder bath : 235°C	3	35	1	Good tinning as evidenced by free flowing of the solder with wetting of the terminations
Solvent resistance of the marking		Mixture 1,1,2,-trichlorotrifluoroethane and 2-propanol (isopropylalcohol) Temp.: 48,6 to 50,5°C (boiling). Method 1 Rubbing material : cotton wool Immersion time : 5 +0,5 min.				Legible marking
<u>Sub-group ADD2</u>						
A.2 Heat storage		Duration : 2000h Temperature : upper category temperature	3	12	1	
A.2.1 Initial measurements		Capacitance Tangent of loss angle				
A.2.2 Final measurements		Capacitance Tangent of loss angle Insulation resistance.				$\frac{\Delta C}{C} < 1\%$ of value measured in A.2.1 Increase of $\tan \delta$ $< 0,0005$ for $C < 100nF$ $< 0,001$ for $C > 100nF$ $< 470nF$ $< 0,0015$ for $C > 470nF$ compared with A.2.1 As in GENERAL DATA of this specification.

AC and pulse metallized polypropylene film capacitors

2222 378

Additional tests	D or ND	Conditions of test	Sample size + criterion of accepta- bility			Performance requirements
			p	n	c	
<u>Sub-group ADD3</u>			3	9	1	
A.3 Detergent resistance		Density 20g/l Dishwasher detergent Temperature 70°C during 3 min. Followed by rinsing in clean water for 1 min. Recovery time 1±2h				
A.3.1 Initial measurements		Capacitance Tangent of loss angle				
A.3.2 Final measurements		Capacitance				$\frac{\Delta C}{C} < 1\%$ of value measured in A.3.1
		Tangent of loss angle				Increase of tan delta <0,0005 for C < 100nF <0,001 for C > 100nF <470nF <0,0015 for C > 470nF compared with A.3.1
		Insulation resistance				> 50% of values in GENERAL DATA of this specification.
<u>Sub-group ADD4</u>			6	15	1	
A.4 Resistance to solde- ring heat with pre- heating.	D	Capacitors mounted on a 1,6mm board with nonplated holes Body temp. : 80°C Bath temp. : 260°C Dwell time : 2x5s with interim free period of 5s.				
A.4.1 Initial measurements		Capacitance Tangent of loss angle After recovery of 24 h.				
A.4.2 Final measurements		Capacitance				$\frac{\Delta C}{C} < 1\%$ of value measured in A.4.1
		Tangent of loss angle				Increase of tan delta <0,0005 for C < 100nF <0,001 for C > 100nF <470nF <0,0015 for C > 470nF compared with A.4.1

AC and pulse metallized polypropylene film capacitors

2222 378

Additional tests	D or ND	Conditions of test	Sample size + criterion of accepta- bility			Performance requirements
			p	n	c	
<u>Sub-group ADD5</u>	D		6	15	1	
A.5.1 Needle flame test IEC 40 (secr.)580 Class C		Bore of gas jet : \varnothing 0,5mm Fuel : butane Test duration for actual volume V (mm ³) : $< 250 : 5$ s $250 < V < 500 = 10$ s $500 < V \leq 1750 = 20$ s $V > 1750 = 30$ s One flame applica- tion.				After removing the test flame from the capacitor, the ca- pacitor must not continue to burn for more than 30 s, no burning particle must drop from the sample.

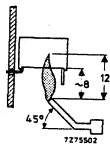

AC and pulse metallized polypropylene film capacitors

2222 378

Additional tests	D or ND	Conditions of test	Sample size + criterion of acceptability			Performance requirements
			p	n	c	
<hr/>						
<u>Sub-group ADD6</u>						
A.6 Endurance under sinusoidal voltage		Duration : 24 h Temperature : 23°C Voltage : 1,1x permissible voltage Frequency : 20 kHz	3	5	1	
A.6.2 Final measurements		Capacitor body temperature				$\Delta T < 15^\circ\text{C}$
<hr/>						
<u>Sub-group ADD7</u>	D		3	21	1	
A.7 Endurance						
A.7.1 Initial measurements		Capacitance Tangent of loss angle for $C < 1\mu\text{F}$ at 100kHz for $C > 1\mu\text{F}$ at 10kHz				
A.7.2 Endurance DC		Duration : 2000h 1,25 U_{Rdc} at 85°C				
A.7.3 Final measurements		Visual examination Capacitance Tangent of loss angle Insulation resistance.				No visible damage Legible marking $\frac{\Delta C}{C} < 1\%$ of value measured in A.7.1 Increase of $\tan \delta$ <0,0005 for $C < 100\text{nF}$ <0,001 for $C > 100\text{nF}$ <470nF <0,0015 for $C > 470\text{nF}$ compared with A.7.1 >50% of values in GENERAL DATA of this specification

AC and pulse metallized polypropylene film capacitors

2222 378

Additional tests	D or ND	Conditions of test	Sample size + criterion of accepta- bility			Performance requirements
			p	n	c	
<u>Sub-group ADD8</u> A.8 Climatic test on taped type		10 days at $40 \pm 2^\circ\text{C}$ R.H. 90 to 95% Recovery time : 24h	3	15	0	Change in position of lead hole over 20 pitch distances $< 0,5 \text{ mm.}$ Angle of component $< 4^\circ$ Pull out and tearing forces $> 50\%$ of values in GENERAL DATA of this specification

Precision

Philips Components

Data sheet	
status	Product specification
date of issue	May 1990

2222 424/425/426/**427/428/429/430/431****Polystyrene film/foil capacitors**

KS Axial sleeved types

* supplied loose in box and taped on reel

QUICK REFERENCE DATA

Capacitance range	47 to 39000 pF
Capacitance tolerance	<u>±</u> 5%, <u>±</u> 2%, <u>±</u> 1%
Rated voltage U _{Rdc}	63V, 160V, 250V, 630V
Climatic category	
63 V version	40/070/21
160 V, 250 V, 630 V versions	40/085/21
Rated temperature	
63 V version	70°C
160 V, 250 V, 630 V versions	85°C
Related specification	IEC 384-7
Stability class	Class 2

Polystyrene film/foil capacitors

2222 424/425/426/427/428/429/430/431

SURVEY OF STYLES

Style : 2222 424 to 427
See Tables 1 to 4

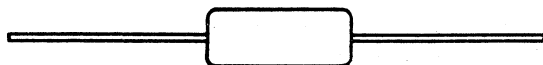

Style : 2222 428 to 431
See Tables 1 to 4

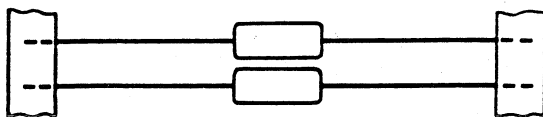

CONSTRUCTION

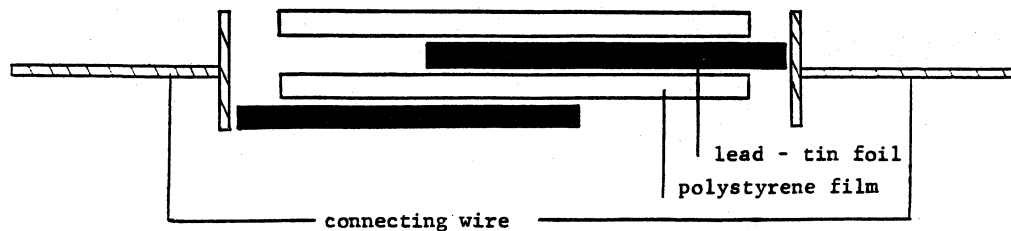

Polystyrene film/foil capacitors

2222 424/425/426/427/428/429/430/431

APPLICATION

For use in circuits where close tolerance, reliability and low losses are of prime importance, e.g. tuned circuits, filter networks, timing networks, etc.

DESCRIPTION

The capacitors consist of a low-inductive wound cell of metal foil and a polystyrene film. The cell is covered with a green plastic sleeve. The axial leads are of solder-coated wire.

1. GENERAL DATA

1.1. MountingNormal use

The capacitors are suitable for vertical or horizontal mounting on printed-wiring boards.

When soldering, the body temperature shall not exceed 100°C.

The capacitors packed in bandoliers are designed for mounting on printed-wiring boards by means of automatic insertion machines.

Soldering conditions :

The capacitance stability is dependent on the body dimensions and a function of soldering temperature, soldering time, preheating, mounting method, mounting height and mounting pitch.

In all of the following graphs the solder bath temperature is $260 \pm 5^\circ\text{C}$.

Fig. below shows the typical behaviour of $\Delta C/C$ with and without preheating as a function of soldering time. Preheating temperature is 80°C (duration of 1 hour). Mounting is directly on to the printed circuit board.

The leads are to be kept as short as possible (shortest pitch).

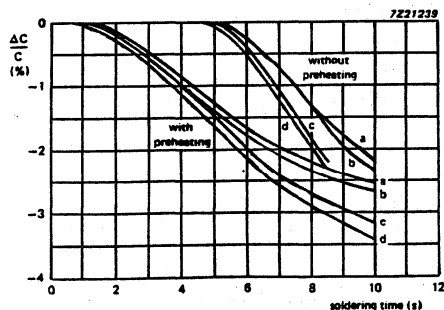

a = 1100 pF : 160 V
 b = 2000 pF : 63 V
 c = 560 pF : 250 V
 d = 51 pF : 630 V

Typical effect on $\Delta C/C$ with and without preheating (worst case mounting)

Polystyrene film/foil capacitors

2222 424/425/426/427/428/429/430/431

Figure below shows the typical effect of higher mounting and minimum pitch, with and without preheating.

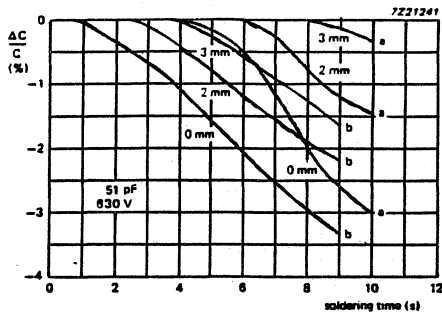

a : without preheating

b : with preheating

Typical effect of mounting height with and without preheating.

Figure below shows the effect of a wider mounting pitch and close mounting to the printed circuit board with preheating of the capacitor.

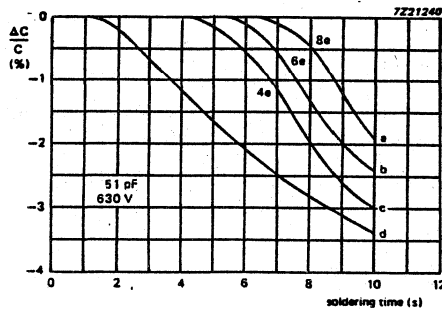

a,b,c : horizontal mounting

d : vertical mounting

Typical effect of wider mounting pitch and preheating.

Specific method of mounting to withstand vibration and shock

The capacitors shall be mechanically fixed by the leads.

Polystyrene film/foil capacitors

2222 424/425/426/427/428/429/430/431

1.2.1 Dimensions in mm

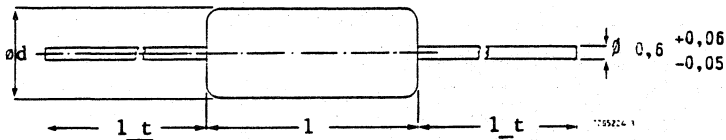

Fig. 1

Table 1 $U_{Rdc} = 63V$; max. a.c. voltage = 25V

capacitance (E24-series, C-tol+5%)* pF	d_max	l_max	l_t min	appr mass g	catalogue number	
					loose in box Fig. 1 2222 424 2....	taped on reel Fig. 2 2222 428 6....
2000				0,3		2002
2200	3,8					2202
2400						2402
2700						2702
3000				0,4		3002
3300	4,0	11	30			3302
3600						3602
3900						3902
4300						4302
4700				0,5		4702
5100	4,5					5102
5600						5602
6200						6202
6800				0,6		6802
7500	5,0					7502
8200						8202
9100				0,7		9102
10000		15	28			1003
11000				0,8		1103
12000	5,5					1203
13000				0,9		1303
15000						1503
16000				1,1		1603
18000	6,0					1803
20000						2003
22000	6,5			1,3		2203
24000				1,4		2403
27000	7,0			1,5		2703
30000				1,7		3003
33000	7,5			1,9		3303
36000						3603
39000	8,0			2,0		3903

* The capacitance values quoted are also available with a tolerance $\pm 2\%$ or $\pm 1\%$. Besides the values of the E24-series as quoted, intermediate values of the E48-series (with a tolerance $\pm 2\%$ or $\pm 1\%$) and of the E96-series (with a tolerance $\pm 1\%$) are available. The specifications of these intermediate values are equal to the specifications of the next higher value of the E24-series.

Polystyrene film/foil capacitors

2222 424/425/426/427/428/429/430/431

Table 2 $U_{Rdc} = 160V$; max. a.c. voltage = 63V

capacitance (E24-series, C-to $\pm 5\%$)* pF	d_max	l_max	l_t min	appr mass g	catalogue number	
					loose in box Fig. 1 2222 425 2....	taped on reel Fig. 2 2222 429 6....
1100	3,8					1102
1200				0,3		1202
1300						1302
1500	4,0					1502
1600						1602
1800						1802
2000		11	30	0,4		2002
2200	4,5					2202
2400						2402
2700				0,5		2702
3000						3002
3300						3302
3600						3602
3900						3902
4300	5,0			0,6		4302
4700						4702
5100		15	28			5102
5600						5602
6200				0,7		6202
6800	5,5			0,8		6802
7500						7502
8200				0,9		8202
9100	6,0					9102
10000						1003
11000				1,1		1103
12000	6,5			1,2		1203
13000				1,3		1303
15000				1,4		1503
16000	7,0			1,5		1603

* The capacitance values quoted are also available with a tolerance $\pm 2\%$ or $\pm 1\%$.

Besides the values of the E24-series as quoted, intermediate values of the E48-series (with a tolerance $\pm 2\%$ or $\pm 1\%$) and of the E96-series (with a tolerance $\pm 1\%$) are available. The specifications of these intermediate values are equal to the specifications of the next higher value of the E24-series.

Polystyrene film/foil capacitors

2222 424/425/426/427/428/429/430/431

Table 3 $U_{Rdc} = 250V$; max. a.c. voltage = 125V

rated capacitance (E24-series, C-tol \pm 5%)* pF	d_max	l_max	l_t min	appr mass g	catalogue number	
					loose in box Fig. 1 2222 426 2....	taped on reel Fig. 2 2222 430 6...
560						5601
620	3,8			0,3		6201
680						6801
750						7501
820						8201
910	4,0	11	30			9101
1000				0,4		1002
1100						1102
1200	4,5					1202
1300						1302
1500				0,5		1502
1600						1602
1800						1802
2000						2002
2200						2202
2400				0,6		2402
2700	5,0					2702
3000						3002
3300		15	28			3302
3600						3602
3900				0,7		3902
4300						4302
4700	5,5			0,8		4702
5100						5102
5600	6,0			0,9		5602
6200						6202
6800	6,5			1,1		6802
7500						7502
8200	7,0			1,3		8202
9100						9102
10000	7,5			1,5		1003
11000				1,6		1103

* The capacitance values quoted are also available with a tol. \pm 2% or \pm 1%. Besides the values of the E24-series as quoted, intermediate values of the E48-series (with a tolerance \pm 2% or \pm 1%) and of the E96-series (with a tolerance \pm 1%) are available. The specifications of these intermediate values are equal to the specifications of the next higher value of the E24-series.

Polystyrene film/foil capacitors

2222 424/425/426/427/428/429/430/431

Table 4 $U_{Rdc} = 630V$; max. a.c. voltage = 250V

capacitance (E24-series, C-tol+5%)* pF	d_max	l_max	l_t min	appr mass g	catalogue number			
					loose in box		taped on reel	
					Fig. 1 2222 427 2....	Fig. 2 2222 431 6....		
47						4709		
51						5109		
56						5609		
62						6209		
68						6809		
75						7509		
82						8209		
91						9109		
100				0,2		1001		
110						1101		
120						1201		
130	3,8					1301		
150						1501		
160		11	30			1601		
180						1801		
200						2001		
220						2201		
240						2401		
270						2701		
300						3001		
330				0,3		3301		
360						3601		
390	4,0					3901		
430						4301		
470						4701		
510	4,5					5101		
560						5601		
620						6201		
680				0,4		6801		
750						7501		
820						8201		
910						9101		
1000						1002		
1100	5,0			0,5		1102		
1200						1202		

* The capacitance values quoted are also available with a tolerance $\pm 2\%$ or $\pm 1\%$.

Besides the values of the E24-series as quoted intermediate values of the E48-series (with a tolerance $\pm 2\%$ or $\pm 1\%$) and of the E96-series (with a tolerance $\pm 1\%$) are available. The specifications of these intermediate values are equal to the specifications of the next higher value of the E24-series.

Polystyrene film/foil capacitors 2222 424/425/426/427/428/429/430/431

Table 4 $U_{Rdc} = 630V$; max. a.c. voltage = 250V

capacitance (E24-series, C-tol $\pm 5\%$)* pF	d_max	l_max	l_t min	appr mass g	catalogue number	
					loose in box Fig. 1 2222 427 2....	taped on reel Fig. 2 2222 431 6....
1300				0,6		1302
1500	5,0					1502
1600				0,7		1602
1800				0,8		1802
2000	5,5					2002
2200				0,9		2202
2400						2402
2700	6,0	15	28	1,1		2702
3000	6,5					3002
3300						3302
3600	7,0			1,4		3602
3900						3902
4300	7,5					4302
4700				1,7		4702
5100	8,0					5102
5600				2,0		5602

* The capacitance values quoted are also available with a tolerance $\pm 2\%$ or $\pm 1\%$.

Besides the values of the E24-series as quoted intermediate values of the E48-series (with a tolerance $\pm 2\%$ or $\pm 1\%$) and of the E96-series (with a tolerance $\pm 1\%$) are available. The specifications of these intermediate values are equal to the specifications of the next higher value of the E24-series.

Polystyrene film/foil capacitors

2222 424/425/426/427/428/429/430/431

1.2.2 Packing

The capacitors are supplied loose in box and taped on reel, details of quantities are given in Tables 5 and 6.

Loose in box

Table 5 : Number of capacitors per box.

capacitance values (pF) of				number of capacitors per box	
63V version	160V version	250V version	630V version	SPQ	PQ
2000- 3900	1100- 1800	560- 1000	47- 430	400	2400
4300- 5600	2000- 2700	1100- 1500	470- 680	300	1800
6200- 6800	3000- 3900	1600- 2200	750-1000	250	1500
			1100-1200	200	1200
7500-10000	4300- 6200	2400- 4300	1300-1500	300	1800
11000-20000	6800-10000	4700- 6200	1600-2700	250	1500
22000-24000	11000-13000	6800- 7500	3000-3300	200	1200
27000-39000	15000-16000	8200-11000	3600-5600	150	900

Taped on reel

1. Dimensions of taped products

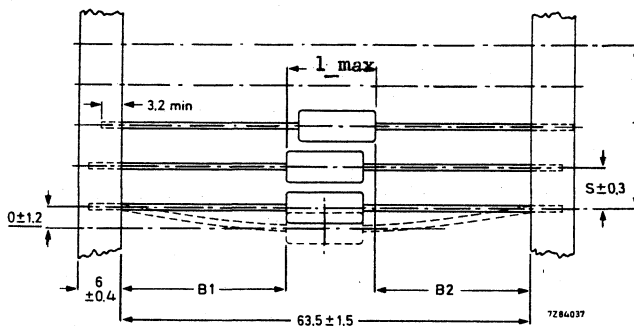

Fig. 10 $|B1-B2| = \max. 1,4\text{mm}$, for dimension l_{max} see tables 1 to 4

capacitance values (pF) of				S	T for number (n) of capacitors	
63V version	160V version	250V version	630V version		$n < 50$	$50 < n < 100$
2000- 5600	1100- 2700	560- 1500	47- 680	5	$5(n-1) + 2$	$5(n-1) + 4$
6200-39000	3000-16000	1600-11000	750-5600	10	$10(n-1) \pm 2$	$10(n-1) \pm 4$

Polystyrene film/foil capacitors

2222 424/425/426/427/428/429/430/431

2. Characteristics of taped products

Pull-out force of the component
Tearing force of tape

> 2 N
> 10 N

Storage conditions :

Storage temperature range
Relative humidity

-25°C to +40°C
max. 80% without condensation

3. Outlines of reel packing

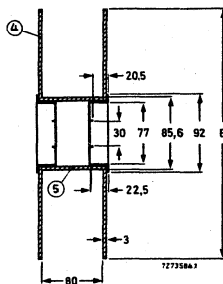
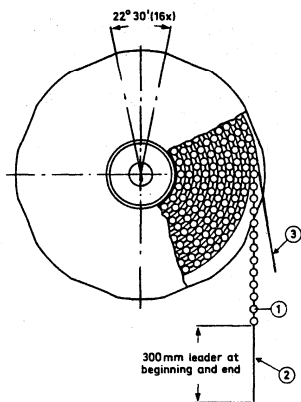

1 : capacitor 4 : flange
2 : bandolier 5 : cylinder
3 : paper

4. Number of capacitors per reel

Table 6

capacitance values (pF) of				B	number of capacitors on one reel
63V version	160V version	250V version	630V version		
2000- 2400	1100	560- 680	47- 300	305	3000
2700- 5600	1200- 2700	750- 1500	330- 680	305	2500
6200-20000	3000-10000	1600- 6200	750-2700	356	1500
22000-39000	11000-16000	6800-11000	3000-5600	356	1000

Polystyrene film/foil capacitors

2222 424/425/426/427/428/429/430/431

1.3.2 Voltage

Rated voltage U_{Rdc}	see Tables 1 to 4
Category voltage U_C	U_{Rdc}
Test voltage	
between terminations	$2 \times U_{Rdc}$
between interconnected terminations and case (foil method)	$2 \times U_{Rdc}$; min. 400 V
max. a.c. voltage (r.m.s. value), at 50 to 60 Hz	see Tables 1 to 4

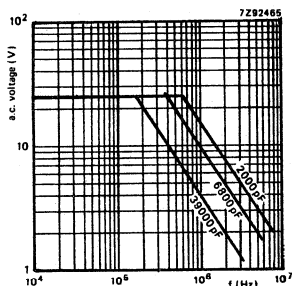

Fig. 3 Maximum a.c. voltage (r.m.s. value) as a function of frequency at $T_{amb} \leq 55^\circ C$, for 63 V version.

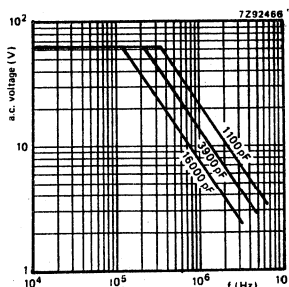

Fig. 4 Maximum a.c. voltage (r.m.s. value) as a function of frequency at $T_{amb} \leq 70^\circ C$, for 160 V version.

Polystyrene film/foil capacitors

2222 424/425/426/427/428/429/430/431

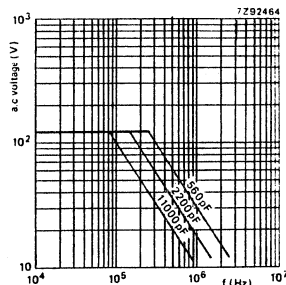

Fig. 5 Maximum a.c. voltage (r.m.s. value) as a function of frequency at $T_{amb} \leq 70^{\circ}C$, for 250 V version.

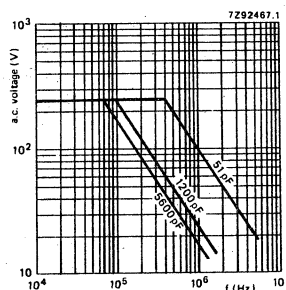

Fig. 6 Maximum a.c. voltage (r.m.s. value) as a function of frequency at $T_{amb} \leq 70^{\circ}C$, for 630 V version.

1.3.3 Climatic category

63V version	40/070/21
160V, 250V, 630V versions	40/085/21

1.3.4 Rated temperature

63V version	-40 to +70°C
160V, 250V, 630V versions	-40 to +85°C

1.3.5 Storage conditions

Temperature -25°C to +40°C
RH max. 80% without condensation

Polystyrene film/foil capacitors

2222 424/425/426/427/428/429/430/431

1.3.6 Tangent of loss angle

capacitance	tangent of loss angle		
	at 1 kHz	at 100 kHz	at 1 MHz
$C < 1000 \text{ pF}$	$< 5 \times 10^{-4}$	-	$\leq 10 \times 10^{-4}$
$1000 \text{ pF} < C \leq 10000 \text{ pF}$	$\leq 5 \times 10^{-4}$	$< 10 \times 10^{-4}$	-
$10000 \text{ pF} < C \leq 20000 \text{ pF}$	$\leq 5 \times 10^{-4}$	$\leq 15 \times 10^{-4}$	-
$C > 20000 \text{ pF}$	$\leq 5 \times 10^{-4}$	$\leq 25 \times 10^{-4}$	-

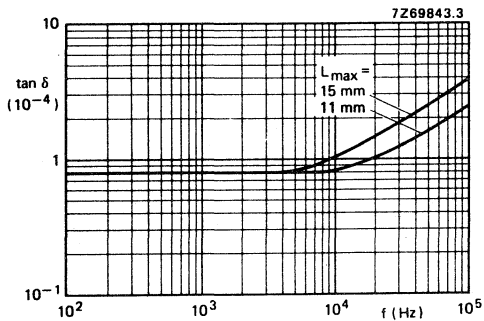

Fig. 7 : Tan_delta as a function of frequency; typical curve

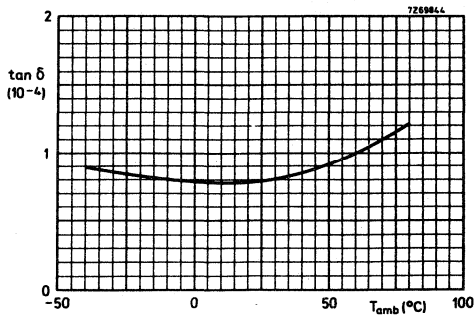

Fig. 8 : Tan_delta as a function of ambient free air temperature; typical curve

Polystyrene film/foil capacitors

2222 424/425/426/427/428/429/430/431

1.3.7 Insulation resistance at $T_{amb. 20^{\circ}C}$.

The insulation resistance is measured after a voltage has been applied for 1 min. \pm 5 s., the voltage being 10 \pm 1 V for the 63 V version 100 \pm 15 V for the 160 V and 250 V versions and 500 \pm 50 V for the 630 V version.

R between terminations $> 100.000 M\Omega$

R between interconnected terminations and case $> 100.000 M\Omega$

Inductance $\leq 10nH/cm$ lead and cap. length

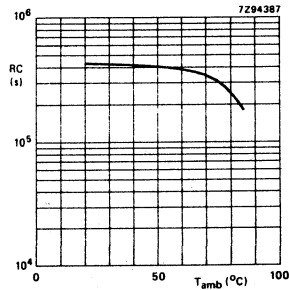
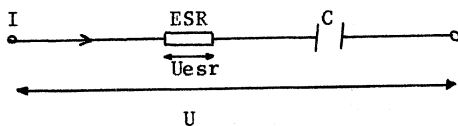

Fig. 9 : RC-product as a function of ambient free air temperature; typical curve.

1.3.8 Maximum dissipation

The power dissipated by a capacitor is a function of the voltage U_{esr} across or the current I through the series resistance ESR and is expressed by:

$$P = \frac{U_{esr}^2}{ESR} \quad (1) \quad \text{or } P = ESR \cdot I^2 \quad (2)$$



$$U_{esr}^2 = \frac{ESR^2}{ESR^2 + 1/w^2C^2} \cdot U^2 \quad (3a)$$

As for film capacitors $\tan_{\Delta} = w.C.ESR \ll 0,1$, the formula (3a) can be simplified to

$$U_{esr}^2 = ESR^2 \cdot w^2 \cdot C^2 \cdot U^2 \quad (3b)$$

or with $ESR = \tan_{\Delta}/wC$, we become:

$$P = w.C.\tan_{\Delta}.U^2 \quad (4) \quad \text{or } P = \frac{\tan_{\Delta}}{w.C} I^2 \quad (5)$$

For the \tan_{Δ} we can take the value found from fig.7, C is in farad and $w = 2.\pi.f$.

U or I are assumed to be known.

The maximum permissible power dissipation (P_{max}), which depends on the dimensions of the capacitor and on the ambient free air temperature can be found from fig.10.

In applications where sine waves occur, we have to take for U the RMS-voltage or for I the RMS-current of the sine wave.

In applications where periodic signals occur, the signal has to be expressed in Fourier-terms:

$$U = U_0 + \sum_{k=1}^{\infty} \sin(kwt + \varphi_k) \quad (6)$$

Polystyrene film/foil capacitors

2222 424/425/426/427/428/429/430/431

$$I = \sum_{k=1}^{\infty} I_k \sin(k\omega t + \varphi_k) \quad (7)$$

with U_0 the D.C.voltage, U_k and I_k the voltage resp. of the k-th harmonic.

We become for the dissipated power :

$$\text{with (6)} \quad P = \sum_{k=1}^{\infty} k \cdot w \cdot C \cdot \tan_{\Delta k} \frac{U_k^2}{2} \quad (8)$$

$$\text{with (7)} \quad P = \sum_{k=1}^{\infty} \frac{\tan_{\Delta k} \cdot I_k^2}{k \cdot w \cdot C \cdot 2} \quad (9)$$

and $\tan_{\Delta k}$ is the \tan_{Δ} at the k-th harmonic.

curve	dimensions(mm)	
	d_max	l_max
1	3,8	11,0
2	4,0	11,0
3	4,5	11,0
4	5,0	11,0
5	5,0	15,0
6	5,5	15,0
7	6,0	15,0
8	6,5	15,0
9	7,0	15,0
10	7,5	15,0
11	8,0	15,0

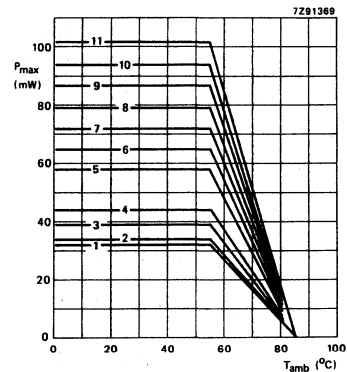
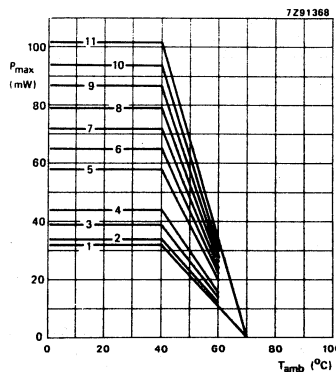

Fig. 10 Maximum permissible power dissipation as a function of ambient free air temperature.

* At $T_{amb} < 70^{\circ}C$ ($< 55^{\circ}C$ for 63V version) the maximum permissible sinusoidal voltage can be found in figs. 3, 4, 5 and 6.

Polystyrene film/foil capacitors

2222 424/425/426/427/428/429/430/431

1.3.10 Application note

To select this capacitor for a certain application you have to check 5 conditions

1. The peak voltage (U_p) shall not be greater than the rated d.c. voltage.
2. The peak to peak voltage (U_{pp}) shall not be greater than $2\sqrt{2}$ times the rated a.c. voltage to avoid the ionisation inception level.
3. There is no limit for the peak current (I_p) or voltage pulse slope (dU/dt) in the application.
4. The dissipated power shall not be greater than the maximum permissible power dissipation stated in 1.3.8.
5. The free air ambient temperature for the capacitor is not exceeding the category temperature.

Polystyrene film/foil capacitors**2222 424/425/426/427/428/429/430/431**

Example : C = 2nF used for the following voltage signal

A sinewave signal with an a.c. voltage of 100V at 100kHz frequency.

The ambient temperature is 50°C.

Can a 2nf/250Vdc/160Vac be used for this application?

Checking the 5 conditions

1. The peak voltage $U_p = 140 (\sqrt{2} \times 100)$ is lower than 250Vdc.
2. The peak to peak voltage $280 U_{pp}$ is lower than 120Vac $2\sqrt{2} = 353 U_{pp}$
3. Because of the sinewave, we have not to check the pulse conditions.
4. The dissipated power is :

$$P = W.C. \tan_{\text{delta}} V^2 \quad (\tan_{\text{delta}} = 2,5 \cdot 10^{-4} \text{ from fig. 7})$$

$$= 2,77 \cdot 100000 \cdot 2 \cdot 10^{-9} \cdot 2,5 \cdot 10^{-4} \cdot (100)^2 = 3,1 \text{mW}$$

This is less than 58mW at 50°C for its dimensions
5,0 x 15,0 , seen in fig. 10.

5. The free air ambient temperature is 50°C, and lower than 85°C.

Polystyrene film/foil capacitors 2222 424/425/426/427/428/429/430/431

1.4. Related documents

Generic specification	IEC 384-1
Sectional specification	IEC 384-7

1.5. Marking

The capacitors are marked with black ink with the following information :

- ° Capacitance in pF or nF
- ° Capacitance tolerance F : $\pm 1\%$ G : $\pm 2\%$ J : $\pm 5\%$
- ° Rated voltage (e.g. 63)
- ° Code for dielectric material (KS)
- ° Production date code according to IEC 62, clause 5

Example : 9n1
 G 63
 KS ..

Polystyrene film/foil capacitors

2222 424/425/426/427/428/429/430/431

The package containing the capacitors is marked as follows

Data on label SPQ and PQ
(example)

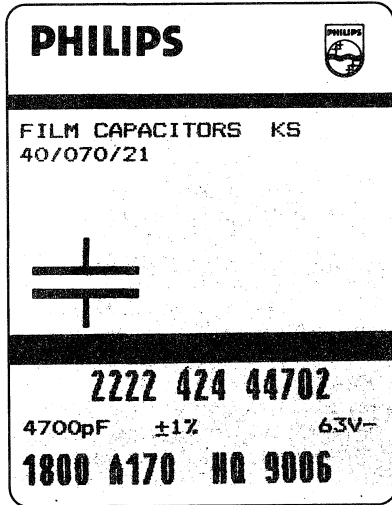

Block A : Philips word mark and emblem

Block B : Line 1 : Film capacitors and material code

Line 2 : Climatic group number

Capacitor symbol

Block C : Line 1 : Product code (12 NC)

Line 2 : Capacitance value in pF or μ F followed by pF or μ F
Tolerance followed by \pm and %
Voltage followed by V-

Line 3 : Number of capacitors
Preference-origin code : A
Country of origin : Belgium=170
Responsible production centre :
Philips Roeselare = HQ
Production period : year- and week code (4 digits)

1.6. Ordering information

Order the capacitors by quoting the 12-digit catalogue number as shown in Tables 1 to 4

Composition of the catalogue number

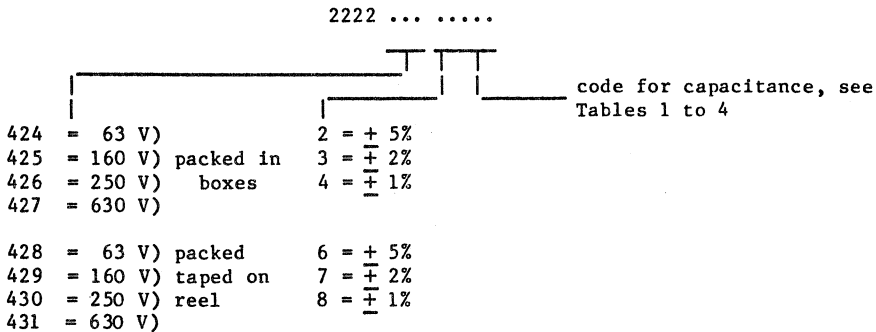

1.7. Certified test records (CTR)

Not required.

Polystyrene film/foil capacitors

2222 424/425/426/427/428/429/430/431

2. INSPECTION REQUIREMENTS

Note 1 : Sub-clause numbers of tests and performance requirements refer to the Sectional Specification, IEC-publication 384-7 and Section One of this specification.

Note 2 : Inspection levels and AQL's are selected from IEC-Publication 410 : Sampling Plans and Procedures for Inspection by attributes.

Note 3 : In this table :

- p = periodicity (in months)
- n = sample size
- c = acceptance criterion (permitted number of defectives)
- D = destructive
- ND = non-destructive
- IL = inspection level) IEC 410
- AQL = acceptable quality level)

Note 4 : For this capacitor, considered as a solid construction, it is permitted to reduce the periodicity of the vibration and shock test from 6 months to 36 months.
In the event of a single defective occurring in subgroup Clb at this reduced rate of testing, then the vibration and shock tests shall revert to a 6 monthly periodicity until three successive 6-monthly tests shall have produced no defectives.

Polystyrene film/foil capacitors

2222 424/425/426/427/428/429/430/431

Clause number and Test (see Note 1)	D or ND	Conditions of Test (see Note 1)	IL (see Note 2)	AQL	Performance requirements (see note 1)
<u>Group A Inspection</u> (lot-by-lot)					
<u>Sub-group A1</u>	ND		I	2,5%	
4.1 Visual examination					- No mechanical failures - Legible marking and as specified in GENERAL DATA of this specification.
4.2 Dimensions		Gauging			- As specified in Tables 1 to 4 of this specification.
<u>Sub-group A2</u>	ND		I	1%	
4.2.1 Voltage proof (Test A)		at $2 \times U_{Rdc}$ for 1 s.			- No breakdown or flashover
4.2.2 Capacitance		at 1 kHz			- Within specified tolerance
4.2.3 Tangent of loss angle		$C < 1000\text{pF}$ at 1 MHz $C > 1000\text{pF}$ at 100kHz			- As in GENERAL DATA of this specification.

Polystyrene film/foil capacitors

2222 424/425/426/427/428/429/430/431

Sub-clause number and Test (see Note 1)	D or ND	Conditions of test (see Note 1)	Sample size + criterion of accepta- bility (see Note 3)			Performance requirements
			p	n	c	
<u>Group C inspection</u> (periodic) (see Note 4)						
<u>Sub-group C1A</u> Part of sample of Sub-group C1	D		6	9	1	
4.1 Dimensions (detail)						As specified in GENERAL DATA
4.3.1 Initial measurements		Capacitance for C < 1000pF at 100 kHz C > 1000pF at 1 kHz Tangent of loss angle for C < 1000pF at 1 MHz C > 1000pF at 100 kHz				
4.3 Robustness of terminations		Tensile Bending Torsion				No visible damage
4.4 Resistance to soldering heat		No pre-drying Methode : 1A Solder bath : 260°C Duration : 5 s				
4.4.2 Final measurements		Visual examination Capacitance Tangent of loss angle				No visible damage Legible marking $\frac{\Delta C}{C} \leq 1\% + 1pF$ for C < 1000pF $\leq 1\%$ for C > 1000pF of the value measured in 4.3.1 As in GENERAL DATA of this specifi- cation.

Polystyrene film/foil capacitors 2222 424/425/426/427/428/429/430/431

Sub-clause number and Test (see Note 1)	D or ND	Conditions of test (see Note 1)	Sample size + criterion of accepta- bility (see Note 3)			Performance requirements
			p	n	c	
<u>Sub-group ClB</u> Other part of sample of Sub-group Cl	D		6	18	1	
4.6.1 Initial measurements		Capacitance for C < 1000pF at 100 kHz C > 1000 pF at 1 kHz Tangent of loss angle for C < 1000pF at 1 MHz C > 1000pF at 100 kHz				
4.6 Rapid change of of temperature		θA=lower cat. temp. θB=upper cat. temp. Five cycles Duration t = 30min. Recovery 1 to 2h				
4.6.2 Intermediate measurements		Visual examination Capacitance Tangent of loss angle				No visible damage $\frac{\Delta C}{C} \leq 0,5\% + 0,5pF$ for C < 1000pF $\leq 0,5\%$ for C > 1000pF As in GENERAL DATA of this specifi- cation.
4.7 Vibration (see Note 4)		Method of mounting see GENERAL DATA of this specification. Procedure B4. Frequency range : 10Hz to 55Hz. Amplitude 0,75mm or acceleration 98m/s ² (whichever is the less severe) Total duration 6h				
4.7.2 Final inspection Intermediate measurement		Visual examination Capacitance				No visible damage $\frac{\Delta C}{C} \leq 0,5\% + 0,5pF$ for C < 1000pF $\leq 0,5\%$ for C > 1000pF of the value measured in 4.6.2

Polystyrene film/foil capacitors

2222 424/425/426/427/428/429/430/431

Sub-clause number and Test (see Note 1)	D or ND	Conditions of test (see Note 1)	Sample size + criterion of accepta- bility (see Note 3)			Performance requirements
			p	n	c	
4.9 Shock (see Note 4)		Method of mounting see GENERAL DATA of this specification Accelerat.: 490m/s ² Duration of pulse : 11ms				
4.9.3 Final measurements		Visual examination Capacitance				No visible damage $\frac{\Delta C}{C} < 0,5\% +0,5pF$ for $C < 1000pF$ $< 0,5\%$ for $C > 1000pF$ of the value measured in 4.7.2
<u>Sub-group C1</u> Combined sample of specimens of Sub- groups C1A and C1B	D		6	27	2	
4.10 Climatic sequence						
4.10.2 Initial measurements		Capacitance for C < 1000pF at 100 kHz C > 1000 pF at 1 kHz Tangent of loss angle for C < 1000pF at 1 MHz C > 1000pF at 100 kHz Insulation resistance				
4.10.3 Dry heat		Temperature : upper category temperature Duration : 16h				
4.10.4 Damp heat cyclic, Test Db, first cycle						
4.10.5 Cold		Temperature : lower category temperature Duration : 2h				
4.10.7 Damp heat cyclic, Test Db remaining cycle		Recovery 1 to 2 h.				

Polystyrene film/foil capacitors

2222 424/425/426/427/428/429/430/431

Sub-clause number and Test (see Note 1)	D or ND	Conditions of test (see Note 1)	Sample size + criterion of accepta- bility (see Note 3)			Performance requirements
			p	n	c	
4.10.7.2 Final measurements		Visual examination Capacitance Tangent of loss angle Insulation resis- tance				No visible damage Legible marking $\frac{\Delta C}{C} < 1\% + 1pF$ for $C < 1000pF$ $< 1\%$ for $C > 1000pF$ of the value measured in 4.10.2 $Tan\ \delta < 2$ value specified in GENERAL DATA of this specification >50% of values in GENERAL DATA of this specification
Sub-group C2 4.11 Damp heat steady state 4.11.1 Initial measurements	D	Capacitance for $C < 1000pF$ at 100 kHz $C > 1000pF$ at 1 kHz Tangent of loss angle for $C < 1000pF$ at 1 MHz $C > 1000pF$ at 100kHz	6	15	1	
4.11.3 Final measurements		Recovery 1 to 2 h. Visual examination Capacitance Tangent of loss angle Insulation resistance				No visible damage Legible marking $\frac{\Delta C}{C} < 1\% + 1pF$ for $C < 1000pF$ $< 1\%$ for $C > 1000\ pF$ of the value measured in 4.11.1 $Tan\ \delta < 2$ value specified in GENERAL DATA of this specification >50% of values in GENERAL DATA of this specification

Polystyrene film/foil capacitors

2222 424/425/426/427/428/429/430/431

Sub-clause number and Test (see Note 1)	D or ND	Conditions of test (see Note 1)	Sample size + criterion of accepta- bility (see Note 3)			Performance requirements
			p	n	c	
<u>Sub-group C3</u>	D		3	21	1	
4.12 Endurance		Duration : 1000 h. 1,5 U Rdc at 70°C for 63V version at 85°C for 160V, 250V, 630V versions				
4.12.1 Initial measurements		Capacitance for C < 1000pF at 100 kHz C > 1000pF at 1 kHz Tangent of loss angle for C < 1000pF at 1 MHz C > 1000pF at 100kHz				
4.12.5 Final measurements		Visual examination Capacitance Tangent of loss angle Insulation resistance				No visible damage Legible marking 63V version $\frac{\Delta C}{C} < 0,3 \%$ 160V, 250V, 630V versions $< 0,5\% + 0,5pF$ for $\bar{C} < 1000pF$ $< 0,5\%$ for $\bar{C} > 1000 pF$ of the value measured in 4.12.1 As in GENERAL DATA of this specification or $\leq 1,4$ value measured in 4.12.1 whichever is greater As in GENERAL DATA of this specifi- cation.

Polystyrene film/foil capacitors

2222 424/425/426/427/428/429/430/431

Sub-clause number and Test (see Note 1)	D or ND	Conditions of test (see Note 1)	Sample size + criterion of accepta- bility (see Note 3)			Performance requirements
			p	n	c	
<u>Sub-group C4</u>	D		12	9	1	
4.2.5 Variation of capacitance with temperature		Static method The capacitors shall be dried Number of cycles :1				Temp. coeff. as in GENERAL DATA of this specification
		Capacitance measurements for C < 1000pF at 100kHz C > 1000pF at 1 kHz				Temperature cyclic drift of capaci- tance $\frac{\Delta C}{C} < 0,5\% + 0,5pF$ for C < 1000pF $< 0,5\%$ for $\bar{C} > 1000 pF$
		Insulation resistance				> 10.000 MΩ
4.2.6 Inductance						As in GENERAL DATA of this specifi- cation.

Polystyrene film/foil capacitors

2222 424/425/426/427/428/429/430/431

Additional tests	D or ND	Conditions of test	Sample size + criterion of accepta- bility			Performance requirements
			p	n	c	
<hr/>						
<u>Sub-group ADD1</u> A.1 Solderability	D	Without ageing Method : 1 Non-activated colo- phany flux 501 Solder bath 235°C Dwell time : 2 s.	3	35	1	Good tinning as evidenced by free flowing of the solder with wet- ting of the ter- minations (>95%)
<hr/>						
<u>Sub-group ADD2</u> A.2 Heat storage	D	Duration : 1000h Temperature : upper category temperature	3	21	1	
A.2.1 Initial measurements		Capacitance for C < 1000pF at 100 kHz C > 1000pF at 1 kHz Tangent of loss angle for C < 1000pF at 1 MHz C > 1000pF at 100 kHz				
A.2.2 Final measurements		Capacitance Tangent of loss angle Insulation resistance				63V version $\frac{\Delta C}{C} < 0,3\%$ 160V, 250V, 630V versions for C < 1000pF $< 0,5\% + 0,5pF$ for C > 1000 pF $< 0,5\%$ of the value measured in A.2.1 As in GENERAL DATA of this specifi- cation or < 1,4 value measured in A.2.1 whichever is greater. As in GENERAL DATA of this specifi- cation.

Polystyrene film/foil capacitors

2222 424/425/426/427/428/429/430/431

Additional tests	D or ND	Conditions of test	Sample size + criterion of acceptability			Performance requirements
			p	n	c	
Sub-group ADD3						
A.3 Endurance for capacitors with max. a.c. voltage $\geq 200V$ r.m.s.		Duration : 1000h Temperature : 70°C for 63V version 85°C for 160V, 250V, 630V versions Voltage: 1,25xmax. a.c. voltage (r.m.s. value), 50Hz	3	21	1	
A.3.1 Initial measurements		Capacitance for C < 1000pF at 100 kHz C > 1000pF at 1 kHz Tangent of loss angle for C < 1000pF at 1 MHz C > 1000pF at 100 kHz				
A.3.2 Final measurements		Capacitance				63V version $\frac{\Delta C}{C} < 0,3\%$ 160V, 250V, 630V versions for C < 1000pF $< 0,5\% + 0,5pF$ for C > 1000 pF $< 0,5\%$ of the value measured in A.3.1 As in GENERAL DATA of this specification or $\leq 1,4$ value measured in A.3.1 whichever is greater.
		Tangent of loss angle				As in GENERAL DATA of this specification.
		Insulation resistance				As in GENERAL DATA of this specification.
Sub-group ADD4						
A.4 Climatic test on taped type		10 days at 40 + 2°C R.H. 90 to 95 % Recovery time : 24h	3	5	0	Deviation tape on a strip of 250 mm taped products $< 2\%$ Pull out and tearing force $> 50\%$ of values in GENERAL DATA of this specification.

Philips Components

Data sheet	
status	Products specification
date of issue	May 1990

2222 460/461/462/463/464

Polypropylene film/foil capacitors

KP Axial epoxy lacquered types

° supplied loose in box, taped on reel or unidirectional.

QUICK REFERENCE DATA

Capacitance range	47 to 62000 pF
Capcitanace tolerance	+5% (E24-series) ±2% (E24, E48-series) ±1% (E24, E48, E96-series)
Rated voltage U_{Rdc}	63V, 160V, 250V, 400V, 630V
Climatic category	40/100/56
Rated temperature	85°C
Related specification	IEC 384-13
Stability class for 63V, 160V and 250V versions for 400V and 630V versions	Class 1 Class 2

Polypropylene film/foil capacitors

2222 460/461/462/463/464

SURVEY OF STYLES



Style 2222 460 to 464
See tables 1 to 5

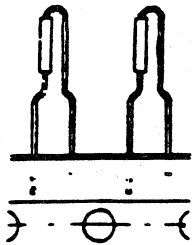
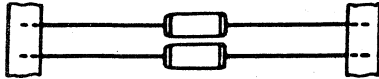

CONSTRUCTION

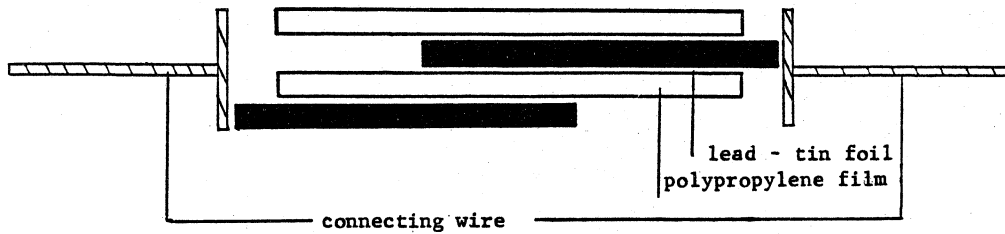

Polypropylene film/foil capacitors

2222 460/461/462/463/464

APPLICATION

For use in circuits where close tolerance, reliability and low losses are of prime importance, e.g. tuned circuits, filter networks, timing networks, etc.

DESCRIPTION

The capacitors consist of a low-inductive wound cell of metal foil and a polypropylene film. The cell is protected by a hard, water repellent solvent resistant blue epoxy lacquer. The long axial leads of solder-coated wire make the capacitors suitable for vertical or horizontal mounting on printed-wiring boards.

1. GENERAL DATA

1.1. Mounting

Normal use

The capacitors are suitable for vertical or horizontal mounting on printed-wiring boards.

The capacitors packed on bandoliers are designed for mounting on printed-wiring boards by means of automatic insertion machines.

Soldering conditions :

The capacitance stability is dependent on the maximum temperature the capacitor reaches during soldering.

Figure below shows the typical effect of $\Delta C/C$ as a function of soldering time under worst possible mounting conditions (horizontal against the PCB, minimum possible pitch) and with 80°C preheating.

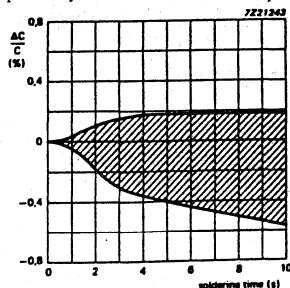

Typical effect of $\Delta C/C$ as a function of soldering time (boundaries of shaded area are the 2 - sigma limits).

Specific method of mounting to withstand vibration and shock

The capacitors shall be mechanically fixed by the leads.

Polypropylene film/foil capacitors

2222 460/461/462/463/464

1.2 Dimensions

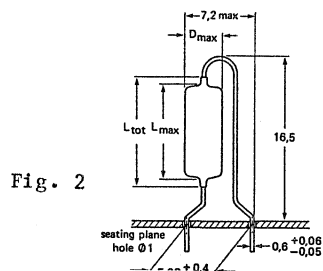
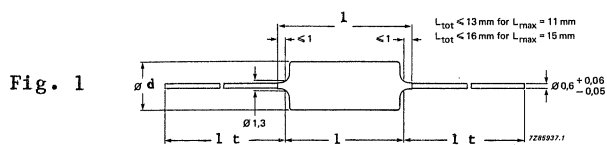

Table 1 $U_{Rdc} = 63V$; max. a.c. voltage = 40V, Fig. 1 and 2

capacitance (E-24 series) pF	d_max	l_max	l_t min	mass g	catalogue number 2222 460	
					loose in box or taped on reel Fig.1	unidirectional ** Fig.2
6800	5,0	11,0	30	0,5	6802	6802
7500					7502	7502
8200					8202	8202
9100					9102	9102
10000	5,5	15,0	28	0,7	1003	
11000					1103	
12000					1203	
13000					1303	
15000					1503	
16000					1603	
18000					1803	
20000					2003	
22000					2203	
24000					2403	
27000					2703	
30000					3003	
33000					3303	
36000					3603	
39000					3903	
43000					4303	
47000	4703					
51000	5103					
56000	5603					
62000	6203					

*The capacitance values quoted are available with a tolerance $\pm 5\%$, $\pm 2\%$ or $\pm 1\%$. Besides the values of the E24-series as quoted, intermediate values of the E48-series (with a tolerance $\pm 2\%$ or $\pm 1\%$) and the E96-series (with a tolerance $\pm 1\%$) are available.

The specifications of these intermediate values are equal to the specifications of the next higher value of the E24-series.

**The capacitance values quoted are available with a tolerance $\pm 2\%$ or $\pm 1\%$.

Polypropylene film/foil capacitors

2222 460/461/462/463/464

Table 2 $U_{Rdc} = 160V$; max. a.c. voltage = 63V, Fig. 1 and 2

capacitance (E24-series) pF	d_max	l_max	l_min	mass g	catalogue number 2222 461	
					loose in box or taped on reel Fig.1	unidirectional ** Fig.2
3600					3602	3602
3900					3902	3902
4300					4302	4302
4700					4702	4702
5100	5,0	11,0	30	0,5	5102	5102
5600					5602	5602
6200				0,6	6202	6202
6800				0,4	6802	
7500				0,7	7502	
8200					8202	
9100	5,5			0,6	9102	
10000					1003	
11000				0,7	1103	
12000					1203	
13000					1303	
15000		15,0	28	0,8	1503	
16000	6,0			0,9	1603	
18000					1803	
20000				1,0	2003	
22000	6,5			1,1	2203	
24000					2403	
27000	7,0			1,2	2703	
30000	7,5			1,3	3003	
33000				1,4	3303	
36000	8,0			1,5	3603	
39000				1,6	3903	

*The capacitance values quoted are available with a tolerance $\pm 5\%$, $\pm 2\%$ or $\pm 1\%$.

Besides the values of the E24-series as quoted, intermediate values of the E48-series (with a tolerance $\pm 2\%$ or $\pm 1\%$) and the E96-series (with a tolerance $\pm 1\%$) are available.

The specifications of these intermediate values are equal to the specifications of the next higher value of the E24-series.

**The capacitance values quoted are only available with a tolerance $\pm 2\%$ or $\pm 1\%$.

Polypropylene film/foil capacitors

2222 460/461/462/463/464

Table 3 $U_{Rdc} = 250V$; max. a.c. voltage = 125V, Fig. 1 and 2

capacitance (E24-series) pF	d_max	l_max	l_t mm	mass g	catalogue number 2222 462	
					loose in box or taped on reel Fig.1	unidirectional ** Fig.2
1200				0,5	1202	1202
1300					1302	1302
1500				0,4	1502	1502
1600				0,5	1602	1602
1800	5,0	11,0	30	0,6	1802	1802
2000					2002	2002
2200					2202	2202
2400					2402	2402
2700					2702	2702
3000				0,5	3002	3002
3300					3302	3302
3600					3602	
3900					3902	
4300	5,5				4302	
4700				0,6	4702	
5100					5102	
5600					5602	
6200					6202	
6800				0,7	6802	
7500		15,0	28		7502	
8200					8202	
9100	6,0			0,8	9102	
10000					1003	
11000				0,9	1103	
12000	6,5			1,0	1203	
13000					1303	
15000	7,0			1,1	1503	
16000				1,2	1603	
18000	7,5			1,3	1803	
20000	8,0			1,4	2003	
22000				1,5	2203	

*The capacitance values quoted are available with a tolerance $\pm 5\%$, $\pm 2\%$ or $\pm 1\%$.

Besides the values of the E24-series as quoted, intermediate values of the E48-series (with a tolerance $\pm 2\%$ or $\pm 1\%$) and the E96-series (with a tolerance $\pm 1\%$) are available.

The specifications of these intermediate values are equal to the specifications of the next higher value of the E24-series.

**The capacitance values quoted are only available with a tolerance $\pm 2\%$ or $\pm 1\%$.

Polypropylene film/foil capacitors

2222 460/461/462/463/464

Table 4 $U_{Rdc} = 400V$; max. a.c. voltage = 160V, Fig. 1 and 2

capacitance (E24-series) pF	d_max	l_max	l_t min	mass g	catalogue number 2222 463	
					loose in box or taped on reel Fig.1	unidirectional ** Fig.2
150				0,4	1501	1501
160					1601	1601
180				0,5	1801	1801
200					2001	2001
220					2201	2201
240				0,6	2401	2401
270					2701	2701
300				0,7	3001	3001
330				0,4	3301	3301
360					3601	3601
390	5,0	11,0	30		3901	3901
430					4301	4301
470					4701	4701
510					5101	5101
560					5601	5601
620				0,5	6201	6201
680					6801	6801
750					7501	7501
820					8201	8201
910					9101	9101
1000					1002	1002
1100					1102	1102

*The capacitance values quoted are available with a tolerance $\pm 5\%$, $\pm 2\%$ or $\pm 1\%$.

Besides the values of the E24-series as quoted, intermediate values of the E48-series (with a tolerance $\pm 2\%$ or $\pm 1\%$) and the E96-series (with a tolerance $\pm 1\%$) are available.

The specifications of these intermediate values are equal to the specifications of the next higher value of the E24-series.

**The capacitance values quoted are only available with a tolerance $\pm 2\%$ or $\pm 1\%$.

Polypropylene film/foil capacitors

2222 460/461/462/463/464

Table 5 $U_{Rdc} = 630V$; max. a.c. voltage = 200V, Fig. 1 and 2

rated capacitance (E24-series) pF	d_max	l_max	l_t min	mass g	catalogue number 2222 464	
					loose in box or taped on reel Fig.1	unidirectional ** Fig.2
47						4709
51						5109
56						5609
62						6209
68				0,4		6809
75	5,0	11,0	30			7509
82						8209
91						9109
100						1001
110						1101
120						1201
130				0,5		1301

*The capacitance values quoted are available with a tolerance $\pm 5\%$, $\pm 2\%$ or $\pm 1\%$.

Besides the values of the E24-series as quoted, intermediate values of the E48-series (with a tolerance $\pm 2\%$ or $\pm 1\%$) and the E96-series (with a tolerance $\pm 1\%$) are available.

The specifications of these intermediate values are equal to the specifications of the next higher value of the E24-series.

**The capacitance values quoted are available with a tolerance $\pm 2\%$ or $\pm 1\%$.

Polypropylene film/foil capacitors

2222 460/461/462/463/464

1.2.2 Packing

The capacitors are supplied loose in box, taped on reel or unidirectional.
Style on tape in ammunition packing available on request.

Loose in box

Table 6 : number of capacitors per box

capacitance values (pF) of					number per box	
63V version	160V version	250V version	400V version	630V version	SPQ	PQ
6800- 9100	3600- 6200	1200- 3300	150-1100	47-130	250	1500
10000-27000	6800-18000	3600-10000			250	1500
30000-36000	20000-24000	11000-13000			200	1200
39000-62000	27000-39000	15000-22000			150	900

Reel and ammunition packing

1. Dimensions of taped products

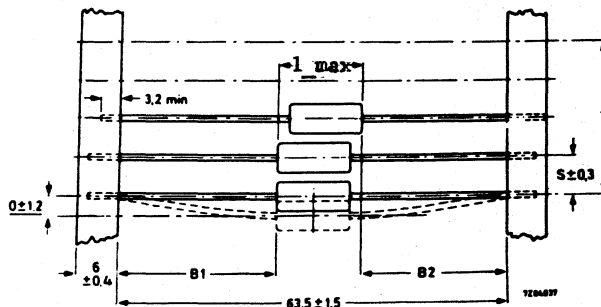

Fig. 3 |B1-B2| = max. 1,4 mm; for dimension 1_max see Tables 1 to 5

capacitance values (pF) of					S	T for number (n) of capacitors	
63V version	160V version	250V version	400V version	630V version		n < 50	50 < n < 100
6800- 9100	3600- 6200	1200- 3300	150 - 1100	47 - 130	5	5(n-1)+2	5(n-1)+4
10000-62000	6800-39000	3600-22000			10	10(n-1)+2	10(n-1)+4

Polypropylene film/foil capacitors

2222 460/461/462/463/464

Capacitors with radial leads

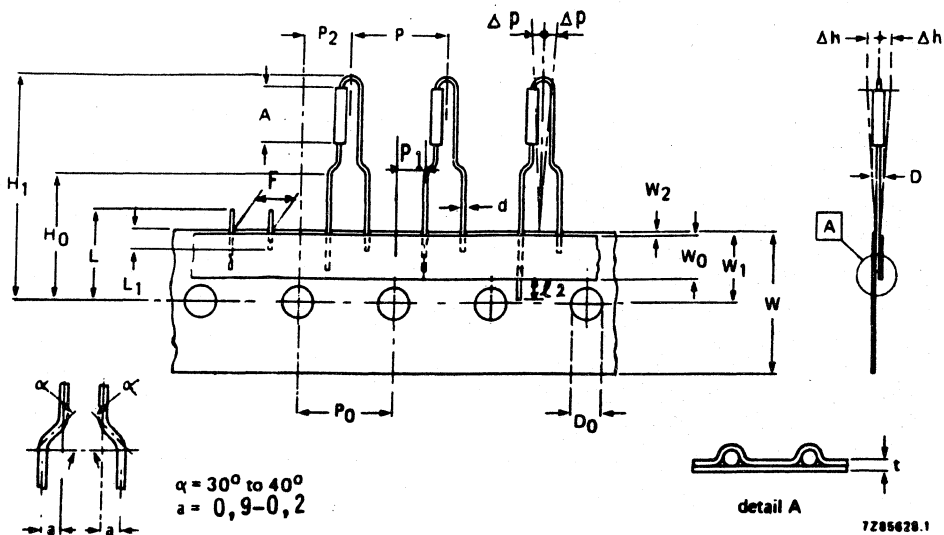

Pitch of components	P	12,7 + 1,0
Feed hole pitch	P ₀	12,7 ± 0,2
Cumulative pitch error	T	1,0 per 20 spacings 0,5 per 4 spacings
Feed hole centre to lead at top side at the tape	P ₁	3,85 + 0,5
Feed hole centre to body centre	P ₂	6,35 ± 1,0
Lead to lead distance	F	5,08 ± 0,4 - 0,2
Component alignment	Δh	0 + 1,2
Component alignment	Δp	+ 1,0
Tape width	W	18,0 + 0,5
Hold down tape width	W ₀	min. 5,5
Hole position	W ₁	9,0 ± 0,5
Hold-down tape position	W ₂	1 0,2
Lead wire clinch height	H ₀	16,0 ± 0,5
Component height	H ₁	max. 32
Feed hole diameter	D ₀	4,0 ± 0,2
Total tape thickness	t	0,7 ± 0,2
Length of snapped lead	L	max. 11,0
Lead wire (tape portion) shortest lead	L ₁	min. 2,0
Lead wire protrusion	l ₂	max. 4

Polypropylene film/foil capacitors

2222 460/461/462/463/464

2. Characteristics of taped products

For axial leads

Pull-out force of the component $\geq 2N$
 Pull-off force of adhesive tape $> 6N$
 Tearing force of tape $\geq 10N$

For radial leads

Pull-out force of the component $> 5N$
 Pull-off force of adhesive tape $\geq 6N$
 Tearing force of tape $\geq 15N$

Storage conditions

Storage temperature range $-25^{\circ}C$ to $+40^{\circ}C$
 Relative humidity max. 80% without condensation

3. Outlines of packing

3.1 Reel packing

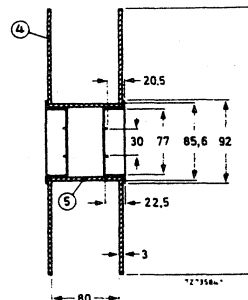
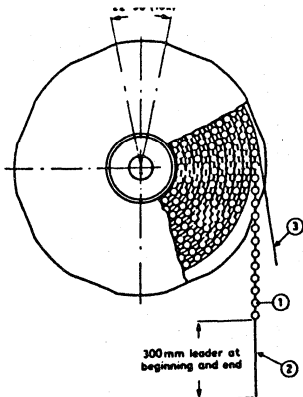

- 1 : capacitor
- 2 : bandolier
- 3 : paper
- 4 : flange
- 5 : cylinder

capacitance values (pF) of					B	number of capacitors on one reel
63V version	160V version	250V version	400V version	630V version		
6800-9100	3600-6200	1200-3300	150-1100	47-130	305	2500
10000-27000	6800-18000	3600-10000			356	1500
30000-62000	20000-39000	11000-22000			356	1000

Maximum 0,5% of the total number of capacitors per reel may be missing, but no more than 2 consecutive positions may be vacant.

Polypropylene film/foil capacitors

2222 460/461/462/463/464

3.2 Unidirectional

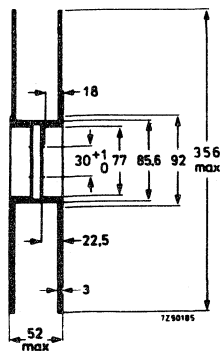
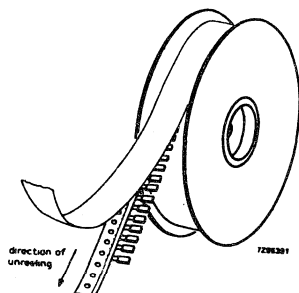

capacitance values (pF) of					B	number of capacitors on one reel
63V version	160V version	250V version	400V version	630V version		
6800- 9100	3600- 6200	1200- 3300	150-1100	47-130	356	

Polypropylene film/foil capacitors

2222 460/461/462/463/464

3.3 Ammunition packing

Style	M	N	P
1	97	155	265
2	97	135	265

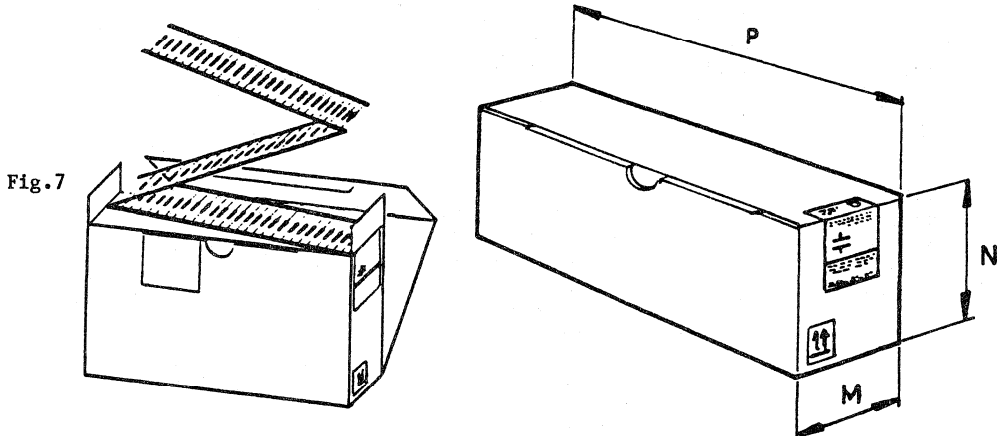

63V version	Capacitance value in pF			Number of capacitors in ammopack	style
	160V version	250/400/630V version			
6800 - 9100	3600 - 6200	47 - 3300		1500	1
10000 - 22000	6800 - 15000	3600 - 7500		1500	1
24000 - 27000	16000 - 18000	8200 - 10000		1000	1
30000 - 36000	20000 - 24000	11000 - 13000		750	2
39000 - 43000	27000	15000 - 16000		750	1
47000 - 51000	30000 - 33000	18000		500	2
56000 - 62000	36000 - 39000	20000 - 22000		500	2

Polypropylene film/foil capacitors

2222 460/461/462/463/464

1.3. Ratings and characteristics

Unless otherwise specified all electrical values apply to an ambient free air temperature of $23 \pm 1^\circ\text{C}$, an atmospheric pressure of 86 106kPa and a relative humidity of $50 \pm 2\%$.

1.3.1 Capacitance

Capacitance range at 1MHz for $C \leq 1000\text{pF}$ see tables 1 to 5
 at 1KHz for $C > 1000\text{pF}$

Capacitance tolerance $\pm 5\%$, $\pm 2\%$ or 2pF^*
 $\pm 1\%$ or 1pF^*

Temperature coefficient
 between -40 and $+20^\circ\text{C}$: for $C \leq 1000\text{pF}$ $-(125 \pm 125) 10^{-6}/\text{K}$
 for $C > 1000\text{pF}$ $-(125 \pm 60) 10^{-6}/\text{K}$
 between $+20$ and $+100^\circ\text{C}$ $-(250 \pm 120) 10^{-6}/\text{K}$

Capacitance dependence
 on frequency : none between 100Hz and 1MHz
 on temperature

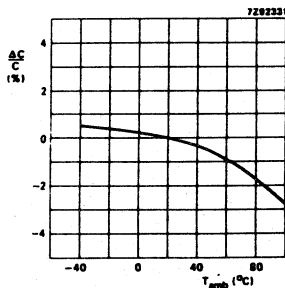

Fig. 8 : Capacitance as a function of ambient free air temperature : typical curve

* whichever is greater

Polypropylene film/foil capacitors

2222 460/461/462/463/464

1.3.2 Voltage.

Rated voltage U_{Rdc}	see Tables 1 to 5
Category voltage U_C	$0,8 \times U_{Rdc}$
Test voltage	
between terminations	$2 \times U_{Rdc}$
between interconnected terminations and case (foil method)	$2 \times U_{Rdc}$; min. 400 V
max. a.c. voltage (r.m.s. value) at 50 to 60 Hz	40V, 63V, 125V,160V,200V

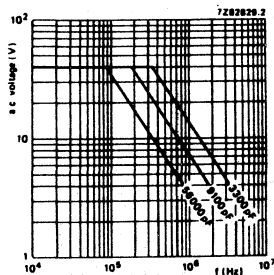

Fig. 9 Maximum a.c. voltage (r.m.s. value) as a function of frequency at $T_{amb} \leq 70^{\circ}C$, for $U_R = 63$ V.

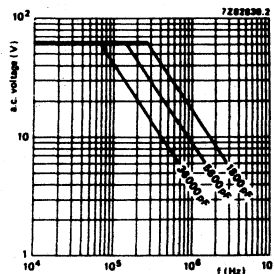

Fig. 10 Maximum a.c. voltage (r.m.s. value) as a function of frequency at $T_{amb} \leq 70^{\circ}C$, for $U_R = 160$ V.

Polypropylene film/foil capacitors

2222 460/461/462/463/464

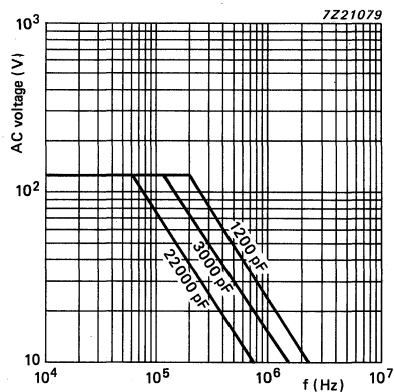

Fig. 11 Maximum a.c. voltage (r.m.s. value) as a function of frequency at $T_{amb} \leq 70^{\circ}C$, for $U_R = 250$ V.

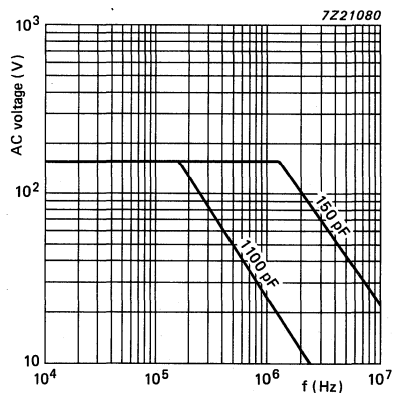
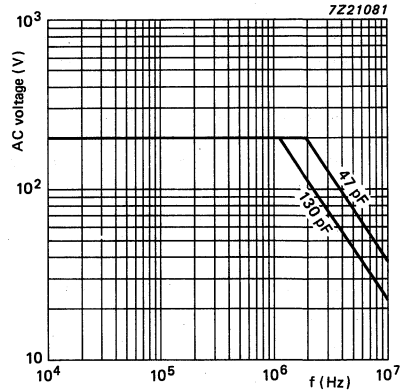

Fig. 12 Maximum a.c. voltage (r.m.s. value) as a function of frequency at $T_{amb} \leq 70^{\circ}C$, for $U_R = 400$ V.

Polypropylene film/foil capacitors

2222 460/461/462/463/464

Fig. 13 Maximum a.c. voltage (r.m.s. value as a function of frequency at $T_{amb} \leq 70^\circ\text{C}$, for $U_R = 630\text{ V}$.



1.3.3 Climatic category

40/100/56

1.3.4 Rated temperature

85°C

1.3.5 Storage temperature range

Temperature -25°C to $+40^\circ\text{C}$
RH max. 80% without condensation

1.3.6 Tangent of loss angle

capacitance	tangent of loss angle		
	at 1 kHz	at 100 kHz	at 1 MHz
$C < 1000\text{ pF}$	$< 5 \times 10^{-4}$	-	$\leq 10 \times 10^{-4} *$
$1000\text{ pF} < C < 5000\text{ pF}$	$< 5 \times 10^{-4}$	$< 10 \times 10^{-4}$	-
$5000\text{ pF} < C < 20000\text{ pF}$	$< 5 \times 10^{-4}$	$< 15 \times 10^{-4}$	-
$20000\text{ pF} < C < 47000\text{ pF}$	$< 5 \times 10^{-4}$	$< 25 \times 10^{-4}$	-
$C > 47000\text{ pF}$	$< 5 \times 10^{-4}$	$< 40 \times 10^{-4}$	-

* For unidirectional capacitors $< 13 \times 10^{-4}$

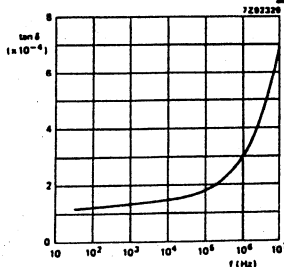

Fig.14 : \tan_{δ} as a function of frequency; typical curve.

Polypropylene film/foil capacitors

2222 460/461/462/463/464

1.3.7 Insulation resistance at Tamb 20°C.

The insulation resistance is measured after a voltage has been applied for 1 min. + 5 s., the voltage being 10V + 1 V for the 63 V version, 100V + 15 V for the 160 V, 250 V and 400 V versions and 500V + 50V for the 630V version.

R between terminations > 100.000 MΩ

R between interconnected terminations and case > 100.000 MΩ

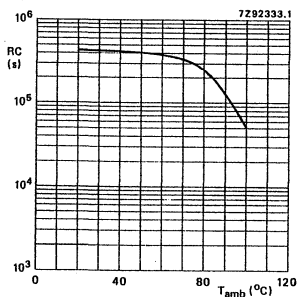

Fig.15 : RC-product as a function of ambient free air temperature ; typical curve.

Inductance

≤ 10 nH/cm lead and capacitor length

Polypropylene film/foil capacitors

2222 460/461/462/463/464

1.3.8 Maximum dissipation

The power dissipated by a capacitor is a function of the voltage U_{esr} across or the current I through the series resistance ESR and is expressed by:

$$P = \frac{U_{esr}^2}{ESR} \quad (1) \quad \text{or } P = ESR \cdot I^2 \quad (2)$$

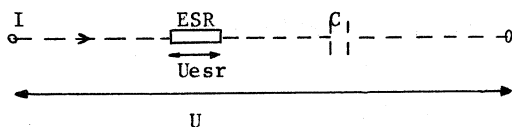

$$U_{esr}^2 = \frac{ESR^2}{ESR^2 + 1/w^2 C^2} \cdot U^2 \quad (3a)$$

As for film capacitors $\tan_{\Delta} = w \cdot C \cdot ESR \ll 0,1$, the formula (3a) can be simplified to

$$U_{esr}^2 = ESR^2 \cdot w^2 \cdot C^2 \cdot U^2 \quad (3b)$$

or with $ESR = \tan_{\Delta} / wC$, we become:

$$P = w \cdot C \cdot \tan_{\Delta} \cdot U^2 \quad (4) \quad \text{or } P = \frac{\tan_{\Delta}}{w \cdot C} I^2 \quad (5)$$

For the \tan_{Δ} we can take the value found from fig.14, C is in farad and $w = 2\pi \cdot f$.

U or I are assumed to be known.

The maximum permissible power dissipation (P_{max}), which depends on the dimensions of the capacitor and on the ambient free air temperature can be found from fig.16.

In applications where sine waves occur, we have to take for U the RMS-voltage or for I the RMS-current of the sine wave.

In applications where periodic signals occur, the signal has to be expressed in Fourier-terms:

$$U = U_0 + \sum_{k=1}^{\infty} \frac{1}{k+1} \sin(kwt + \psi_k) \quad (6)$$

Polypropylene film/foil capacitors

2222 460/461/462/463/464

$$I = \sum_{k=1}^{\infty} I_k \sin(k\omega t + \phi_k) \quad (7)$$

with U_0 the D.C.voltage, U_k and I_k the voltage resp. of the k -th harmonic.

We become for the dissipated power :

$$\text{with (6)} \quad P = \sum_{k=1}^{\infty} k \cdot \omega \cdot C \cdot \tan_{\text{delta}_k} \frac{U_k^2}{2} \quad (8)$$

$$\text{with (7)} \quad P = \sum_{k=1}^{\infty} \frac{\tan_{\text{delta}_k} \cdot I_k^2}{k \cdot \omega \cdot C \cdot 2} \quad (9)$$

and \tan_{delta_k} is the \tan_{delta} at the k -th harmonic.

Curve	Dimensions (mm)	
	d_max	l_max
1	5,0	11,0
2	5,5	15,0
3	6,0	15,0
4	6,5	15,0
5	7,0	15,0
6	7,5	15,0
7	8,0	15,0

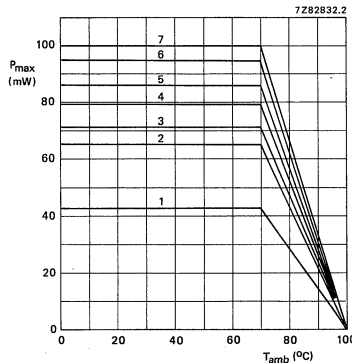

Fig.16 Maximum dissipation as a function of ambient free air temperature

* At $T_{\text{amb}} < 70^\circ\text{C}$ the maximum permissible sinusoidal voltage can be found in Figs. 9 to 13.

Polypropylene film/foil capacitors

2222 460/461/462/463/464

1.3.9 Application note

To select this capacitor for a certain application you have to check 5 conditions :

1. The peak voltage (U_p) shall not be greater than the rated d.c. voltage.
2. The peak to peak voltage (U_{pp}) shall not be greater than $2\sqrt{2}$ times the rated a.c. voltage to avoid the ionisation inception level.
3. There is no limit for the peak current (I_p) or voltage pulse slope (dU/dt) in the application.
4. The dissipated power shall not be greater than the maximum permissible power dissipation stated in 1.3.8.
5. The free air ambient temperature for the capacitor is not exceeding the category temperature.

Polypropylene film/foil capacitors**2222 460/461/462/463/464**

Example : $C = 0,039\mu\text{F}$ used for the following voltage signal

A sinewave signal with an a.c. voltage of 50V at 100kHz frequency.

The ambient temperature is 50°C .

Can a $0,039\mu\text{F}/160\text{Vdc}/63\text{Vac}$ be used for this application?

Checking the 6 conditions

1. The peak voltage $U_p = 70 (\sqrt{2} \times 50)$ is lower than 160Vdc.
2. The peak to peak voltage $141 U_{pp}$ is lower than 63Vac $2\sqrt{2} = 178 U_{pp}$
3. Pulse condition : of no consideration
4. The dissipated power is :

$$P = \omega \cdot C \cdot \tan_{\text{delta}} V^2 \quad (\tan_{\text{delta}} = 1,8 \cdot 10^{-4} \text{ from fig. 14})$$

$$= 2 \cdot \pi \cdot 100 \cdot 0,039 \cdot 10^{-6} \cdot 1,8 \cdot 10^{-4} \cdot (50)^2 = 11\text{mW}$$

This is less than 100mW at 50°C for its dimensions
8,0 x 15,0 , seen in fig. 16.

5. The free air ambient temperature is 50°C , and lower than 100°C .

Polypropylene film/foil capacitors

2222 460/461/462/463/464

1.4. Related documents

Generic specification	IEC 384-1
Sectional specification	IEC 384-13

1.5. Marking

The capacitors are marked in black ink with the following information :

- Capacitance n: nF p:pF
- Rated voltage (e.g. 63)
- Capacitance tolerance F : $\pm 1\%$ G : $\pm 2\%$ J : $\pm 5\%$
- Code for dielectrical material (KP)
- Production date code acc. to IEC 62, clause 5
- Manufacturer's name (PHILIPS)

Example : 9n1
G63
KP..
PHILIPS

Polypropylene film/foil capacitors

2222 460/461/462/463/464

The package containing the capacitors is marked as follows

Data on label SPQ and PQ
(example)

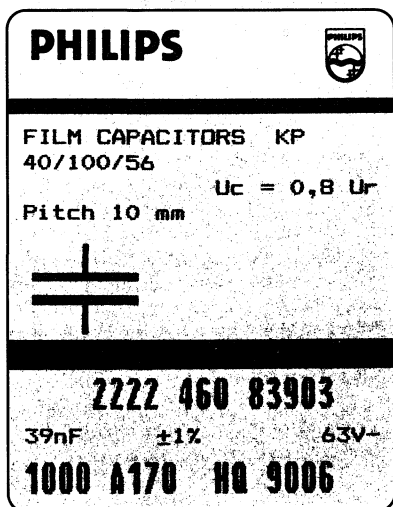

Block A : Philips word mark and emblem

Block B : Line 1 : Film capacitors and material code
Line 2 : Climatic group number and category voltage

Capacitor symbol

Block C : Line 1 : Product code (12NC)

Line 2 : Capacitance value
<10nF in pF followed by pF
> 10nf in µF followed by µF
Tolerance followed by + and %
Voltage followed by V-

Line 3 : Number of capacitors
Preference-origin code : A
Country of origin : Belgium=170
Responsible production centre : Philips Roeselare = HQ
Production period : year- and week code (4 digits)

1.6. Ordering information

Order the capacitors by quoting the 12-digit catalogue number as shown in Tables 1 to 5

Composition of the catalogue number

2222

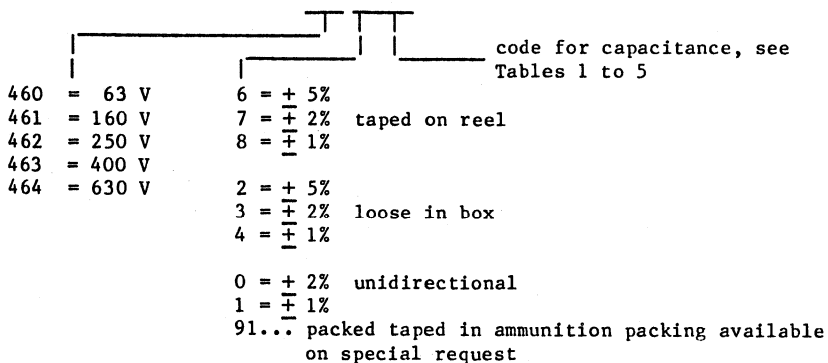

1.7. Certified test records (CTR)

Not required.

Polypropylene film/foil capacitors

2222 460/461/462/463/464

2. INSPECTION REQUIREMENTS

Note 1 : Sub-clause numbers of tests and performance requirements refer to the Sectional Specification, IEC-publication 384-13 and Section One of this specification.

Note 2 : Inspection levels and AQL's are selected from IEC-Publication 410 : Sampling Plans and Procedures for Inspection by attributes.

Note 3 : In this table :
p = periodicity (in months)
n = sample size
c = acceptance criterion (permitted number of defectives)
D = destructive
ND = non-destructive
IL = inspection level) IEC 410
AQL = acceptable quality level)

Note 4 : For this capacitor, considered as a solid construction, it is permitted to reduce the periodicity of the vibration and shock test from 6 months to 36 months.
In the event of a single defective occurring in subgroup Clb at this reduced rate of testing, then the vibration and shock tests shall revert to a 6 monthly periodicity until three successive 6-monthly tests shall have produced no defectives.

Polypropylene film/foil capacitors

2222 460/461/462/463/464

Clause number and Test (see Note 1)	D or ND	Conditions of Test (see Note 1)	IL (see Note 2)	AQL	Performance requirements (see note 1)
<u>Group A Inspection (lot-by-lot)</u>					
<u>Sub-group A1</u>					
4.1 Visual examination	ND		I	2,5%	- No mechanical failures - Legible marking and as specified in GENERAL DATA of this specification.
4.2 Dimensions		Gauging			- As specified in Tables 1 to 5 of this specification.
<u>Sub-group A2</u>					
4.2.1 Voltage proof (Test A)	ND	at $2 \times U_{Rdc}$ for 1 s.	I	1%	- No breakdown or flashover
4.2.2 Capacitance		at 1 kHz			- Within specified tolerance
4.2.3 Tangent of loss angle		$C < 1000\text{pF}$ at 1 MHz $C > 1000\text{pF}$ at 100kHz			- As in GENERAL DATA of this specification.

Polypropylene film/foil capacitors

2222 460/461/462/463/464

Sub-clause number and Test (see Note 1)	D or ND	Conditions of test (see Note 1)	Sample size + criterion of accepta- bility (see Note 3)			Performance requirements
			p	n	c	
<u>Group C inspection (periodic)</u>						
<u>Sub-group CIA</u> Part of sample of Sub-group C1	D		6	9	1	
4.1 Dimensions (detail)						As specified in GENERAL DATA
4.3.1 Initial measurements		Capacitance for C < 1000pF at 100 kHz C > 1000pF at 1 kHz Tangent of loss angle for C < 1000pF at 1 MHz C > 1000pF at 100 kHz				
4.3 Robustness of terminations		Tensile Bending Torsion				No visible damage
4.4 Resistance to soldering heat		No pre-drying Methode : 1A Solder bath : 260°C Duration : 5 s				
4.14 Component solvent resistance		Mixture 1,1,2- trichlorotrifluoro- ethane and 2 - propanol (isopro- pylalcohol) boiling temperature 48,6 to 50,5°C Method : 2 Immersion time : 5 + 0,5 min. Recovery time : min. 1h max. 2h				
4.4.2 Final measurements		Visual examination Capacitance				No visible damage Legible marking $\frac{\Delta C}{C} < 2\% + 1pF$ for C < 1100pF < 1% for C > 1100pF of the value measured in 4.3.1

Polypropylene film/foil capacitors

2222 460/461/462/463/464

Sub-clause number and Test (see Note 1)	D or ND	Conditions of test (see Note 1)	Sample size + criterion of accepta- bility (see Note 3)			Performance requirements
			p	n	c	
Sub-group C1B Other part of sample of Sub-group C1	D		6	18	1	
4.6.1 Initial measurements		Capacitance for C < 1000pF at 100 kHz C > 1000 pF at 1 kHz Tangent of loss angle for C < 1000pF at 1 MHz C > 1000pF at 100 kHz				
4.6 Rapid change of of temperature		ΘA=lower cat. temp. ΘB=upper cat. temp. Five cycles Duration t = 30min. Visual examination				No visible damage
4.7 Vibration (see Note 4)		Method of mounting see GENERAL DATA of this specification. Procedure B4. Frequency range : 10Hz to 55Hz. Pulse shape : half sine Amplitude 0,75mm or acceleration 98m/s ² (whichever is the less severe) Total duration 6h				
4.7.2 Final inspection		Visual examination				No visible damage
Intermediate measurement		Capacitance				$\frac{\Delta C}{C} \leq 2\% + 1pF$ for C < 1100pF $\leq 1\%$ for C > 1100pF of the value measured in 4.6.1
		Tangent of loss angle				As in GENERAL DATA of this specification

Polypropylene film/foil capacitors

2222 460/461/462/463/464

Sub-clause number and Test (see Note 1)	D or ND	Conditions of test (see Note 1)	Sample size + criterion of acceptability (see Note 3)			Performance requirements
			p	n	c	
4.9 Shock (see Note 4)		Method of mounting see GENERAL DATA of this specification Pulse shape : half sine Accelerat.: 490m/s^2 Duration of pulse : 11ms				
4.9.3 Final measurements		Visual examination Capacitance				No visible damage $\frac{\Delta C}{C} \leq 2\% + 1\text{pF}$ for $C < 1100\text{pF}$ $< 1\%$ for $C > 1100\text{pF}$ of the value measured in 4.6.1
<u>Sub-group C1</u> Combined sample of specimens of Sub- groups C1A and C1B	D		6	27	2	
4.10 Climatic sequence						
4.10.2 Dry heat		Temperature : upper category temperature Duration : 16h				
4.10.3 Damp heat cyclic, Test Db, first cycle						
4.10.4 Cold		Temperature : lower category temperature Duration : 2h				
4.10.6 Damp heat cyclic, Test Db remaining cycle		Recovery 1 to 2 h.				

Polypropylene film/foil capacitors

2222 460/461/462/463/464

Sub-clause number and Test (see Note 1)	D or ND	Conditions of test (see Note 1)	Sample size + criterion of accepta- bility (see Note 3)			Performance requirements
			p	n	c	
4.10.6.2 Final measurements		Visual examination Capacitance Tangent of loss angle Insulation resis- tance				No visible damage Legible marking $\frac{\Delta C}{C} < 1\% + 1\text{pF}$ for $C < 1100\text{pF}$ $< 1\%$ for $C > 1100\text{pF}$ of the value measured in 4.10.2 As in GENERAL DATA of this specification or $< 1,4$ value measured in 4.3.1 or in 4.6.1 whichever is greater >50% of values in GENERAL DATA of this specification
<u>Sub-group C2</u> 4.11 Damp heat steady state 4.11.1 Initial measurements 4.11.3 Final measurements	D	Capacitance for $C < 1000\text{pF}$ at 100 kHz $C > 1000\text{pF}$ at 1 kHz Tangent of loss angle for $C < 1000\text{pF}$ at 1 MHz $C > 1000\text{pF}$ at 100kHz Recovery 1 to 2 h. Visual examination Capacitance Tangent of loss angle Insulation resistance	6	15	1	No visible damage Legible marking $\frac{\Delta C}{C} < 1\% + 1\text{pF}$ for $C < 1100\text{pF}$ $< 1\%$ for $C > 1100\text{pF}$ compared to values measured in 4.11.1 As in GENERAL DATA of this specification or $< 1,4$ value measured in 4.11.1 whichever is greater >50% of values in GENERAL DATA of this specification

Polypropylene film/foil capacitors

2222 460/461/462/463/464

Sub-clause number and Test (see Note 1)	D or ND	Conditions of test (see Note 1)	Sample size + criterion of accepta- bility (see Note 3)			Performance requirements
			p	n	c	
<u>Sub-group C3</u>	D		3	21	1	
4.12 Endurance		Duration : 1000 h. 1,5 U_{Rdc} at 85°C 1,5 U_C at 100°C				
4.12.1 Initial measurements		Capacitance for C < 1000pF at 100 kHz C > 1000pF at 1 kHz Tangent of loss angle for C < 1000pF at 1 MHz C > 1000pF at 100kHz				
4.12.5 Final measurements		Visual examination Capacitance Tangent of loss angle Insulation resistance				No visible damage Legible marking $\frac{\Delta C}{C} < 2\% + 1pF$ for C < 1100pF < 1% for C > 1100pF compared to values measured in 4.12.1 As in GENERAL DATA of this specification or < 1,4 value measured in 4.12.1 whichever is greater As in GENERAL DATA of this specifi- cation.

Polypropylene film/foil capacitors

2222 460/461/462/463/464

Sub-clause number and Test (see Note 1)	D or ND	Conditions of test (see Note 1)	Sample size + criterion of accepta- bility (see Note 3)			Performance requirements
			p	n	c	
<u>Sub-group C4</u>	D		12	9	1	
4.2.5 Variation of capacitance with temperature		Static method The capacitors shall be dried Number of cycles :1				Temp. coeff. as in GENERAL DATA of this specification
		Capacitance measurements for C < 1000pF at 100kHz C > 1000pF at 1 kHz				Temperature cyclic drift of capaci- tance $\frac{\Delta C}{C} < 2\% + 1pF$ for C < 1100pF $< 1\%$ for C > 1100 pF compared to values measured in 4.4.2 or 4.9.3
4.2.6 Inductance		Insulation resistance				> 10.000 MΩ
						As in GENERAL DATA of this specifi- cation

Polypropylene film/foil capacitors

2222 460/461/462/463/464

Additional tests	D or ND	Conditions of test	Sample size + criterion of accepta- bility			Performance requirements
			p	n	c	
<hr/>						
<u>Sub-group ADD1</u> A.1 Solderability	D	Without ageing Method : 1 Non-activated colo- phany flux 501 Solder bath 235°C Dwell time : 2 s.	3	35	1	Good tinning as evidenced by free flowing of the solder with wet- ting of the ter- minations (>95%)
Solvent resistance		Mixture 1,1,2- tri- chlorotrifluoroeth- ane and 2-propanol (isopropylalcohol) Boiling temperature 48,6°C to 50,5°C Method 1 Rubbing material : cotton wool Immersion time : 5 ± 0,5 min.				
<hr/>						
<u>Sub-group ADD2</u> A.2 Heat storage	D	Duration : 1000h Temperature : upper category temperature	3	21	1	
A.2.1 Initial measurements		Capacitance for C < 1000pF at 100 kHz C > 1000pF at 1 kHz Tangent of loss angle for C < 1000pF at 1 MHz C > 1000pF at 100 kHz				
A.2.2 Final measurements		Capacitance Tangent of loss angle Insulation resistance				$\frac{\Delta C}{C} \leq 2\% + 1pF$ for C < 1100pF < 1% for C > 1100 pF compared to values measured in A.2.1 As in GENERAL DATA of this specifi- cation or < 1,4 value measured in A.2.1 whichever is greater. As in GENERAL DATA of this specifi- cation.

Polypropylene film/foil capacitors

2222 460/461/462/463/464

Additional tests	D or ND	Conditions of test	Sample size + criterion of accepta- bility			Performance requirements
			p	n	c	
<hr/>						
<u>Sub-group ADD3</u>			3	9	1	
A.3 Detergent resistance		Density 20g/l Dishwater detergent Temperature 70°C during 3 min. Followed by rinsing in clear water for 1 min. Recovery time > 2h				
A.3.1 Initial measurements		Capacitance for C < 1000pF at 100kHz C > 1000pF at 1 kHz Tangent of loss angle for C < 1000pF at 1 MHz C > 100pF at 100 kHz				
A.3.2 Final measurements		Capacitance for Tangent of loss angle Insulation resistance				$\frac{\Delta C}{C} \leq 1\% + 0,5pF$ for C < 1100pF < 1% for C > 1100 pF compared to values measured in A.3.1 As in GENERAL DATA of this specifi- cation or $\leq 1,4$ value measured in A.3.1 whichever is greater. > 50% of valuesA in GENERAL DATA of this specifica- tion.

Polypropylene film/foil capacitors

2222 460/461/462/463/464

Additional tests	D or ND	Conditions of test	Sample size + criterion of accepta- bility			Performance requirements
			p	n	c	
<u>Sub-group ADD 4</u>	D		6	15	1	
A.4 Resistance to soldering heat with pre-heating.		Capacitors mounted on a 1,6mm board with nonplated holes Body temp. : 80°C Bath temp. : 260°C Dwell time : 5s				
A.4.1 Initial measurements		Capacitance for C < 1000pF at 100kHz C > 1000pF at 1 kHz				
A.4.2 Final measurements		Capacitance				$\frac{\Delta C}{C} \leq 2\% + 1\text{pF}$ for C < 1100pF < 1% for C > 1100 pF compared to values measured in A.4.1

Polypropylene film/foil capacitors

2222 460/461/462/463/464

Additional tests	D or ND	Conditions of test	Sample size + criterion of accepta- bility			Performance requirements
			p	n	c	
<hr/>						
<u>Sub-group ADD5</u>						
A.5 Climatic test on taped type		10 days at 40 +2°C R.H. 90 to 95% Recovery time : 24h	3	5	0	Deviation of tape on a strip of 250mm taped pro- ducts < 2%. Pull out and tearing force > 50% of values In GENERAL DATA of this specifi- cation.
<hr/>						
<u>Sub-group ADD6</u>						
A.6 Passive flammabili- ty IEC 40 (secr.) 580 Class C		Bore of gas jet : ∅ 0,5 mm Fuel : butane One application Test duration is function of actual volume of capacitor	6	15	1	After removing the test flame from the capacitor must not continue to burn for more than 10s, no burning particles must drop from the sample.
<hr/>						

Polypropylene film/foil capacitors

2222 460/461/462/463/464

Additional tests	D or ND	Conditions of test	Sample size + criterion of accepta- bility			Performance requirements
			p	n	c	
<hr/>						
<u>Sub-group ADD6</u>			3	5	0	
A.6 Climatic test on taped type		10 days at 40 +2°C R.H. 90 to 95% Recovery time : 24h				Deviation of tape on a strip of 250mm taped pro- ducts < 2%. Pull out and tearing force > 50% of values In GENERAL DATA of this specifi- cation.
<hr/>						
<u>Sub-group ADD7</u>			6	15	1	
A.7 Passive flammabili- ty IEC 40 (secr.) 580 Class C		Bore of gas jet : ∅ 0,5 mm Fuel : butane One application Test duration is function of actual volume of capacitor				After removing the test flame from the capacitor must not continue to burn for more than 10s, no burning particles must drop from the sample.
<hr/>						

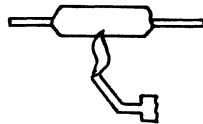

Specials

Philips Components

Data sheet	
status	Product specification
date of issue	May 1990

2222 311 90015/90016

Interference suppression capacitors

KT* Radial phenolic lacquered types

- ° 11,5mm terminal pitch
- ° Supplied loose in box and taped on reel

QUICK REFERENCE DATA

Rated capacitance value	5600pF
Capacitance range	5000-7000pF
Rated voltage U _{Rac}	250V
Climatic category	40/085/21
Tangent of loss angle at 1kHz	60×10^{-4}
Related specification	IEC 384-14

* KT = polyethyleneterephthalate

Interference suppression capacitors

2222 311 90015/2222 311 90016

SURVEY OF STYLES

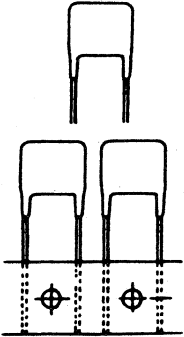

2222 311 90015

Pitch : 11,5mm

2222 311 90016

Pitch : 11,5mm

CONSTRUCTION

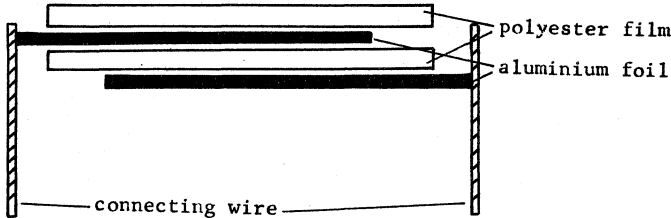

Interference suppression capacitors

2222 311 90015/2222 311 90016

APPLICATION

The capacitors are suitable for radio-interference suppression and incorporated in starters for fluorescent lamp circuits.

DESCRIPTION

The capacitors consist of an impregnated, non-inductive wound cell of aluminium foil with a polyethyleneterephthalate (PETP)-film. The cell is protected by an insulating lacquer.
The radial leads are of solder-coated wire.

1. GENERAL DATA

1.1. Mounting

Normal use

The capacitors are designed for point-to-point wiring.

Specific method of mounting for vibration and bump

Not applicable

Interference suppression capacitors

2222 311 90015/2222 311 90016

1.2.1 Dimensions in mm

2222 311 90015 normal version.

2222 311 90016 taped version.

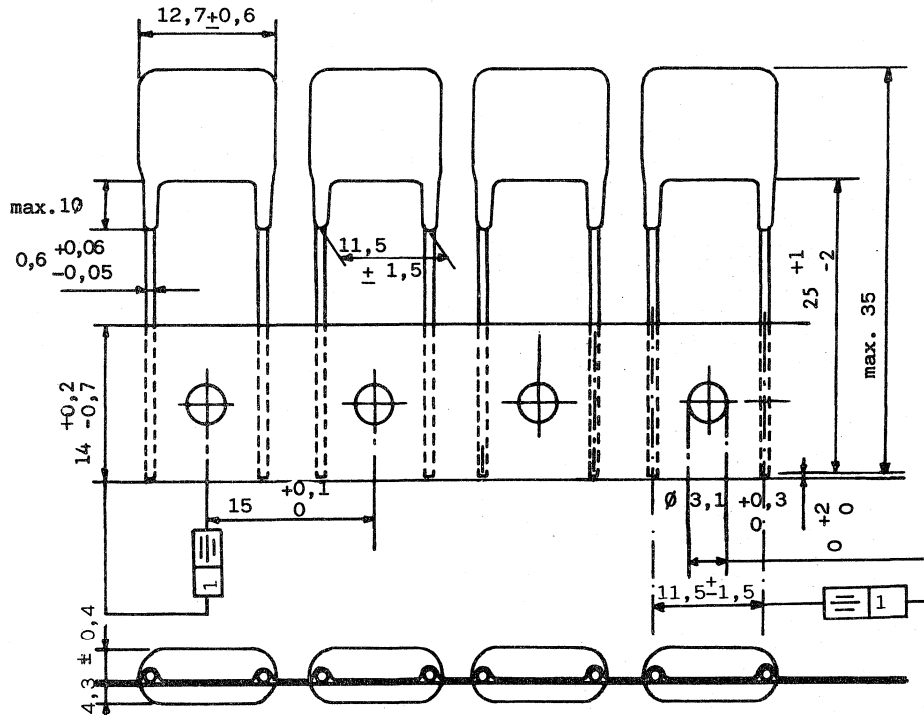

Note : Restrictions on max. tolerance combinations of length and thickness.

A limit is imposed by the following additional requirements : capacitors must fit a jig, consisting of a cylinder with an inside diameter of $19,3 - 0,1\text{mm}$, containing a cylinder, with an outside diameter of $12,6 + 0,1\text{mm}$, which is fixed against the wall of the outer cylinder.

The max. number of empty places per reel shall not exceed 0,25% of the total number of components per reel, but no more than 2 consecutive positions may be vacant.

Interference suppression capacitors

2222 311 90015/2222 311 90016

1.2.2 Packing

°Style 2222 311 90015

The capacitors are supplied loose in boxes; the number per box is 4000 (SPQ) and 16000 (PQ).

°Style 2222 311 90016

The capacitors are supplied taped on reel; the number per reel is 3000 (SPQ) and 15000 (PQ).

Characteristics of taped products

Pull-out force of the component $\geq 0,5N$ and $< 3N$

Pull-off force of adhesive tape $\geq 1 N$

Tearing force of tape $\geq 15 N$

Storage conditions :

Storage temperature
Relative humidity

$-25^{\circ}C$ to $+ 40^{\circ}C$
max. 80% without condensation

Interference suppression capacitors

2222 311 90015/2222 311 90016

1.3. Ratings and characteristics

Unless otherwise specified all electrical values apply to an ambient free air temperature of $23 \pm 1^\circ\text{C}$, an atmospheric pressure of 86 to 106 kPa and a relative humidity of $50 \pm 2\%$.

1.3.1 Capacitance

Capacitance value at 1 kHz	5600pF
Capacitance range	5000-7000pF

1.3.2 Voltage

Rated voltage U_{Rac}	250V
Test voltage (d.c.) between terminations (test A)*	3000V

1.3.3 Climatic category

40/085/21

1.3.4 Storage temperature range

Temperature -25°C to $+40^\circ\text{C}$
RH max. 80% without condensation

1.3.5 Tangent of loss angle at 1kHz $\leq 60 \times 10^{-4}$

Graph : $\text{Tan}_{\text{delta}}$ as a function of frequency; typical curve.

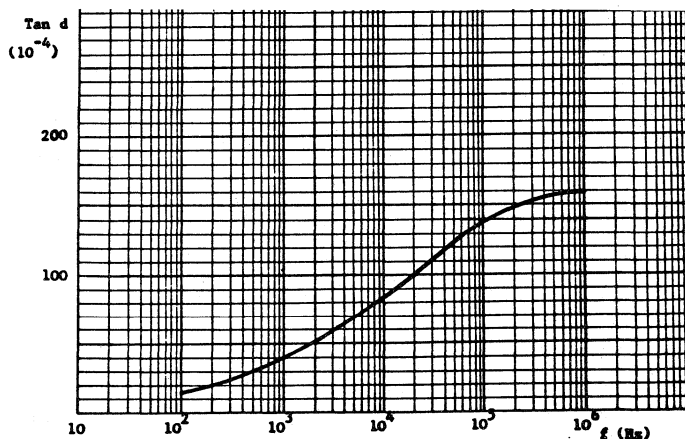

* IEC-384-1

Interference suppression capacitors

2222 311 90015/2222 311 90016

1.3.6 Insulation resistance at T_{amb} 20°C.

The insulation resistance is measured after a voltage of 100 \pm 15V
has been applied for 1 min. \pm 5s.

R between terminations \geq 50 000 M Ω

1.4. Related documents

Generic specification IEC 384-1

Sectional specification IEC 384-14

1.5. Marking

The capacitors have no marking

Interference suppression capacitors

2222 311 90015/2222 311 90016

The package containing the capacitors is marked as follows

Data on label SPQ and PQ
(example)

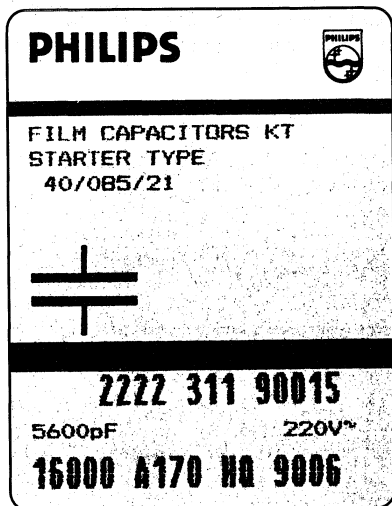

Block A : Philips word mark and emblem

Block B : Line 1 : Film capacitors and material code
Line 2 : Starter type

Line 3 : Climatic category
Capacitor symbol

Block C : Line 1 : Product code (12 NC)

Line 2 : Capacitance value
in pF followed by pF
Voltage followed by V~

Line 3 : Number of capacitors
Preference-origin code : A
Country of origin : Belgium=170
Responsible production centre :
Philips Roeselare = HQ
Production period : year- and week code (4 digits)

1.6. Ordering information

Order the capacitors by quoting the 12-digit catalogue number.

1.7. Certified test records (CTR)

Not required.

Interference suppression capacitors

2222 311 90015/2222 311 90016

2. INSPECTION REQUIREMENTS

Note 1 : Sub-clause numbers of tests and performance requirements refer to the Sectional Specification, IEC-publication 384-14 and Section One of this specification. Taking into account the special application conditions, different deviations from test schedule and requirements are introduced.

Note 2 : Inspection levels and AQL's are selected from IEC-Publication 410 : Sampling Plans and Procedures for Inspection by attributes.

Note 3 : In this table :

- p = periodicity (in months)
- n = sample size
- c = acceptance criterion (permitted number of defectives)
- D = destructive
- ND = non-destructive
- IL = inspection level) IEC 410
- AQL = acceptable quality level)

Interference suppression capacitors

2222 311 90015/2222 311 90016

Clause number and Test (See Note 1)	D or ND	Conditions of Test (See Note 1)	IL (See note 2)	AQL	Performance requirements (See note 1)
<u>Group A Inspection (lot-by-lot)</u>					
<u>Sub-group A1</u>					
4.1 Visual examination	ND		I	2,5%	- No mechanical failures
4.2 Dimensions		Gauging			- As specified in GENERAL DATA of this specifi- cation
<u>Sub-group A2</u>					
4.2.2 Capacitance	ND	at 1kHz	I	1%	- Within specified limits
4.2.3 Tangent of loss angle		at 1kHz			- As in GENERAL DATA of this specification
4.2.1 Voltage proof (Test A)		3000V(d.c.) for 1 s.			- No breakdown or flashover

Interference suppression capacitors

2222 311 90015/2222 311 90016

Sub-clause number and Test (see note 1)	D or ND	Conditions of test (see note 1)	Sample size + criterion of accepta- bility (see note 3)			Performance requirements
			p	n	c	
Group C inspection (periodic)						
<u>Sub-group ClA</u>	D		6	9	1	
Part of sample of Sub-group Cl						
4.1 Dimensions (detail)						As specified in GENERAL DATA
4.3.1 Initial measurements		Capacitance				
4.3 Robustness of terminations		Tensile strength : 5N Bending : not applicable				
4.4.2 Final measurements		Visual examination				No visible damage Legible marking
<u>Sub-group ClB</u>	D		6	18	1	
Part of sample of Sub-group Cl						
4.6.1 Initial measurements		Capacitance				
4.6 Rapid change of temperature		⊖ A=lower category temperature ⊖ B=upper category temperature 5 cycles Duration t = 30min.				
4.8.3 Final measurements		Visual examination				No visible damage
		Capacitance				$\Delta \frac{C}{C} \leq 10\%$ of the value measured in 4.6.1

Interference suppression capacitors

2222 311 90015/2222 311 90016

Sub-clause number and Test (see note 1)	D or ND	Conditions of test (see note 1)	Sample size + criterion of accepta- bility (see note 3)			Performance requirements
			p	n	c	
<u>Sub-group C1</u>	D		6	27	2	
Combined sample of spe- cimens of Sub-groups C1A and C1B						
4.10 Climatic sequence						
4.10.2 Dry heat		Temperature : upper category temperature Duration : 16h				
4.10.3 Damp heat cyclic, Test Db, first cycle						
4.10.4 Cold		Temperature : lower category temper. Duration : 2h				
4.10.6 Damp heat cyclic, Test Db remaining cycles		Test voltage 710V (d.c.) for 1 min.				
4.10.6.2 Final measurements		Visual examination Capacitance Tangent of loss angle Insulation resistance				No visible damage Legible marking $\Delta \frac{C}{C} \leq 10\%$ of value measured in 4.3.1. or 4.8.3. As in GENERAL DATA of this specifi- cation. > 50% of value in GENERAL DATA of this specification
<u>Sub-group C2</u>	D		6	15	1	
4.11 Damp heat, steady state						
4.11.1 Initial measurements		Capacitance				
4.11.3 Final measurements		After test, test voltage 710V (d.c.) for 1 min. Visual examination Capacitance Tangent of loss angle Insulation resistance				No visible damage $\Delta C/C < 5\%$ As in GENERAL DATA of this specifi- cation. > 50% of value in GENERAL DATA of this specification

Interference suppression capacitors

2222 311 90015/2222 311 90016

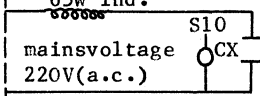
Additional tests	D or ND	Conditions of test (see note 1)	Sample size + criterion of accepta- bility			Performance requirements
			p	n	c	
<hr/>						
<u>Sub-group ADD1</u>	D		3	21	1	
A.1 Endurance		Duration : 2000h Temperature : 8h at 25°C and 16h at upper temperat. Voltage : 200Vac, 50Hz				
A.1.1 Initial measurements		Capacitance Tangent of loss angle at 1kHz				
A.1.2 Final		Capacitance Tangent of loss angle Insulation resistance				$\Delta C/C \leq 10\%$ of value measured in in A.1.1 As in GENERAL DATA of this specifi- cation. $\geq 50\%$ of values in GENERAL DATA of this specification
<u>Sub-group ADD2</u>	D		3	30	1	No damage No short circuit
A.2 Intermittent voltage-test (continuous operation)		<p>65W ind.</p>  <p>mainsvoltage 220V(a.c.)</p> <p>Capacitors to be operated 8h at room temperature</p>				

Interference suppression capacitors

2222 311 90015/2222 311 90016

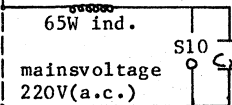
Additional tests	D or ND	Conditions of test (see note 1)	Sample size + criterion of acceptability			Performance requirements
			p	n	c	
<hr/>						
<u>Sub-group ADD3</u>	D	 <p>65W ind. mainsvoltage 220V(a.c.)</p> <p>S10 Cx</p> <p>Capacitors to be operated 4h at room temperature and 4h at upper temp. (two times)</p>	3	30	1	No damage No short circuit
A.3 Intermittent voltage-test (continuous operation)						
Note : Short circuited products must withstand the short circuit current during min. 15 min. without signs of burning.						
<hr/>						
<u>SUB-GROUP ADD4</u>	D	<p>The capacitors under test are short-circuited by an increasing a.c. voltage. The voltage source is appr. 1kVA. Capacitors in series with an inductor of 65W, with U_{Rac}, 50Hz applied for 5 min..</p>	6	5	0	No visible combustion marks.
A.4 Active flammability						
<u>Sub-group ADD5</u>	D	<p>10 days at 40 + 2°C R.H. 90 to 95% Recovery time 24h</p>	3	5	0	Change in position of lead hole over 10 pitch distance ≤ 0,5mm. Full-out force of the component ≥ 0,5N and < 3N.
A.5 Climatic test on taped products						

Philips Components

Data sheet	
status	
code	
date of issue	

2222 311 90026/90027

Interference suppression capacitors

KT* Radial potted types

- ° 10mm terminal pitch
- ° Supplied loose in box

QUICK REFERENCE DATA

	2222 311	
	90026	90027
Capacitance value	3000pF	1200pF
Capacitance tolerance	+ 20%	- 20/+ 30%
Rated voltage U _{Rac}	250V	
Climatic category	40/125/56	
Upper temperature	125°C	140°C
Tangent of loss angle at 1kHz	60×10^{-4}	
Reference specification	IEC 384-14	

* KT = polyethylenetherephthalate

Interference suppression capacitors

2222 311 90026/90027

SURVEY OF STYLES

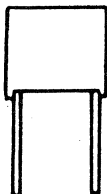

2222 311 90026
90027
Terminal pitch : 10mm

CONSTRUCTION

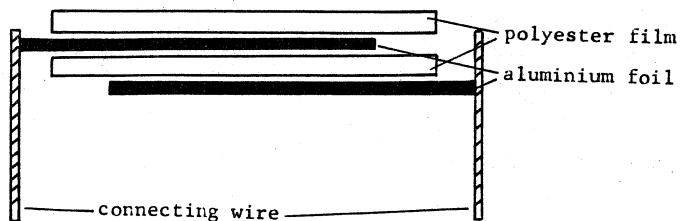

Interference suppression capacitors

2222 311 90026/90027

APPLICATION

The capacitors are suitable for radio-interference suppression and incorporated in starters for fluorescent lamp circuits.

DESCRIPTION

The capacitors consist of an impregnated, non-inductive wound cell of aluminium foil with a polyethyleneterephthalate (PETP)-film. The cell is potted with epoxy resin in a *flame retardant polypropylene case.

The radial leads are of solder-coated wire.

*2222 311 90026 blue
90027 yellow

1. GENERAL DATA

1.1. Mounting

Normal use

The capacitors are designed for point-to-point wiring.

Specific method of mounting for vibration and bump

Not applicable

Interference suppression capacitors

2222 311 90026/90027

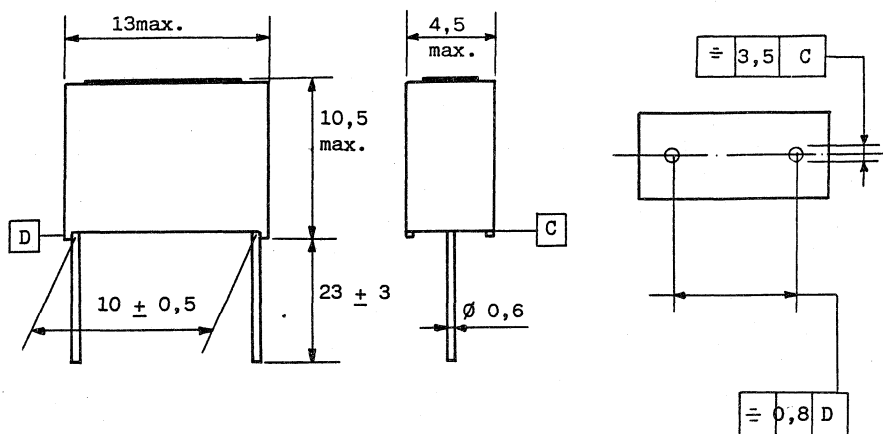
1.2.1 Dimensions in mm1.2.2 Packing

The capacitors are supplied loose in box, the quantity per box is 2000 (SPQ) and 8000 (PQ).

Interference suppression capacitors

2222 311 90026/90027

1.3. Ratings and characteristics

Unless otherwise specified all electrical values apply to an ambient free air temperature of $23 \pm 1^\circ\text{C}$, an atmospheric pressure of 86 to 106kPa and a relative humidity of $50 \pm 2\%$.

1.3.1 Capacitance

2222 311

	90026	90027
Capacitance values at 1 kHz	3000pF	1200pF
Capacitance tolerance	$\pm 20\%$	$- 20/+ 30\%$

1.3.2 Voltage

Rated voltage U_{Rac}

250V

Test voltage (d.c.)
between terminations

2000V | 2500V

1.3.3 Climatic category

40/125/56

1.3.4 Upper temperature range

125°C | 140°C

1.3.5 Storage temperature range

Temperature -25°C to $+40^\circ\text{C}$
RH max. 80% without condensation

1.3.6 Tangent of loss angle

at 1 kHz : $\leq 60 \times 10^{-4}$

Graph : Tan_Δ as a function of frequency; typical curve.

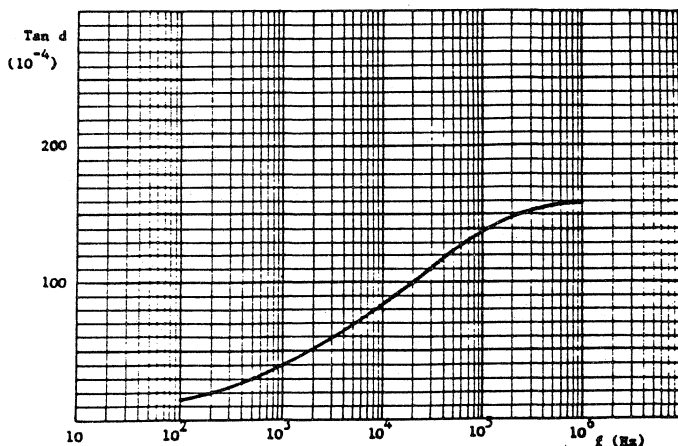

Interference suppression capacitors

2222 311 90026/90027

1.3.7 Insulation resistance at $T_{amb} 20^{\circ}C$ -----

The insulation resistance is measured after a voltage of 100 $\pm 15V$ has been applied for 1 min. $\pm 5s$.

R between terminations $\geq 50\ 000\ M\Omega$

1.4. Related documents

Generic specification IEC 384-1

Sectional specification IEC 384-14

1.5. Marking

- ° Style 2222 311 90026

The capacitors are marked on the top by embossed print with S 18

- ° Style 2222 311 90027

The capacitors are marked on the top by embossed print with S 25

Interference suppression capacitors

2222 311 90026/90027

The package containing the capacitors is marked as follows
 Data on label SPQ and PQ
 (example)

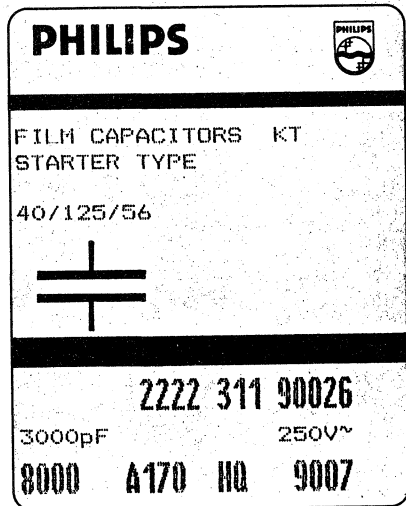

Block A : Philips word mark and emblem

Block B : Line 1 : Film capacitors and material code

Line 2 : Starter type

Line 3 : Climatic category

Capacitor symbol

Block C : Line 1 : Product code (12 NC)

Line 2 : Capacitance value

in pF followed by pF

Voltage followed by V_r

Line 3 : Number of capacitors

Preference-origin code : A

Country of origin : Belgium=170

Responsible production centre :

Philips Roeselare = HQ

Production period : year- and

week code (4 digits)

1.6. Ordering information

Order the capacitors by quoting the 12-digit catalogue number

1.7. Certified test records (CTR)

Not required.

Interference suppression capacitors

2222 311 90026/90027

2. INSPECTION REQUIREMENTS

Note 1 : Sub-clause numbers of tests and performance requirements refer to the Sectional Specification, IEC-publication 384-14 and Section One of this specification. Taking into account the special application conditions, different deviations from test schedule and requirements are introduced.

Note 2 : Inspection levels and AQL's are selected from IEC-Publication 410 : Sampling Plans and Procedures for Inspection by attributes.

Note 3 : In this table :

- p = periodicity (in months)
- n = sample size
- c = acceptance criterion (permitted number of defectives)
- D = destructive
- ND = non-destructive
- IL = inspection level) IEC 410
- AQL = acceptable quality level)

Interference suppression capacitors

2222 311 90026/90027

Clause number and Test (See Note 1)	D or ND	Conditions of Test (See Note 1)	IL (See note 2)	AQL	Performance requirements (See note 1)
<u>Group A Inspection (lot-by-lot)</u>					
<u>Sub-group A1</u>	ND		I	2,5%	
4.1 Visual examination					- No mechanical failures - Legible marking and as specified in GENERAL DATA of this specifi- cation.
4.2 Dimensions		Gauging			- As specified in GENERAL DATA of this specifi- cation.
<u>Sub-group A2</u>	ND		I	1%	
4.2.2 Capacitance		at 1kHz			- Within specified tolerance
4.2.3 Tangent of loss angle		at 1kHz			- As in GENERAL DATA of this specification
4.2.1 Voltage proof (Test A)		at 2250V(d.c.) for 2222 311 90026 at 2750V(d.c.) for 2222 311 90027 for 1 s.			- No breakdown or flashover

Interference suppression capacitors

2222 311 90026/90027

Sub-clause number and Test (see note 1)	D or ND	Conditions of test (see note 1)	Sample size + criterion of accepta- bility (see note 3)			Performance requirements
			p	n	c	
<u>Group C inspection (periodic)</u>						
<u>Sub-group CIA</u>	D		6	9	1	
Part of sample of Sub-group C1						
4.1 Dimensions (detail)						As specified in GENERAL DATA of this specification
4.3.1 Initial measurements		Capacitance				
4.3 Robustness of terminations		Tensile strength : 10N Bending : 5N Torsion : two successive rota- tions of 30°				
4.4.2 Final measurements		Visual examination				No visible damage Legible marking
<u>Sub-group C1B</u>	D		6	18	1	
Part of sample of Sub-group C1						
4.6.1 Initial measurements		Capacitance				
4.6 Rapid change of temperature		θA=lower category temperature θB=upper category temperature Duration t = 30min.				5 cycles
4.8.3 Final measurements		Visual examination Capacitance				No visible damage $\Delta C \leq 10\%$ of the \bar{C} value measured in 4.6.1

Interference suppression capacitors

2222 311 90026/90027

Sub-clause number and Test (see note 1)	D or ND	Conditions of test (see note)	Sample size + criterion of accepta- bility (see note)			Performance requirements
			p	n	c	
<u>Sub-group C1</u> Combined sample of spe- cimens of Sub-groups C1A and C1B 4.10 Climatic sequence	D		6	27	2	
4.10.2 Dry heat		Temperature : upper category temperature Duration : 16h				
4.10.3 Damp heat cyclic, Test Db, first cycle						
4.10.4 Cold		Temperature : lower category temper. Duration : 2h				
4.10.6 Damp heat cyclic, Test Db remaining cycles		Test voltage 710V (d.c.) for 1 min.				
4.10.6.2 Final measurements		Visual examination Capacitance Tangent of loss angle Insulation resistance				No visible damage Legible marking $\frac{\Delta C}{C} < 10\%$ of value measured in 4.3.1 or 4.8.3 of this spec. As in GENERAL DATA of this specif. > 50% of values in GENERAL DATA of this specifi- cation.
<u>Sub-group C2</u> 4.11 Damp heat, steady state	D		6	15	1	
4.11.1 Initial measurements		Capacitance				
4.11.3 Final measurements		After test, test voltage 710V (d.c.) for 1 min. Visual examination Capacitance Tangent of loss angle Insulation resistance				No visible damage $\Delta C/C < 5\%$ As in GENERAL DATA of this specific. > 50% of value in GENERAL DATA of this specification

Interference suppression capacitors

2222 311 90026/90027

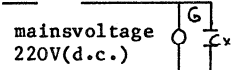
Additional tests	D or ND	Conditions of test	Sample size + criterion of accepta- bility			Performance requirements
			p	n	c	
<u>Sub-group ADD1</u>	D		3	42	1	
A.1 Endurance		Duration : 2000h Temperature : 8h at 25°C and 16h at upper temperat. Voltage : 1,25xmax. a.c. voltage, 50Hz				
A.1.1 Initial measurements		Capacitance Tangent of loss angle at 1kHz				
A.1.2 Final measurements		Capacitance Tangent of loss angle Insulation resistance				$\Delta C/C \leq 10\%$ of value measured in in A.1.1 As in GENERAL DATA of this specifi- cation. > 50% of values in GENERAL DATA of this specification
<u>Sub-group ADD2</u>	D		3	60	1	
A.2 Intermittent voltage-test		VSA  Capacitors to be operated 8h at room temperature and 16h at upper temperature (four times) with a switching cycle as in table. VSA lamp switching G cycle on/off				No damage No short circuit
		2222 311 90027 SL25 SL25 3s./27s. 2222 311 90026 SL18 SL18 3s./27s.				
		After the first 48h the glow switch must be replaced				

Note : Short circuited products must withstand the short circuit current during min. 15 min. without signs of burning.

Philips Components

Data sheet	
status	Product specification
date of issue	May 1990

2222 347**Polyethyleneterephthalate film/foil capacitors**

KT Radial phenolic lacquered type

- ° 10,16 to 27,94mm terminal pitch
- ° Supplied loose in box

QUICK REFERENCE DATA

Capacitance range (E12-series)	0,001 to 1 μ F
Capacitance tolerance	<u>+20%</u> , <u>+10%</u>
Rated voltage U _{Rdc}	100V, 250V, 400V, 630V
Climatic category	40/100/21
Rated temperature	85°C
Related specification	IEC 384-11

Polyethyleneterephthalate film/foil capacitors

2222 347

SURVEY OF STYLES

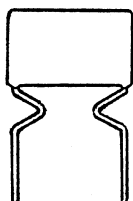

Style : 2222 347

Terminal pitch : 10,16 to 27,94 mm

See Tables 1 to 4

CONSTRUCTION

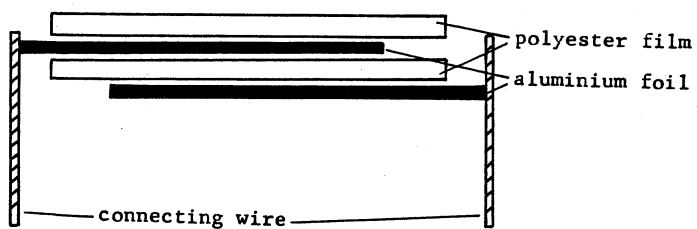

Polyethyleneterephthalate film/foil capacitors

2222 347**APPLICATION**

For use in wide range of consumer and industrial applications, especially where high currents and/or steep pulses occur. The capacitors are suited for d.c. or a.c. operation.

DESCRIPTION

The capacitors consist of a low-inductive wound cell of metal foil and a polyethyleneterephthalate film. The cell is protected by a hard, tan coloured lacquer, which is self-extinguishing.
The radial leads are of solder-coated wire.

1. GENERAL DATA

1.1. Mounting**Normal use**

The capacitors are designed for printed wiring applications.

Specified method of mounting to withstand vibration and shock

In order to withstand vibration and shock tests, it must be ensured that the underside of the crimps are in good contact with the printed-wiring board. For case sizes up to and including a mass of 2 g the capacitors shall be mechanically fixed by the leads.

With larger case sizes the capacitors shall be mounted in the same way and the body shall be clamped.

Polyethyleneterephthalate film/foil capacitors

2222 347

1.2.1 Dimensions in mm

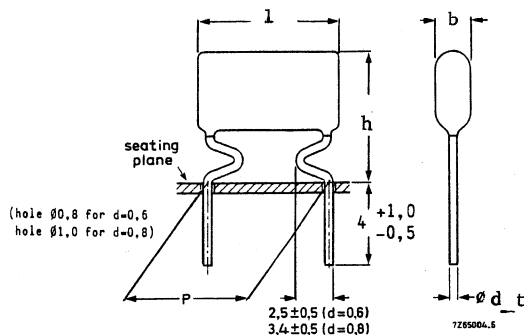

Fig. 1

Table 1 $U_{Rdc} = 100V$; max. a.c voltage = 50V, Fig. 1

capacitance μF	b_{max}	h_{max}	l_{max}	d_t	P	mass g	catalogue number 2222 347						
							C-tol $\pm 20\%$	C-tol $\pm 10\%$					
0,015	4,5	12,5	14	0,6 $+0,06$ $-0,05$	10,16 $\pm 0,3$	0,4 0,5 0,6 0,7 0,8 0,9	20153	21153					
0,018	5	12,5	14										
0,022	5,5	13	14										
0,027	5,5	13	14										
0,033	6	13,5	14										
0,039	6,5	14	14										
0,047	7	14,5	14										
0,056	5,5	14	19,5						0,8 $+0,08$ $-0,05$	15,24 $\pm 0,3$	1,2 1,3 1,5 1,7 1,9 2,3	20563	21563
0,068	6	14,5	19,5										
0,082	6,5	15	19,5										
0,10	7	15,5	19,5										
0,12	7,5	16	19,5										
0,15	8	16,5	19,5										
0,18	7,5	18	27,5	22,86 $\pm 0,3$	2,8 3,2 3,8 4,4 5,1 6,0	20184	21184						
0,22	7,5	18,5	27,5										
0,27	8	19,5	27,5										
0,33	8,5	20	27,5										
0,39	9,5	21	27,5										
0,47	10,5	22	27,5										
0,56	10	21,5	32,5					27,94 $\pm 0,3$	7,0 8,4 10,2 12,5	20564	21564		
0,68	11	22,5	32,5										
0,82	12	23,5	32,5										
1	13,5	25	32,5										

Polyethyleneterephthalate film/foil capacitors

2222 347

Table 2 $U_{Rdc} = 250V$; max. a.c. voltage = 80V, Fig. 1

capacitance μF	b_max	h_max	l_max	d_t	P	mass g	catalogue number 2222 347	
							C-tol $\pm 20\%$	C-tol $\pm 10\%$
0,0082	4,5	12	14	0,6 +0,06 -0,05	10,16 $\pm 0,3$	0,4	40822	41822
0,010	5	12,5	14			0,5	40103	41103
0,012	5,5	13	14			0,5	40123	41123
0,015	5,5	13	14			0,6	40153	41153
0,018	6	13,5	14			0,7	40183	41183
0,022	6,5	14	14			0,8	40223	41223
0,027	7	14,5	14			0,9	40273	41273
0,033	5,5	14	19,5	0,8 +0,08 -0,05	15,24 $\pm 0,3$	1,1	40333	41333
0,039	6	14,5	19,5			1,3	40393	41393
0,047	6,5	15	19,5			1,4	40473	41473
0,056	7	15,5	19,5			1,6	40563	41563
0,068	7,5	16	19,5			1,8	40683	41683
0,082	8	16,5	19,5			2,1	40823	41823
0,10	7,5	18	27,5	0,8 +0,08 -0,05	22,86 $\pm 0,3$	2,7	40104	41104
0,12	7,5	18,5	27,5			3,0	40124	41124
0,15	8	19,5	27,5			3,5	40154	41154
0,18	8,5	20	27,5			4,0	40184	41184
0,22	9,5	21	27,5			4,5	40224	41224
0,27	10,5	22	27,5			5,3	40274	41274
0,33	10	21,5	32,5	0,8 +0,08 -0,05	27,94 $\pm 0,3$	6,3	40334	41334
0,39	11	22,5	32,5			7,6	40394	41394
0,47	12	23,5	32,5			9,1	40474	41474
0,56	13,5	25	32,5			10,8	40564	41564
0,68	15	26,5	32,5			13,1	40684	41684

Polyethyleneterephthalate film/foil capacitors

2222 347

Table 3 $U_{Rdc} = 400V$; max. a.c. voltage = 125V, Fig. 1

capacitance μF	b_max	h_max	l_max	d_t	P	mass g	catalogue number 2222 347	
							C-tol $\pm 20\%$	C-tol $\pm 10\%$
0,0047	4,5	12	14	0,6 $\pm 0,06$ $-0,05$	10,16 $\pm 0,3$	0,4	50472	51472
0,0056	5	12,5	14			0,5	50562	51562
0,0068	5,5	13	14			0,5	50682	51682
0,0082	5,5	13	14			0,6	50822	51822
0,010	6	13,5	14			0,7	50103	51103
0,012	6,5	14	14			0,8	50123	51123
0,015	7	14,5	14			0,9	50153	51153
0,018	5,5	14	19,5	0,8 $\pm 0,08$ $-0,05$	15,24 $\pm 0,3$	1,1	50183	51183
0,022	6	14,5	19,5			1,2	50223	51223
0,027	6,5	15	19,5			1,4	50273	51273
0,033	7	15,5	19,5			1,6	50333	51333
0,039	7,5	16	19,5			1,8	50393	51393
0,047	8	16,5	19,5			2,1	50473	51473
0,056	7,5	18	27,5			0,8 $\pm 0,08$ $-0,05$	22,86 $\pm 0,3$	2,5
0,068	7,5	18,5	27,5	2,9	50683			51683
0,082	8	19,5	27,5	3,2	50823			51823
0,10	8,5	20	27,5	3,8	50104			51104
0,12	9,5	21	27,5	4,4	50124			51124
0,15	10,5	22	27,5	5,2	50154			51154
0,18	10	21,5	32,5	0,8 $\pm 0,08$ $-0,05$	27,94 $\pm 0,3$			6,0
0,22	11	22,5	32,5			6,9	50224	51224
0,27	12	23,5	32,5			8,0	50274	51274
0,33	13,5	25	32,5			9,5	50334	51334

Polyethyleneterephthalate film/foil capacitors

2222 347

Table 4 $U_{Rdc} = 630V$; max. a.c. voltage = 200V, Fig. 1

capacitance μF	b_max	h_max	l_max	d_t	P	mass g	catalogue number 2222 347	
							C-tol $\pm 20\%$	C-tol $\pm 10\%$
0,001	5,5	13	14			0,5	60102	61102
0,0012	5,5	13	14			0,5	60122	61122
0,0015	5,5	13	14			0,6	60152	61152
0,0018	5,5	13	14			0,7	60182	61182
0,0022	5,5	13	14			0,5	60222	61222
0,0027	5,5	13	14	0,6	10,16	0,6	60272	61272
0,0033	5,5	13	14	+0,06	$\pm 0,3$	0,5	60332	61332
0,0039	5,5	13	14	-0,05		0,6	60392	61392
0,0047	6	13,5	14			0,7	60472	61472
0,0056	6,5	14	14			0,8	60562	61562
0,0068	7	14,5	14			0,9	60682	61682
0,0082	5,5	14	19,5			1,1	60822	61822
0,010	6	14,5	19,5			1,2	60103	61103
0,012	6,5	15	19,5		15,24	1,3	60123	61123
0,015	7	15,5	19,5		$\pm 0,3$	1,5	60153	61153
0,018	7,5	16	19,5			1,7	60183	61183
0,022	8	16,5	19,5			2,0	60223	61223
0,027	7,5	18	27,5			2,5	60273	61273
0,033	7,5	18,5	27,5			2,8	60333	61333
0,039	8	19,5	27,5			3,0	60393	61393
0,047	8,5	20	27,5	0,8	22,86	3,5	60473	61473
0,056	9,5	21	27,5	+0,08	$\pm 0,3$	3,8	60563	61563
0,068	10,5	22	27,5	-0,05		4,4	60683	61683
0,082	10	21,5	32,5			5,2	60823	61823
0,1	11	22,5	32,5			6,2	60104	61104
0,12	12	23,5	32,5		27,94	7,2	60124	61124
0,15	13,5	25	32,5		$\pm 0,3$	8,7	60154	61154

Polyethyleneterephthalate film/foil capacitors

2222 347

1.2.2 Packing

The capacitors are supplied loose in box, the quantity per box is given in the table below.

dimensions (mm) b_max x h_max x l_max	Number of capacitors per box	
	SPQ	PQ
< 5,5 x 13 x 14	2000	16000
$\geq 5,5$ x 13 x 14 and $\leq 7,5$ x 16 x 19,5	2000	8000
> 7,5 x 16 x 19,5 and $\leq 7,5$ x 18,5 x 27,5	1000	4000
> 7,5 x 18,5 x 27,5 and ≤ 11 x 22,5 x 32,5	500	2000
≥ 12 x 23,5 x 32	250	1000

Polyethyleneterephthalate film/foil capacitors

2222 347

1.3. Ratings and characteristics

Unless otherwise specified all electrical values apply to an ambient free air temperature of $23 \pm 1^\circ\text{C}$, an atmospheric pressure of 86 to 106 kPa and a relative humidity of $50 \pm 2\%$.

1.3.1 Capacitance

Capacitance range at 1 kHz see Tables 1 to 4

Capacitance tolerance see Tables 1 to 4

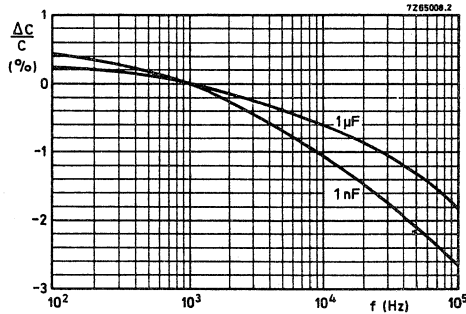

Fig. 2 : Capacitance as a function of frequency; typical curve.

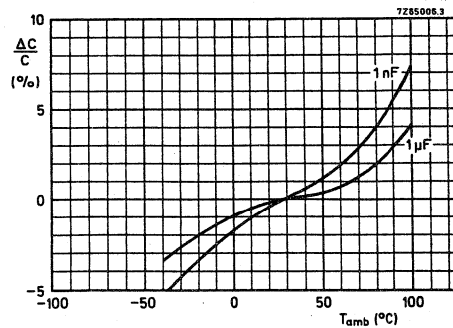

Fig. 3 : Capacitance as a function of ambient free air temperature; typical curve.

Polyethyleneterephthalate film/foil capacitors

2222 347**1.3.2 Voltage**
-----Rated voltage U_{Rdc} See Tables 1 to 4Category voltage U_C $0,8 \times U_{Rdc}$ Test voltage
between terminations (Test A)* $2 \times U_{Rdc}$ Max. a.c. voltage (r.m.s. value),
at 50 to 60 Hz see Tables 1 to 4**1.3.3 Climatic category** 40/100/21
-----**1.3.4 Rated temperature** 85°C
-----**1.3.5 Storage temperature range** Temperature -25°C to $+40^{\circ}\text{C}$
----- RH max. 80% without condensation

*IEC 384-1

Polyethyleneterephthalate film/foil capacitors

2222 347

1.3.6 Tangent of loss angle

Tan_delta at 10 kHz	$< 110 \times 10^{-4}$
Tan_delta at 1 kHz	$< 60 \times 10^{-4}$

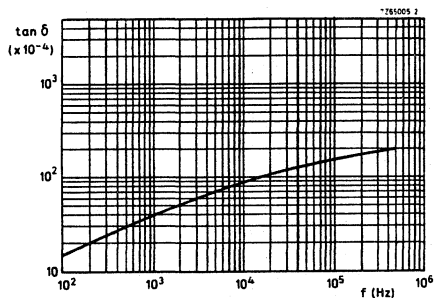

Fig. 4 : Tan_delta as a function of frequency; typical curve

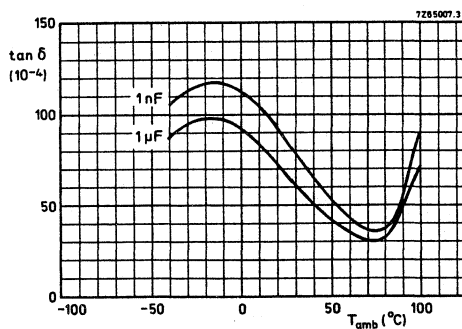

Fig. 5 : Tan_delta as a function of ambient free air temperature; typical curve. Measuring frequency is 10 kHz.

Polyethyleneterephthalate film/foil capacitors

2222 347

1.3.7 Insulation resistance at $T_{amb} = 20^{\circ}C$

The insulation resistance is measured after a voltage has been applied for 1 min. + 5 s., the voltage being 100 + 15V for the 100V, 250V and 400V versions and 500V + 50V for the 630 V version.

R between terminations, for $C \leq 0,33\mu F$ > 50.000 M Ω

RC between terminations, for $C > 0,33\mu F$ > 16.500 s.

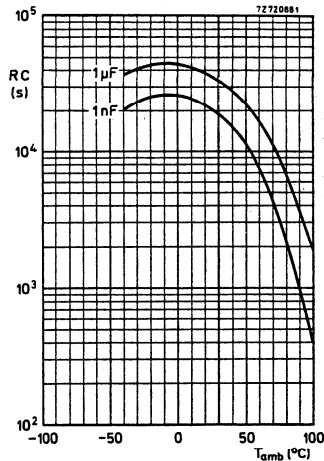

Fig. 6 : RC-product as a function of ambient free air temperature; typical curve

Polyethyleneterephthalate film/foil capacitors

2222 347

1.3.9 Maximum dissipation

The power dissipated by a capacitor is a function of the voltage U_{esr} across or the current I through the series resistance ESR and is expressed by:

$$P = \frac{U_{\text{esr}}^2}{\text{ESR}} \quad (1) \quad \text{or } P = \text{ESR} \cdot I^2 \quad (2)$$

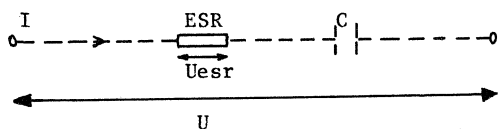

$$U_{\text{esr}}^2 = \frac{\text{ESR}^2}{\text{ESR}^2 + 1/w^2 C^2} \cdot U^2 \quad (3a)$$

As for film capacitors $\tan_{\text{delta}} = w \cdot C \cdot \text{ESR} \ll 0.1$, the formula (3a) can be simplified to

$$U_{\text{esr}}^2 = \text{ESR}^2 \cdot w^2 \cdot C^2 \cdot U^2 \quad (3b)$$

or with $\text{ESR} = \tan_{\text{delta}}/wC$, we become:

$$P = w \cdot C \cdot \tan_{\text{delta}} \cdot U^2 \quad (4) \quad \text{or } P = \frac{\tan_{\text{delta}}}{w \cdot C} I^2 \quad (5)$$

For the \tan_{delta} we can take the value found from fig.4, C is in farad and $w = 2 \cdot \pi \cdot f$.

U or I are assumed to be known.

The maximum permissible power dissipation (P_{max}), which depends on the dimensions of the capacitor and on the ambient free air temperature can be found from fig.7.

In applications where sine waves occur, we have to take for U the RMS-voltage or for I the RMS-current of the sine wave.

In applications where periodic signals occur, the signal has to be expressed in Fourier-terms:

$$U = U_0 + \sum_{k=1}^{\infty} \sin(kwt + \varphi_k) \quad (6)$$

Polyethyleneterephthalate film/foil capacitors

2222 347

$$I = \sum_{k=1}^{\infty} I_k \sin(k\omega t + \varphi_k) \quad (7)$$

with U_0 the D.C.voltage, U_k and I_k the voltage resp. current of the k-th harmonic.

We become for the dissipated power :

$$\text{with (6)} \quad P = \sum_{k=1}^{\infty} k \cdot \omega \cdot C \cdot \tan_{\Delta} \delta_k \cdot \frac{U_k^2}{2} \quad (8)$$

$$\text{with (7)} \quad P = \sum_{k=1}^{\infty} \frac{\tan_{\Delta} \delta_k \cdot I_k^2}{k \cdot \omega \cdot C \cdot 2} \quad (9)$$

and $\tan_{\Delta} \delta_k$ is the $\tan_{\Delta} \delta$ at the k-th harmonic.

Curve	Dimensions in mm		
	b_max.	h_max.	l_max.
1	4,5	12	14
2	5	12,5	14
3	5,5	13	14
4	6	13,5	14
5	6,5	14	14
6	7	14,5	14
7	5,5	14	19,5
8	6	14,5	19,5
9	6,5	15	19,5
10	7	15,5	19,5
11	7,5	16	19,5
12	8	16,5	19,5
13	6,5	18	27,5
14	7	18,5	27,5
15	8	19,5	27,5
16	8,5	20	27,5
17	9,5	21	27,5
18	10,5	22	27,5
19	10	21,5	32,5
20	11	22,5	32,5
21	12	23,5	32,5
22	13,5	25	32,5
23	15	26,5	32,5

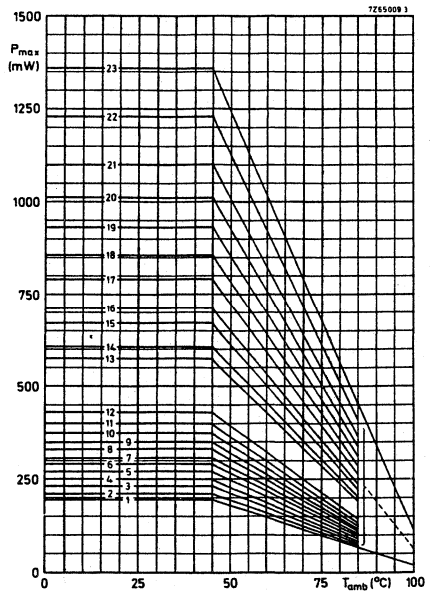

Fig. 7 Maximum permissible power dissipation as a function of ambient free air temperature.

1.3.10 Application note

To select this capacitor for a certain application you have to check 5 conditions :

1. The peak voltage (U_p) shall not be greater than the rated d.c. voltage.
2. The peak to peak voltage (U_{pp}) shall not be greater than $2\sqrt{2}$ times the rated a.c. voltage, to avoid the ionisation inception level.
3. There is no limit for the peak current (I_p) or voltage pulse slope (dU/dt) in the application.
4. The dissipated power shall not be greater than the maximum permissible power dissipation stated in 1.3.9.
5. The free air ambient temperature for the capacitor is not exceeding the category temperature.

Polyethyleneterephthalate film/foil capacitors

2222 347

Example of using Fig. 4 and 7

A capacitor of 0.1 μ F should be used at a sine voltage of 60 Vrms, a frequency of 10 kHz and an ambient free air temperature of 50°C.

The tan δ is 0.01 (from Fig.4), so that the power to be dissipated is :

$$\begin{aligned}
 P &= \omega \cdot C \cdot \tan_{\delta} \cdot U^2 \\
 &= 2\pi \cdot 10^4 \cdot 0,1 \cdot 10^{-6} \cdot 0,01 \cdot 60^2 \text{ W} \\
 &= 230 \text{ mW}
 \end{aligned}$$

For a rated voltage of 60 Vrms a capacitor of 250V range is required at least.

Capacitor 0,1 μ F/250V is satisfactory because of its dimensions 6,5 x 18 x 27,5mm and its allowed dissipated power of 525 mW at 50°C.

Checking the 5 conditions

1. The peak voltage $U_p = 85\text{V} = (\sqrt{2} \times 60\text{V})$ is lower than 250Vdc.
2. The peak to peak voltage $170U_{pp}$ is lower than 80Vac $2\sqrt{2} = 226 U_{pp}$
3. The voltage pulse slope : of no consideration.
4. The dissipated power is 230 mW.
This is less than 525 mW, allowed for a capacitor with dimensions 6,5x18,0x27,5mm as seen in fig. 7.
5. The free air ambient temperature is 50°C, and lower than 85°C.

Polyethyleneterephthalate film/foil capacitors

2222 347**1.4. Related documents**

Generic specification	IEC 384-1
Sectional specification	IEC 384-11

1.5. Marking

The capacitors are marked in black ink on the top with the following information :

- ° Capacitance in pF or μF
- ° Capacitance tolerance M : 20% K : 10% J : 5%
- ° Rated voltage (e.g. 250V)
- ° Code for dielectric material (KT)
- ° Manufacturer's name (PHILIPS)
- ° Code for factory of origin (HQ)

Example :

PHILIPS	0.39 μF 20%
	250V- KT HQ

Polyethyleneterephthalate film/foil capacitors

2222 347

The package containing the capacitors is marked as follows

Data on label SPQ and PQ
(example)

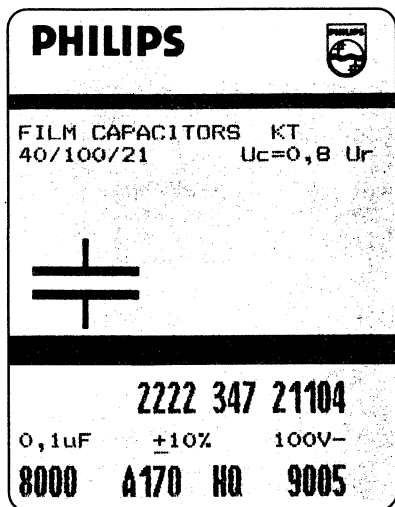

Block A : Philips word mark and emblem

Block B : Line 1 : Film capacitors and material code

Line 2 : Climatic group number and category voltage

Line 3 : Country standard

Capacitor symbol

Block C : Line 1 : Product code (12 NC)

Line 2 : Capacitance value

<10 K in pF followed by pF

>10K in μ F followed by μ F

Tolerance followed by + and %

Voltage followed by V-

Line 3 : Number of capacitors

Preference-origin code : A

Country of origin : Belgium=170

Responsible production centre :

Philips Roeselare = HQ

Production period : year- and week code (4 digits)

1.6. Ordering information

Order the capacitors by quoting the 12-digit catalogue number as shown in Tables 1 to 4.

1.7. Certified test records (CTR)

Not required.

2. INSPECTION REQUIREMENTS

Note 1 : Sub-clause numbers of tests and performance requirements refer to the Sectional Specification, IEC-publication 384-11 and Section One of this specification.

Note 2 : Inspection levels and AQL's are selected from IEC-Publication 410 : Sampling Plans and Procedures for Inspection by attributes.

Note 3 : In this table :

- p = periodicity (in months)
- n = sample size
- c = acceptance criterion (permitted number of defectives)
- D = destructive
- ND = non-destructive
- IL = inspection level) IEC 410
- AQL = acceptable quality level)

Note 4 : For this capacitor, considered as a solid construction, it is permitted to reduce the periodicity of the vibration and shock test from 6 months to 36 months.
In the event of a single defective occurring in subgroup Clb at this reduced rate of testing, then the vibration and shock tests shall revert to a 6 monthly periodicity until three successive 6-monthly tests shall have produced no defectives.

Polyethyleneterephthalate film/foil capacitors

2222 347

Clause number and Test (see Note 1)	D or ND	Conditions of Test (see Note 1)	IL (see Note 2)	AQL	Performance requirements (see Note 1)
<u>Group A Inspection (lot-by-lot)</u>					
<u>Sub-group A1</u>					
4.1 Visual examination	ND		I	2,5%	- No mechanical failures - Legible marking and as specified in GENERAL DATA of this specification.
4.2 Dimensions		Gauging			- As specified in Tables 1 to 4 of this specification.
<u>Sub-group A2</u>					
4.2.1 Voltage proof (Test A)	ND	at $2,2xU_{Rdc}$ for 1 s.	I	1%	- No breakdown or flashover
4.2.2 Capacitance		at 1kHz			- Within specified tolerance

Polyethyleneterephthalate film/foil capacitors

2222 347

Sub-clause number and Test (see Note 1)	D or ND	Conditions of test (see Note 1)	Sample size + criterion of accepta- bility (see Note 3)			Performance requirements
			p	n	c	
<hr/>						
<u>Group C inspection</u> (periodic)						
<u>Sub-group C1A</u>						
Part of sample of Sub-group C1						
4.1 Dimensions (detail)	D		6	9	1	As specified in Tables 1 to 4 of this specification
4.3.1 Initial measurements		Capacitance at 1kHz Tangent of loss angle at 10 kHz				
4.3 Robustness of terminations		Tensile and bending				No visible damage
4.4 Resistance to soldering heat		No pre-drying Methode : 1A Solder bath : 260°C Duration : 10 s				
4.4.2 Final measurements		Visual examination Capacitance				No visible damage Legible marking $\frac{\Delta C}{C} < 2\%$ of the va- lue measured in 4.3.1.

Polyethyleneterephthalate film/foil capacitors

2222 347

Sub-clause number and Test (see Note 1)	D or ND	Conditions of test (see Note 1)	Sample size + criterion of accepta- bility (see Note 3)			Performance requirements
			p	n	c	
<u>Sub-group ClB</u> Other part of sample of Sub-group Cl	D		6	18	1	
4.6.1 Initial measurements		Capacitance at 1kHz Tangent of loss angle at 10 kHz				
4.6 Rapid change of temperature		θ_A =lower cat. temp. θ_B =upper cat. temp. 5 cycles Duration t = 30min. Visual examination				No visible damage
4.7 Vibration (see Note 4)		Method of mounting see GENERAL DATA of this specification. Procedure B4. Frequency range : 10Hz to 55Hz. Pulse shape : half sine Amplitude 0,75mm or acceleration 98m/s ² (whichever is the less severe) Total duration 6h				
4.7.2 Final inspection		Visual examination				No visible damage
4.9 Shock (see Note 4)		Method of mounting see GENERAL DATA of this specification Accelerat.:490m/s ² Duration of pulse : 11ms				
4.9.3 Final measurements		Visual examination Capacitance Tangent of loss angle				No visible damage $\Delta \frac{C}{C} \leq 2\%$ of the va- lue measured in 4.6.1 As in GENERAL DATA of this specifica- tion.

Polyethyleneterephthalate film/foil capacitors

2222 347

Sub-clause number and Test (see Note 1)	D or ND	Conditions of test (see Note 1)	Sample size + criterion of accepta- bility (see Note 3)			Performance requirements
			p	n	c	
<u>Sub-group C1</u>	D		6	27	2	
Combined sample of spe- cimens of Sub-groups C1A and C1B						
4.10 Climatic sequence						
4.10.2 Dry heat		Temperature : upper category temperature Duration : 16h				
4.10.3 Damp heat cyclic, Test Db, first cycle						
4.10.4 Cold		Temperature : lower category temper. Duration : 2h				
4.10.6 Damp heat cyclic, Test Db remaining cycles						
4.10.6.2 Final measurements		Visual examination Capacitance Tangent of loss angle Insulation resis- tance.				No visible damage Legible marking $\Delta \frac{C}{C} < 5\%$ of value C measured in 4.4.2. or 4.8.3. As in GENERAL DATA of this specification. >50% of values in GENERAL DATA of this specification

Polyethyleneterephthalate film/foil capacitors

2222 347

Sub-clause number and Test (see Note 1)	D or ND	Conditions of test (see Note 1)	Sample size + criterion of accepta- bility (see Note 3)			Performance requirements
			p	n	c	
<u>Sub-group C2</u>			6	15	1	
4.11 Damp heat steady state	D					
4.11.1 Initial measurements		Capacitance at 1 kHz Tangent of loss angle at 10 kHz				
4.11.3 Final measurements		Visual examination Capacitance Tangent of loss angle Insulation resis- tance				No visible damage Legible marking $\Delta \frac{C}{C} < 5\%$ of value C measured in 4.11.1 As in GENERAL DATA of this specification. >50% of values in GENERAL DATA of this specification
<u>Sub-group C3</u>			3	21	1	
4.12 Endurance	D	Duration : 1000 h 1,5 U _{Rdc} at 85°C 1,5 U _C at 100°C				
4.12.1 Initial measurements		Capacitance at 1kHz Tangent of loss angle at 10 kHz				
4.12.5 Final measurements		Visual examination Capacitance Tangent of loss angle Insulation resis- tance				No visible damage Legible marking $\Delta \frac{C}{C} < 10\%$ of value C measured in 4.12.1 As in GENERAL DATA of this specification. >50% of values in GENERAL DATA of this specification

Polyethyleneterephthalate film/foil capacitors

2222 347

Additional tests	D or ND	Conditions of test	Sample size + criterion of accepta- bility			Performance requirements
			p	n	c	
<hr/>						
<u>Sub-group ADD1</u> A.1 Solderability	D	Without ageing Method : 1 Non-activated colo- phany flux 501 Solder bath 235°C Dwell time : 2 s.	3	35	1	Good tinning as evidenced by free flowing of the solder with wet- ting of the ter- minations (>95%)
<hr/>						
<u>Sub-group ADD2</u> A.2 Heat storage	D	Duration : 1000h Temperature : upper category temperature	3	12	1	$\Delta C < 5\%$ of value \bar{C} measured in A.2.1 As in GENERAL DATA of this specifica- tion. As in GENERAL DATA of this specifica- tion.
A.2.1 Initial measurements		Capacitance at 1 kHz Tangent of loss angle at 10 kHz				
A.2.2 Final measurements		Capacitance Tangent of loss angle Insulation resis- tance				
<hr/>						
<u>Sub-group ADD3</u> A.3 Endurance for capacitors with max. a.c. voltage ≥ 200 V		Duration : 1000h Temperature : 85°C Voltage:1,25xmax. a.c. voltage (r.m.s. value) 50 Hz	3	9	1	$\Delta C < 5\%$ of value \bar{C} measured in A.3.1 As in GENERAL DATA of this specifica- tion As in GENERAL DATA of this specifica- tion.
A.3.1 Initial measurements		Capacitance at 1 kHz Tangent of loss angle at 10 kHz				
A.3.2 Final measurements		Capacitance Tangent of loss angle Insulation resis- tance				

Polyethyleneterephthalate film/foil capacitors

2222 347

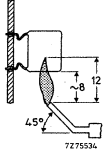
Additional tests	D or ND	Conditions of test	Sample size + criterion of accepta- bility			Performance requirements
			p	n	c	
<hr/>						
<u>Sub-group ADD4</u>	D		6	15	1	
A.4 Resistance to soldering heat with pre-heating.		Capacitors mounted on a 1,6mm board with nonplated holes Body temp. : 80°C Bath temp. : 260°C Dwell time : 2x5s with interim free period of 5s.				
A.4.1 Initial measurements		Capacitance Tangent of loss angle				
A.4.2 Final measurements		Capacitance Tangent of loss angle Insulation resistance.				$\frac{\Delta C}{C} < 2\%$ of value measured in A.4.1 As in GENERAL DATA of this specification. As in GENERAL DATA of this specification.
<hr/>						
<u>Sub-group ADD5</u>	D		6	15	1	
A.5.1 Needle flame test IEC-695-2-2		Bore of gas jet : ϕ 0,5 mm Fuel : butane Test duration : 20s. One flame application. 				After removing the test flame from the capacitor, the capacitor must not continue to burn for more than 15s., no burning particles must drop from the sample.

Philips Components

Data sheet	
status	Product specification
date of issue	May 1990

2222 344

Metallized polycarbonate film capacitors

MKC Radial potted type

- ° 10 to 27,5mm terminal pitch
- ° Supplied loose in box and taped on reel

QUICK REFERENCE DATA

Capacitance range (E12-series)	0,010 to 6,8 μ F
Capacitance tolerance	<u>+20%</u> , <u>+10%</u> , <u>+5%</u>
Rated voltage U _{Rdc}	100V, 250V, 400V, 630V
Climatic category	55/100/56
Rated temperature	85°C
Tangent of loss angle at 10kHz	20 x 10 ⁻⁴
Related specification	IEC 384-6
Performance grade	Grade 1 (long life)

Metallized polycarbonate film capacitors

2222 344

SURVEY OF STYLES

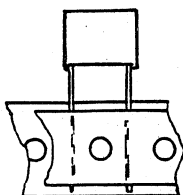

style : 2222 344
pitch : 10mm, 15mm
tables 1 to 4

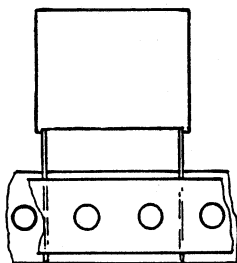
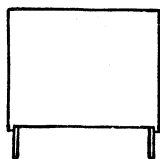

style : 2222 344
pitch : 22,5mm, 27,5mm
tables 1 to 4

CONSTRUCTION

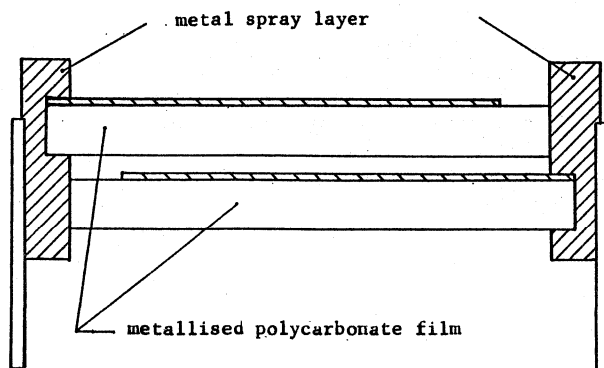

Metallized polycarbonate film capacitors

2222 344

APPLICATION

In electronic circuits for blocking and coupling, bypass and energy reservoir applications. Their defined dimensions make them extremely suitable for circuits with high packaging density.

DESCRIPTION

The capacitors consist of a low-inductive wound cell of metallized polycarbonate (PC) film. The cell is potted with epoxy resin in a blue flame retardant case. The radial leads are of solder-coated wire. The capacitors can withstand solvents and rinsing liquids without damage. They have small stand-off pips to allow removal of solder flux etc., during cleaning of the printed-wiring board.

1. GENERAL DATA

1.1. Mounting

Normal use

The capacitors are designed for printed wiring applications.

The capacitors packed in bandoliers are designed for mounting on printed-wiring boards by means of automatic insertion machines.

Specific method of mounting to withstand vibration and shock

In order to withstand vibration and shock tests, it must be insured that the stand-off pips are in good contact with the printed-wiring board. For case sizes up to and including a mass of 6 g the capacitors shall be mechanically fixed by the leads.

With larger case sizes the capacitors shall be mounted in the same way and the body shall be clamped.

Metallized polycarbonate film capacitors

2222 344

1.2.1 Dimensions in mm

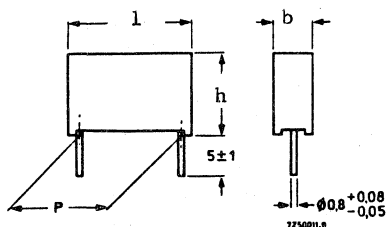

Fig. 1

Table 1 $U_{Rdc} = 100V$; max. a.c. voltage = 63V

capacitance μF	b_{max}	h_{max}	l_{max}	P	mass g	catalogue number 2222 344					
						loose in box Fig.1			taped on reel Fig.2-3		
						C tol + 20%	C tol + 10%	C tol ± 5%	C tol + 20%	C tol + 10%	C tol + 5%
0,082	4,5	10	13			20823	21823	22823	27823	28823	29823
0,10	4,5	10	13			20104	21104	22104	27104	28104	29104
0,12	4,5	10	13		0,7	20124	21124	22124	27124	28124	29124
0,15	4,5	10	13	$10 \pm 0,3$		20154	21154	22154	27154	28154	29154
0,18	5	11	13		0,85	20184	21184	22184	27184	28184	29184
0,22	5	11	13			20224	21224	22224	27224	28224	29224
0,27	5	11	17,5		1,05	20274	21274	22274	27274	28274	29274
0,33	5	11	17,5			20334	21334	22334	27334	28334	29334
0,39	5	11	17,5			20394	21394	22394	27394	28394	29394
0,47	5	11	17,5			20474	21474	22474	27474	28474	29474
0,56	6	12	17,5	$15 \pm 0,3$	1,4	20564	21564	22564	27564	28564	29564
0,68	6	12	17,5			20684	21684	22684	27684	28684	29684
0,82	7	13	17,5		1,8	20824	21824	22824	27824	28824	29824
1,0	7	13	17,5			20105	21105	22105	27105	28105	29105
1,2	6,5	15,5	26		2,75	20125	21125	22125	27125	28125	29125
1,5	6,5	15,5	26			20155	21155	22155	27155	28155	29155
1,8	8,5	17,5	26	$22,5 \pm 0,3$	4,3	20185	21185	22185	27185	28185	29185
2,2	8,5	17,5	26			20225	21225	22225	27225	28225	29225
2,7	9,5	19	26		5,1	20275	21275	22275	27275	28275	29275
3,3	9,5	19	26			20335	21335	22335	27335	28335	29335
3,9	11	20	31		7,4	20395	21395	22395	27395	28395	29395
4,7	11	20	31			20475	21475	22475	27475	28475	29475
5,6	13	22,5	31	$27,5 \pm 0,3$	10,2	20565	21565	22565	27565	28565	29565
6,8	13	22,5	31			20685	21685	22685	27685	28685	29685

Metallized polycarbonate film capacitors

2222 344

Table 2 $U_{Rdc} = 250V$; max. a.c. voltage = 160V

capacitance μF	b_{max}	h_{max}	l_{max}	P	mass g	catalogue number 2222 344					
						loose in box Fig.1			taped on reel Fig.2-3		
						C tol +20%	C tol +10%	C tol \pm 5%	C tol +20%	C tol +10%	C tol \pm 5%
0,039	4,5	10	13			44393	45393	43393	47393	48393	49393
0,047	4,5	10	13			44473	45473	43473	47473	48473	49473
0,056	4,5	10	13	$10 \pm 0,3$	0,7	44563	45563	43563	47563	48563	49563
0,068	4,5	10	13			44683	45683	43683	47683	48683	49683
0,082	5	11	17,5		1,05	44823	45823	43823	47823	48823	49823
0,10	5	11	17,5			44104	45104	43104	47104	48104	49104
0,12	5	11	17,5	$15 \pm 0,3$		44124	45124	43124	47124	48124	49124
0,15	5	11	17,5			44154	45154	43154	47154	48154	49154
0,18	6	12	17,5		1,4	44184	45184	43184	47184	48184	49184
0,22	6	12	17,5			44224	45224	43224	47224	48224	49224
0,27	7	13	17,5		1,8	44274	45274	43274	47274	48274	49274
0,33	7	13	17,5			44334	45334	43334	47334	48334	49334
0,39	6,5	15,5	26		2,75	44394	45394	43394	47394	48394	49394
0,47	6,5	15,5	26			44474	45474	43474	47474	48474	49474
0,56	7,5	16,5	26	$22,5 \pm 0,3$	3,5	44564	45564	43564	47564	48564	49564
0,68	7,5	16,5	26			44684	45684	43684	47684	48684	49684
0,82	9,5	19	26		5,1	44824	45824	43824	47824	48824	49824
1,0	9,5	19	26			44105	45105	43105	47105	48105	49105
1,2	11	20	31		7,4	44125	45125	43125	47125	48125	49125
1,5	11	20	31			44155	45155	43155	47155	48155	49155
1,8	13	22,5	31	$27,5 \pm 0,3$	10,2	44185	45185	43185	47185	48185	49185
2,2	13	22,5	31			44225	45225	43225	47225	48225	49225

Metallized polycarbonate film capacitors

2222 344

Table 3 $U_{Rdc} = 400V$; max. a.c. voltage = 220V

capacitance μF	b_max	h_max	l_max	P	mass g	catalogue number 2222 344						
						loose in box Fig.1			taped on reel Fig.2-3			
						C tol + 20%	C tol + 10%	C tol ± 5%	C tol + 20%	C tol + 10%	C tol ± 5%	
0,010	4,5	10	13	$10 \pm 0,3$	0,7	50103	51103	52103	57103	58103	59103	
0,012	4,5	10	13			50123	51123	52123	57123	58123	59123	
0,015	4,5	10	13			50153	51153	52153	57153	58153	59153	
0,018	4,5	10	13			50183	51183	52183	57183	58183	59183	
0,022	4,5	10	13			50223	51223	52223	57223	58223	59223	
0,027	4,5	10	13			50273	51273	52273	57273	58273	59273	
0,033	4,5	10	13			50333	51333	52333	57333	58333	59333	
0,039	5	11	17,5	$15 \pm 0,3$	1,05	50393	51393	52393	57393	58393	59393	
0,047	5	11	17,5			50473	51473	52473	57473	58473	59473	
0,056	5	11	17,5			50563	51563	52563	57563	58563	59563	
0,068	5	11	17,5			50683	51683	52683	57683	58683	59683	
0,082	6	12	17,5			1,4	50823	51823	52823	57823	58823	59823
0,10	6	12	17,5			50104	51104	52104	57104	58104	59104	
0,12	7	13	17,5			1,8	50124	51124	52124	57124	58124	59124
0,15	7	13	17,5	50154	51154	52154	57154	58154	59154			
0,18	6,5	15,5	26	$22,5 \pm 0,3$	2,75	50184	51184	52184	57184	58184	59184	
0,22	6,5	15,5	26			50224	51224	52224	57224	58224	59224	
0,27	7,5	16,5	26			3,5	50274	51274	52274	57274	58274	59274
0,33	7,5	16,5	26			50334	51334	52334	57334	58334	59334	
0,39	9,5	19	26			5,1	50394	51394	52394	57394	58394	59394
0,47	9,5	19	26			50474	51474	52474	57474	58474	59474	
0,56	11	20	31			7,4	50564	51564	52564	57564	58564	59564
0,68	11	20	31	$27,5 \pm 0,3$	10,2	50684	51684	52684	57684	58684	59684	
0,82	13	22,5	31			50824	51824	52824	57824	58824	59824	
1,0	13	22,5	31			50105	51105	52105	57105	58105	59105	

Metallized polycarbonate film capacitors

2222 344

Table 4 $U_{Rdc} = 630V$; max. a.c. voltage = 220V

capacitance μF	b_max	h_max	l_max	P	mass g	catalogue number 2222 344					
						loose in box Fig.1			taped on reel Fig.2-3		
						C_tol + 20%	C_tol + 10%	C_tol + 5%	C_tol + 20%	C_tol + 10%	C_tol + 5%
0,010	4,5	10	13		0,7	60103	61103	62103	67103	68103	69103
0,012	5	11	13		0,85	60123	61123	62123	67123	68123	69123
0,015	5	11	13			60153	61153	62153	67153	68153	69153
0,018	6	12	13	$10 \pm 0,3$	1	60183	61183	62183	67183	68183	69183
0,022	6	12	13			60223	61223	62223	67223	68223	69223
0,027	6	12	17,5		1,4	60273	61273	62273	67273	68273	69273
0,033	6	12	17,5			60333	61333	62333	67333	68333	69333
0,039	7	13	17,5	$15 \pm 0,3$	1,8	60393	61393	62393	67393	68393	69393
0,047	7	13	17,5			60473	61473	62473	67473	68473	69473
0,056	8,5	14,5	17,5		2,55	60563	61563	62563	67563	68563	69563
0,068	8,5	14,5	17,5			60683	61683	62683	67683	68683	69683
0,082	6,5	15,5	26		2,75	60823	61823	62823	67823	68823	69823
0,10	6,5	15,5	26			60104	61104	62104	67104	68104	69104
0,12	7,5	16,5	26	$22,5 \pm 0,3$	3,5	60124	61124	62124	67124	68124	69124
0,15	7,5	16,5	26			60154	61154	62154	67154	68154	69154
0,18	9,5	19	26		5,1	60184	61184	62184	67184	68184	69184
0,22	9,5	19	26			60224	61224	62224	67224	68224	69224
0,27	11	20	31		7,4	60274	61274	62274	67274	68274	69274
0,33	11	20	31	$27,5 \pm 0,3$		60334	61334	62334	67334	68334	69334
0,39	13	22,5	31		10,2	60394	61394	62394	67394	68394	69394
0,47	13	22,5	31			60474	61474	62474	67474	68474	69474

Metallized polycarbonate film capacitors**2222 344****1.2.2 Packing**

The capacitors are supplied loose in box or taped on reel, details of quantities are given in Tables 5 to 7.

loose in box**Table 5 : Number of capacitors per box.**

l_max mm	Number of capacitors per box	
	SPQ	PQ
13	1000	4000
17,5	1000	4000
26	200	1000
31	100	500

Metallized polycarbonate film capacitors

2222 344

Taped on reel

1. Dimensions of taped products

Capacitors with pitch P = 10 or 15mm, Fig. 2

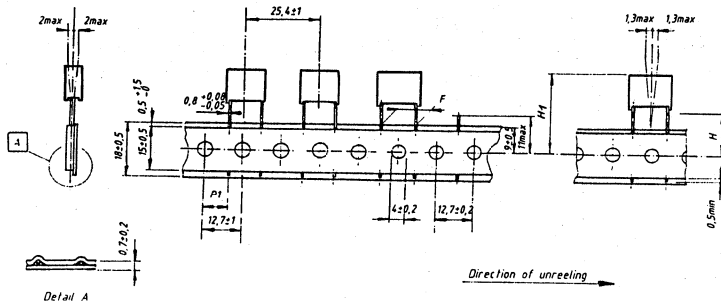

FOR PHYSICAL DIMENSIONS SEE PRODUCT SPECIFICATION

ITEM	SYMBOL	VALUE	VALUE	TOLERANCE
Lead to lead distance	F	10	15	+0,5/-0,1
Height of comp. from tape center to sealing plane	H		10,5	±0,5
Component height from tape center	H1	max 32	max 35	for h1 = 10,5
Feed hole to lead center	P1	7,7	5,2	±0,7

Capacitors with pitch P = 22,5 or 27,5mm, Fig. 3

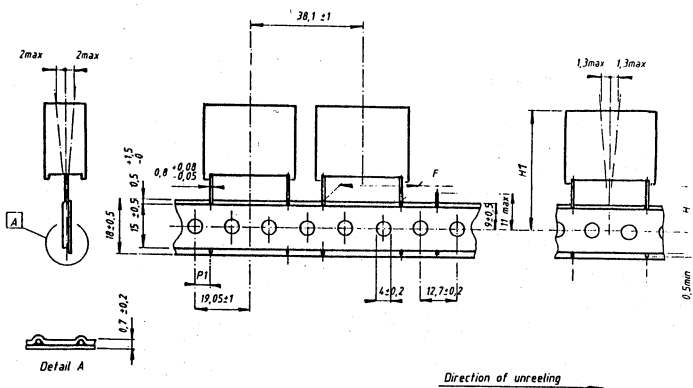

FOR PHYSICAL DIMENSIONS SEE PRODUCT SPECIFICATION

ITEM	SYMBOL	VALUE	VALUE	TOLERANCE
Lead to lead distance	F	22,5	27,5	+0,5/-0,1
Height of component from tape center to sealing plane	H		10,5	±0,5
Component height from tape center	H1	max 40	max 48	for h1=10,5
Feed hole to lead center	P1	7,8	5,33	±0,7

Metallized polycarbonate film capacitors

2222 344

2. Characteristics of taped products.

Pull-out force of the component	> 5N
Pull-off force of the adhesive tape	> 6N
Tearing force of tape	> 15N
Storage conditions	
storage temperature	-25°C to +40°C
relative humidity	max. 80% without condensation

3. Outlines of reel packing.

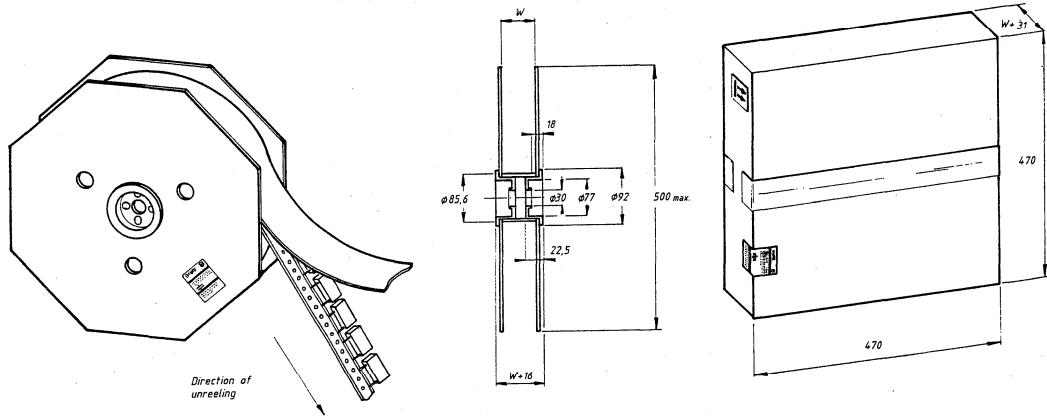

Fig. 4

Metallized polycarbonate film capacitors**2222 344****4. Number of capacitors per reel**Table 6 : l_{\max} 13 or 17,5 mm

b_{\max}	Number per reel	$W + 2\text{mm}$
4,5	1200	45
5	1100	45
6	900	45
7	800	45
8,5	650	50

Table 7 : l_{\max} 26 or 31mm

b_{\max}	Number per reel	$W + 2\text{mm}$
6,5	600	50
7,5	550	50
8,5	450	50
9,5	400	50
11	300	55
13	250	55

The max. number of empty places per reel shall not exceed 0,5% of the total number of components per reel, but a max. of 2 consecutive components may be missing provided this gap is followed by 6 consecutive components.

Metallized polycarbonate film capacitors

2222 344

1.3. Ratings and characteristics

Unless otherwise specified all electrical values apply to an ambient free air temperature of $23 \pm 1^\circ\text{C}$, an atmospheric pressure of 86 106kPa and a relative humidity of $50 \pm 2\%$.

1.3.1 Capacitance

Capacitance range at 1 kHz see Tables 1 to 4

Capacitance tolerance see Tables 1 to 4

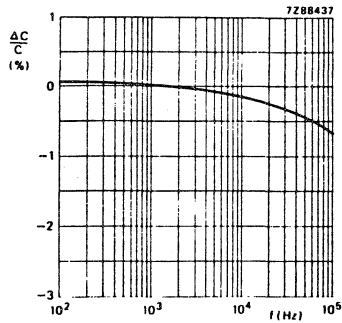

Fig. 5 : Capacitance as a function of frequency; typical curve.

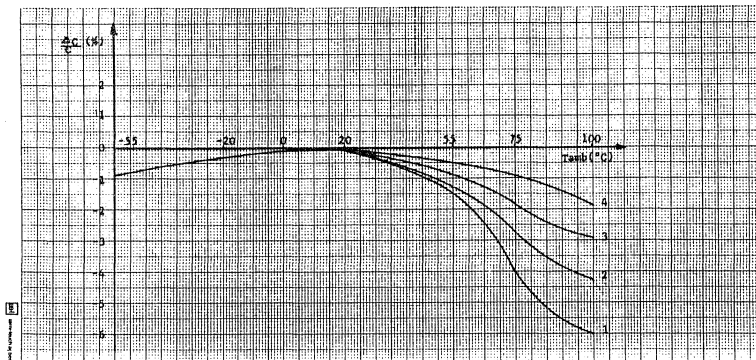

Fig. 6 : Capacitance as a function of ambient free air temperature, measured at 1kHz, typical curves.
 1. 100V series
 2. 250V series
 3. 400V series
 4. 630V series

Metallized polycarbonate film capacitors

2222 344**1.3.2 Voltage**

Rated voltage U_{Rdc}	See Tables 1 to 4
Category voltage U_C	$0,8 \times U_{Rdc}$
Test voltage between terminations	$1,6 \times U_{Rdc}$
between interconnected terminations and case(foil method)	$2 \times U_{Rdc}$; min. 200V
Max. a.c. voltage (r.m.s. value), at 50 to 60 Hz	See Tables 1 to 4
1.3.3 Climatic category	55/100/56
1.3.4 Rated temperature	85°C
1.3.5 Storage temperature range	Temperature -25°C to +40°C RH max. 80% without condensation

Metallized polycarbonate film capacitors

2222 344

1.3.6 Tangent of loss angle

Capacitance	Tangent of loss angle		
	1 kHz	10 kHz	100 kHz
$C < 0,1\mu\text{F}$	$< 30 \times 10^{-4}$	$< 60 \times 10^{-4}$	$\leq 130 \times 10^{-4}$
$0,1\mu\text{F} < C < 1\mu\text{F}$	$< 30 \times 10^{-4}$	$< 60 \times 10^{-4}$	
$C > 1\mu\text{F}$	$< 30 \times 10^{-4}$	$< 75 \times 10^{-4}$	

Fig. 7 : Tan delta as a function of frequency; typical curve

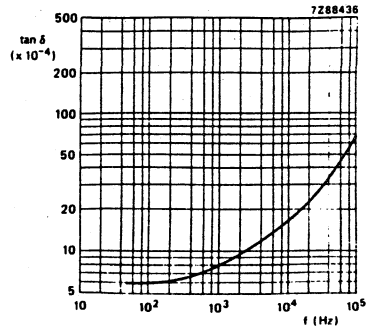

1.3.7 Rated voltage pulse slope ($\frac{dU}{dt}$) R

Rated voltage V	Maximum pulse load(V/μs)			
	l=13mm	l=17,5mm	l=26mm	l=31mm
100	60	26	12	9
250	90	36	16	14
400	140	60	26	22
630	200	90	36	30

The maximum pulse load values in the table are valid for pulse voltages equal to the rated voltage.

For lower pulse voltages the given values may be multiplied by U_{Rdc} applied voltage.

Metallized polycarbonate film capacitors

2222 344

1.3.8 Insulation resistance at $T_{amb. 20^{\circ}C}$

The insulation resistance is measured after a voltage has been applied for 1 min. \pm 5 s., the voltage being 100 \pm 15V for the 100V, 250V and 400V versions and 500 \pm 50V for the 630V version.

R between terminations, for $C \leq 0,33\mu F$

100V version	> 15 000 M Ω
250V, 400V and 630V version	> 30 000 M Ω

RC between terminations, for $C > 0,33\mu F$

100V version	> 5 000 s
250V, 400V and 630V version	> 10 000 s

R between interconnected terminations and case > 30 000 M Ω
(foil method)

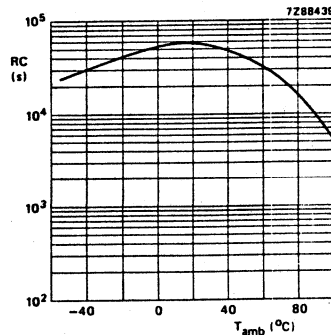
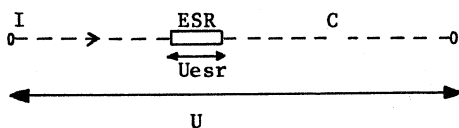

Fig. 8 : RC-product as a function of ambient free air temperature; typical curve.

1.3.9 Maximum dissipation

The power dissipated by a capacitor is a function of the voltage U_{esr} across or the current I through the series resistance ESR and is expressed by:

$$P = \frac{U_{esr}^2}{ESR} \quad (1) \quad \text{or } P = ESR \cdot I^2 \quad (2)$$



$$U_{esr}^2 = \frac{ESR^2}{ESR^2 + 1/w^2 C^2} \cdot U^2 \quad (3a)$$

As for film capacitors $\tan_{\Delta} = w \cdot C \cdot ESR \ll 0,1$, the formula (3a) can be simplified to

$$U_{esr}^2 = ESR^2 \cdot w^2 \cdot C^2 \cdot U^2 \quad (3b)$$

or with $ESR = \tan_{\Delta} / wC$, we become:

$$P = w \cdot C \cdot \tan_{\Delta} \cdot U^2 \quad (4) \quad \text{or } P = \frac{\tan_{\Delta}}{w \cdot C} I^2 \quad (5)$$

For the \tan_{Δ} we can take the value found from fig.7, C is in farad and $w = 2 \cdot \pi \cdot f$.

U or I are assumed to be known.

The maximum permissible power dissipation (P_{max}), which depends on the dimensions of the capacitor and on the ambient free air temperature can be found from fig.9.

In applications where sine waves occur, we have to take for U the RMS-voltage or for I the RMS-current of the sine wave.

In applications where periodic signals occur, the signal has to be expressed in Fourier-terms:

$$U = U_0 + \sum_{k=1}^{\infty} \sin(kwt + \varphi_k) \quad (6)$$

Metallized polycarbonate film capacitors

2222 344

$$I = \sum_{k=1}^{\infty} I_k \sin(k\omega t + \varphi_k) \quad (7)$$

with U_0 the D.C.voltage, U_k and I_k the voltage resp. of the k-th harmonic.

We become for the dissipated power :

$$\text{with (6)} \quad P = \sum_{k=1}^{\infty} k \cdot w \cdot C \cdot \tan_{\Delta} \Delta_k \frac{U_k^2}{2} \quad (8)$$

$$\text{with (7)} \quad P = \sum_{k=1}^{\infty} \frac{\tan_{\Delta} \Delta_k \cdot I_k^2}{k \cdot w \cdot C \cdot 2} \quad (9)$$

and $\tan_{\Delta} \Delta_k$ is the \tan_{Δ} at the k-th harmonic.

Curve	Dimensions (mm)		
	b_max	h_max	l_max
1	4,5	10	13
2	5	11	13
3	6	12	13
4	5	11	17,5
5	6	12	17,5
6	7	13	17,5
7	8,5	14,5	17,5
8	6,5	15,5	26
9	7,5	16,5	26
10	8,5	17,5	26
11	9,5	19	26
12	11	20	31
13	13	22,5	31

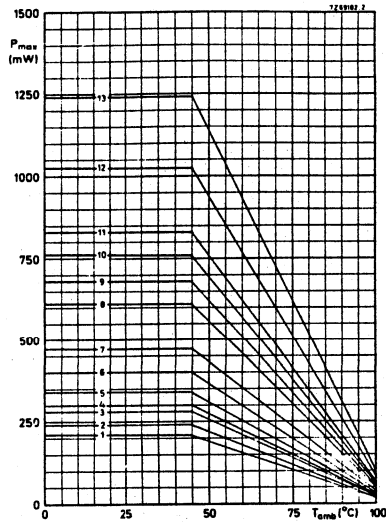

Fig.9 : Maximum permissible power dissipation as a function of ambient free air temperature.

Metallized polycarbonate film capacitors

2222 3441.3.10 Application note

To select this capacitor for a certain application you have to check 6 conditions :

1. The peak voltage (U_p) shall not be greater than the rated d.c. voltage.
2. The peak to peak voltage (U_{pp}) shall not be greater than $2\sqrt{2}$ times the rated a.c. voltage to avoid the ionisation inception level.
3. The peak current (I_p) shall not exceed the maximum peak current, defined as maximum voltage pulse slope (dU/dt) multiplied by the capacitance.

$$I_p \text{ max} = C \left(\frac{dU}{dt} \right) \text{ max.}$$

Or the voltage pulse slope shall not exceed the rated voltage pulse slope.
If the pulse voltage is lower than the rated voltage, the values of tabel 1.3 may be multiplied by U_{Rdc} and divided by applied voltage.

4. The dissipated power shall not be greater than the maximum permissible power dissipation stated in 1.3.9.
5. The free air ambient temperature for the capacitor is not exceeding the rated temperature.
6. Since all metallised film capacitors have always intrinsically active flammability risk, it is recommended to use these capacitors only in these circuits where in case of failure of the capacitor the power can be limited to less than 5 VA to the capacitor.

Metallized polycarbonate film capacitors
2222 344

Example : C = 1 μ F used for the following voltage signal

A sinewave signal with an a.c. voltage of 130V at 1kHz frequency.

In case of capacitor failure, the power is switched off.
The ambient temperature is 50°C.

Can a 1 μ f/250Vdc/160Vac be used for this application?

Checking the 6 conditions

1. The peak voltage $U_p = 183 (\sqrt{2} \times 130)$ is lower than 250Vdc.
2. The peak to peak voltage $367U_{pp}$ is lower than 160Vac $2\sqrt{2} = 452 U_{pp}$
3. Because of the sinewave, we have not to check the pulse conditions.
4. The dissipated power is :

$$P = W.C. \tan_{\Delta} V^2 \quad (\tan_{\Delta} = 8.10^{-4} \text{ from fig. 7})$$

$$= 2.1 \times 1000 \cdot 1 \cdot 10^{-6} \cdot 8.10^{-4} \cdot (130)^2 = 85\text{mW}$$

This is less than 755mW at 50°C for its dimensions
9,5 x 19,0 x 26, seen in fig. 9.

5. The free air ambient temperature is 50°C, and lower than 70°C.
6. In case of failure, the power is switched off.

Metallized polycarbonate film capacitors

2222 344**1.4. Related documents**

Generic specification	IEC 384-1
Sectional specification	IEC 384-6

1.5. MarkingCapacitors with l_{max} 13 or 17,5mm

The capacitors are marked on the top by embossed print with the following information :

- ° Capacitance in μF
- ° Rated voltage (e.g. 400)
- ° Capacitance tolerance (e.g. 20)
- ° Last eight digits of catalogue number

Example : |0.039/20/400
 |344 50393

Capacitors with l_{max} 26 or 31mm

The capacitors are marked on the top by laser print with the following information :

- ° Capacitance n : nF μ : μF
- ° Rated voltage (e.g. 100V)
- ° Capacitance tolerance M : 20% K : 10% J : 5%
- ° Manufacturer's type designation (e.g. 344)
- ° Code for dielectric material (MKC)
- ° Manufacturer's name (PHILIPS)
- ° Year and week of manufacture (e.g. 9010)
- ° Code for factory of origin (HQ)

Examples : 1 μ 2 M 100V PHILIPS
 344 MKC HQ 9010

Metallized polycarbonate film capacitors

2222 344

The package containing the capacitors is marked as follows

Data on label SPQ and PQ
(example)

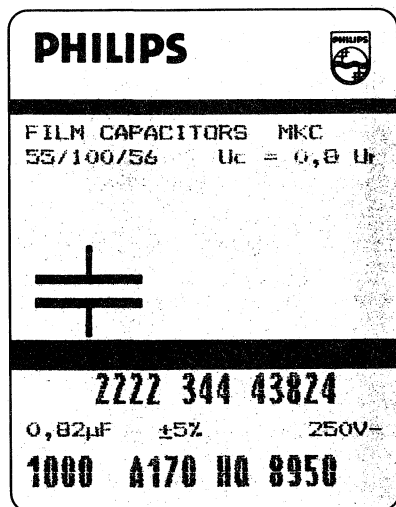

Block A : Philips word mark and emblem

Block B : Line 1 : Film capacitors and material code

Line 2 : Climatic group number and category voltage

Capacitor symbol

Block C : Line 1 : Product code (12 NC)

Line 2 : Capacitance value in μF followed by μF
Tolerance followed by \pm and %
Voltage followed by V-

Line 3 : Number of capacitors
Preference-origin code : A
Country of origin : Belgium=170
Responsible production centre : Philips Roeselare = HQ
Production period : year- and week code (4 digits)

1.6. Ordering information

Order the capacitors by quoting the 12-digit catalogue number as shown in Tables 1 to 4.

1.7. Certified test records (CTR)

Not required.

Metallized polycarbonate film capacitors

2222 344**2. INSPECTION REQUIREMENTS**

Note 1 : Sub-clause numbers of tests and performance requirements refer to the Sectional Specification, IEC-publication 384-6 (at present Document 40 secretariat 463) and Section One of this specification.

Note 2 : Inspection levels and AQL's are selected from IEC-Publication 410 : Sampling Plans and Procedures for Inspection by attributes.

Note 3 : In this table :

- p = periodicity (in months)
- n = sample size
- c = acceptance criterion (permitted number of defectives)
- D = destructive
- ND = non-destructive
- IL = inspection level) IEC 410
- AQL = acceptable quality level)

Note 4 : For this capacitor, considered as a solid construction, it is permitted to reduce the periodicity of the vibration and shock test from 6 months to 36 months.
In the event of a single defective occurring in subgroup Clb at this reduced rate of testing, then the vibration and shock tests shall revert to a 6 monthly periodicity until three successive 6-monthly tests shall have produced no defectives.

Metallized polycarbonate film capacitors

2222 344

Clause number and Test (see Note 1)	D or ND	Conditions of Test (see Note 1)	IL (see Note 2)	AQL	Performance requirements (see Note 1)
<u>Group A Inspection</u> (lot-by-lot)					
<u>Sub-group A1</u>	ND		I	2,5%	
4.1 Visual examination					- No mechanical failures - Legible marking and as specified in GENERAL DATA of this specification.
4.2 Dimensions		Gauging			- As specified in Tables 1 to 4 of this specification.
<u>Sub-group A2</u>	ND		II	1%	
4.2.1 Voltage proof (Test A)		at $1,6 \times U_{Rdc}$ for 1 s.			- No breakdown or flashover
4.2.2 Capacitance		at 1kHz			- Within specified tolerance
4.2.3 Tangent of loss angle		at 10kHz			- As in GENERAL DATA of this specification.
4.2.4 Insulation resistance (Test A)		at 100V for $U_R=100V$ 250V 400V at 500V for $U_R=630V$			- As in GENERAL DATA of this specification.

Metallized polycarbonate film capacitors

2222 344

Sub-clause number and Test (see Note 1)	D or ND	Conditions of test (see Note 1)	Sample size + criterion of accepta- bility (see Note 3)			Performance requirements
			p	n	c	
<u>Group C inspection</u> (periodic)						
<u>Sub-group ClA</u>	D		6	9	1	
Part of sample of Sub-group Cl						
4.1 Dimensions (detail)						As specified in Tables 1 to 4 of this specification
4.3.1 Initial measurements		Capacitance Tangent of loss angle for C < 470nF at 100kHz C > 470nF at 10kHz				
4.3 Robustness of terminations		Tensile and bending				No visible damage
4.4 Resistance to soldering heat		Methode : 1A Solder bath : 260°C Duration : 10 s				
4.14 Component solvent resistance		Mixture 1,1,2- trichlorotrifluoro- ethane and 2 - propanol (isopro- pylalcohol) Temperature : 48,6° to 50,5°C(boiling) Method : 2 Immersion time : 5 ± 0,5 min. Recovery time : min. 1h max. 2h.				
4.4.2 Final measurements		Visual examination Capacitance Tangent of loss angle				No visible damage Legible marking $\frac{\Delta C}{C} < 1\%$ of the va- lue measured initially Increase of tan delta < 0,005 for C < 470nF < 0,003 for C > 470nF compared to values measured in 4.3.1

Metallized polycarbonate film capacitors

2222 344

Sub-clause number and Test (see Note 1)	D or ND	Conditions of test (see Note 1)	Sample size + criterion of accepta- bility (see Note 3)			Performance requirements
			p	n	c	
<u>Sub-group C1B</u> Other part of sample of Sub-group C1	D		6	18	1	
4.6.1 Initial measurements		Capacitance Tangent of loss angle for C < 470nF at 100kHz C > 470nF at 10kHz				
4.6 Rapid change of temperature		θ A=lower cat. temp. θ B=upper cat. temp. 5 cycles Duration t = 30min. Visual examination				No visible damage
4.7 Vibration (see Note 4)		Method of mounting see GENERAL DATA of this specification. Procedure B4. Frequency range : 10Hz to 55Hz. Amplitude 0,75mm or acceleration 98m/s ² (whichever is the less severe) Total duration 6h				
4.7.2 Final inspection		Visual examination				No visible damage
4.9 Shock (see Note 4)		Method of mounting see GENERAL DATA of this specification Pulse shape : half sine Accelerat.: 490m/s ² Duration of pulse : 11ms				
4.9.3 Final measurements		Visual examination Capacitance				No visible damage $\Delta \frac{C}{C} \leq 2,5\%$ of the C value measu- red in 4.6.1

Metallized polycarbonate film capacitors

2222 344

Sub-clause number and Test (see Note 1)	D or ND	Conditions of test (see Note 1)	Sample size + criterion of accepta- bility (see Note 3)			Performance requirements
			p	n	c	
		Tangent of loss angle				Increase of tan delta <0,005 for $C_R < 470nF$ <0,003 for $C_R > 470nF$ compared to values measured in 4.6.1 As in GENERAL DATA of this specifi- cation.
		Insulation resistance				
<u>Sub-group C1</u> Combined sample of spe- cimens of Sub-groups C1A and C1B	D		6	27	2	
4.10 Climatic sequence						
4.10.2 Dry heat		Temperature : upper category temperature Duration : 16h				
4.10.3 Damp heat cyclic, Test Db, first cycle						
4.10.4 Cold		Temperature : lower category temper. Duration : 2h				
4.10.6 Damp heat cyclic, Test Db remaining cycles						
4.10.6.2 Final measurements		Visual examination Capacitance Tangent of loss angle Insulation resistance				No visible damage Legible marking $\frac{\Delta C}{C} < 3\%$ of value measured in 4.4.2. or 4.9.3. Increase of tan delta <0,007 for $C < 470nF$ <0,005 for $C > 470nF$ compared to values measured in 4.3.1 or 4.6.1 >50% of values in GENERAL DATA of this specification

Metallized polycarbonate film capacitors

2222 344

Sub-clause number and Test (see Note 1)	D or ND	Conditions of test (see Note 1)	Sample size + criterion of accepta- bility (see Note 3)			Performance requirements
			p	n	c	
<u>Sub-group C2</u>	D		6	15	1	
4.11 Damp heat steady state						
4.11.1 Initial measurements		Capacitance Tangent of loss angle for C < 470nF at 100kHz C > 470nF at 10kHz				
4.11.3 Final measurements		Visual examination Capacitance Tangent of loss angle Insulation resistance				No visible damage Legible marking $\Delta \frac{C}{C} < 3\%$ of the C value measu- red in 4.11.1 Increase of tan δ < 0,007 for C < 470nF < 0,005 for C > 470nF compared to values measured in 4.11.1 > 50% of values in GENERAL DATA of this specification
<u>Sub-group C3</u>	D		3	21	1	
4.12 Endurance		Duration : 2000 h 1,25U _{Rdc} at 85°C 1,25U _C at 100°C				
4.12.1 Initial measurements		Capacitance Tangent of loss angle for C < 470nF at 100kHz C > 470nF at 10kHz				

Metallized polycarbonate film capacitors

2222 344

Sub-clause number and Test (see Note 1)	D or ND	Conditions of test (see Note 1)	Sample size + criterion of accepta- bility (see Note 3)			Performance requirements
			p	n	c	
4.12.5 Final measurements		Visual examination Capacitance Tangent of loss angle Insulation resistance				No visible damage Legible marking $\Delta \frac{C}{C} < 3\%$ of value measured in 4.12.1 Increase of tan delta <0,005 for C <470nF <0,003 for C >470nF compared to values measured in 4.12.1 >50% of values in GENERAL DATA of this specification
<u>Sub-group C4</u>	D		3	9	1	
4.13 Charge and discharge		10 000cycles (50c/s) charge to U_R half sinus wave Duration : 5 ms discharge R = $\frac{U_R}{C \cdot 2,5 \left(\frac{dU}{dt} \right) R}$ with a min. of 2,2Ω				
4.13.1 Initial measurements		Capacitance Tangent of loss angle for C < 470nF at 100kHz C > 470nF at 10kHz				
4.13.3 Final measurements		Capacitance Tangent of loss angle Insulation resistance				$\Delta \frac{C}{C} < 2\%$ of value measured in 4.13.1 Increase of tan delta <0,005 for C <470nF <0,003 for C >470nF > 50% of values in GENERAL DATA of this specification

Metallized polycarbonate film capacitors

2222 344

Additional tests	D or ND	Conditions of test	Sample size + criterion of accepta- bility			Performance requirements
			p	n	c	
<u>Sub-group ADD1</u> A.1 Solderability Solvent resistance of the marking	D	Without ageing Method : 1 Non-activated colo- phany flux 501 Solder bath 235°C Dwell time : 2 s. Mixture 1,1,2- trichlorotrifluoro- ethane and 2 - propanol (isopro- pylalcohol) Temperature : 48,6° to 50,5°C(boiling) Method 1 Rubbing material : cotton wool Immersion time 5 ± 0,5 min.	3	35	1	Good tinning as evidenced by free flowing of the solder with wet- ting of the ter- minations (>95%)
<u>Sub-group ADD2</u> A.2 Heat storage A.2.1 Initial measurements A.2.2 Final measurements	D	Duration : 2000h Temperature : upper category temperature Capacitance Tangent of loss angle for C < 470nF at 100kHz C > 470nF at 10kHz Capacitance Tangent of loss angle Insulation resistance	3	12	1	Δ C < 3% of value C measured in A.2.1 Increase of tan delta <0,005 for C <470nF <0,003 for C >470nF compared to values measured in A.2.1 As in GENERAL DATA of this specifi- cation.

Metallized polycarbonate film capacitors

2222 344

Additional tests	D or ND	Conditions of test	Sample size + criterion of accepta- bility			Performance requirements
			p	n	c	
<hr/>						
<u>Sub-group ADD3</u>			3	9	1	
A.3 Endurance for capacitors with max. a.c. voltage $\geq 200V$ r.m.s.		Duration : 1000h Temperature : $85^{\circ}C$ Voltage: $1,25 \times \text{max. a.c. voltage (r.m.s. value)}$, 50Hz				
A.3.1 Initial measurements		Capacitance Tangent of loss angle for $C < 470nF$ at 100kHz $C > 470nF$ at 10kHz				
A.3.2 Final measurements		Capacitance Tangent of loss angle Insulation resistance				$\Delta \frac{C}{C} < 3\%$ of value measured in A.3.1 Increase of $\tan \delta$ $< 0,005$ for $C < 470nF$ $< 0,003$ for $C > 470nF$ compared to values measured in A.3.1 As in GENERAL DATA of this specification.

Metallized polycarbonate film capacitors

2222 344

Additional tests	D or ND	Conditions of test	Sample size + criterion of accepta- bility			Performance requirements
			p	n	c	
<hr/>						
<u>Sub-group ADD4</u>			3	9	1	
A.4 Detergent resistance		Density 20g/l Dishwasher detergent Temperature 70°C during 3 min. Followed by rinsing in clear water for 1 min. Recovery time > 2h				
A.4.1 Initial measurements		Capacitance Tangent of loss angle for C < 470nF at 100kHz C > 470nF at 10kHz				
A.4.2 Final measurements		Capacitance Tangent of loss angle Insulation resistance				$\Delta \frac{C}{C} \leq 1\%$ of value C measured in A.4.1 Increase of tan delta < 0,005 for C < 470nF < 0,003 for C > 470nF compared to values measured in A.4.1 > 50% of values in GENERAL DATA of this specification.
<hr/>						
<u>Sub-group ADD5</u>	D		6	15	1	
A.5 Resistance to solde- ring heat with pre- heating.		Capacitors mounted on a 1,6mm board with nonplated holes Body temp. : 80°C Bath temp. : 260°C Dwell time : 5s				
A.5.1 Initial measurements		Capacitance Tangent of loss angle for C < 470nF at 100kHz C > 470nF at 10kHz				

Metallized polycarbonate film capacitors

2222 344

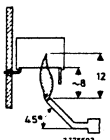
Additional tests	D or ND	Conditions of test	Sample size + criterion of acceptability			Performance requirements
			p	n	c	
A.5.2 Final measurements		Capacitance Tangent of loss angle				$\Delta \frac{C}{C} < 1\%$ of value measured in A.5.1 Increase of tan delta >0,005 for $C < 470nF$ <0,003 for $C > 470nF$ compared to values measured in A.5.1
<u>Sub-group ADD6</u> A.6.1 Needle flame test IEC 40 (secr.)580 Class C	D	Bore of gas jet : ∅ 0,5mm Fuel : butane Test duration for actual volume V (mm ³). <250 = 5s. 250 <V<500 = 10s. 500 <V<1750 = 20s. V > 1750 = 30s. One flame applica- tion. 	6	15	1	After removing the test flame from the capacitor, the ca- pacitor must not continue to burn for more than 30s., no burning parti- cles must drop from the sample.
<u>Sub-group ADD7</u> A.7 Climatic test on taped type		10 days at 40 + 2°C R.H. 90 to 95% Recovery time : 24h	3	15	0	Change in position of lead hole over 20 pitch distances < 0,5mm. Angle of component < 4°. Pull out and tearing forces > 50% of values in GENERAL DATA of this specification

Maintenance

Philips Components

Data sheet	
status	Product specification
date of issue	May 1990

2222 341**Metallized polyethyleneterephthalate
film capacitors**

MKT Axial moulded type

° Supplied loose in box

QUICK REFERENCE DATA

Capacitance range (E12-series)	0,0082 to 6,8 μ F
Capacitance tolerance	<u>+20%</u> , <u>+10%</u> , <u>+5%</u>
Rated voltage U _{Rdc}	100V, 250V, 400V
Climatic category	55/100/56
Rated temperature	85°C
Tangent of loss angle at 10kHz	100 x 10 ⁻⁴
Related specification	IEC 384-2
Performance grade	Grade 2 (general purpose)

Metallized polyethyleneterephthalate film capacitors

2222 341

SURVEY OF STYLES

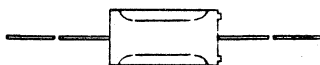

Style : 2222 341
See Tables 1 to 3

CONSTRUCTION

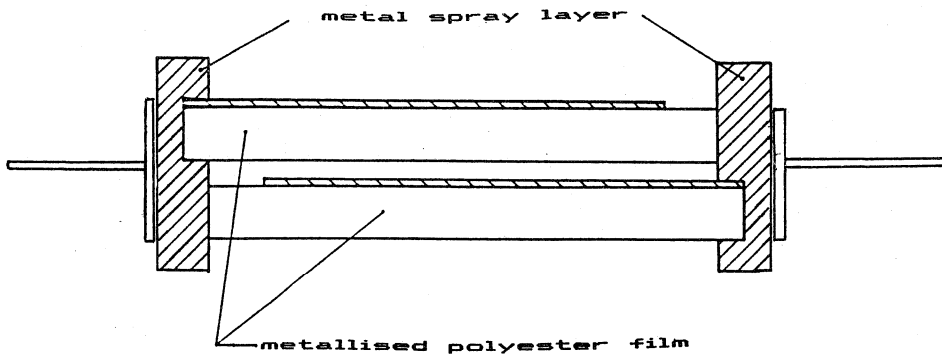

Metallized polyethyleneterephthalate film capacitors

2222 341

APPLICATION

In electronic circuits for blocking and coupling, bypass and energy reservoir applications.

DESCRIPTION

The capacitors consist of a low-inductive wound cell of metallized polyethyleneterephthalate (PETP) film. The cell is moulded in yellow flame retardant polypropylene. The axial leads are of solder-coated wire. One end of the capacitor is provided with two stand-off ridges to allow removal of solder flux etc., when cleaning the printed-wiring board.

1. GENERAL DATA

1.1. Mounting

Normal use

The capacitors are designed for horizontal or vertical mounting on printed-wiring boards and for point to point wiring.

Specified method of mounting to withstand vibration and shock

In order to withstand vibration and shock tests, it must be ensured that the capacitor body is in good contact with the printed-wiring board. For case sizes up to and including a mass of 6g. the capacitor shall be mechanically fixed by the leads.

With larger case sizes the capacitor shall be mounted in the same way and the body shall be clamped.

Metallized polyethyleneterephthalate film capacitors

2222 341

1.2.1 Dimensions in mm

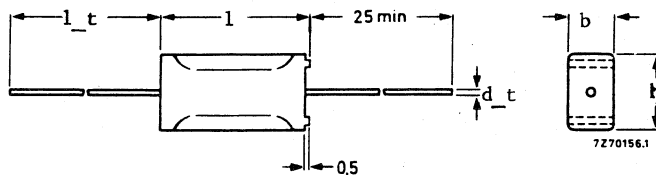

Fig. 1

Table 1 $U_{Rdc} = 100V$; max. a.c. voltage = 63V

capacitance μF	b_{max}	h_{max}	l_{max}	d_t	l_t min	mass g	catalogue number 2222 341		
							C-tol $\pm 20\%$	C-tol $\pm 10\%$	C-tol $\pm 5\%$
0,082							26823	27823	25823
0,10							26104	27104	25104
0,12	5,1	8,8	14,6			1,0	26124	27124	25124
0,15							26154	27154	25154
0,18							26184	27184	25184
0,22							26224	27224	25224
0,27	5,7	9,5	14,6			1,1	26274	27274	25274
0,33				0,8	40		26334	27334	25334
0,39							26394	27394	25394
0,47	6,6	10,4	18,1			1,7	26474	27474	25474
0,56							26564	27564	25564
0,68	7,8	11,6	23,5			2,5	26684	27684	25684
0,82							26824	27824	25824
1,0	9,2	12,9	23,5			3,2	26105	27105	25105
1,2							26125	27125	25125
1,5	10,8	14,5	23,5			4,0	26155	27155	25155
1,8							26185	27185	25185
2,2	10,7	14,6	31			5,5	26225	27225	25225
2,7							26275	27275	25275
3,3	12,5	19,5	31	1	50	8,0	26335	27335	25335
3,9							26395	27395	25395
4,7							26475	27475	25475
5,6	15,4	22,1	31			10,5	26565	27565	25565
6,8							26685	27685	25685

Metallized polyethyleneterephthalate film capacitors

2222 341

Table 2 $U_{Rdc} = 250V$; max. a.c. voltage = 160V, Fig. 1

capacitance μF	b_max	h_max	l_max	d_t	l_t min	mass g	catalogue number 2222 341		
							C-tol + 20%	C-tol + 10%	C-tol + 5%
0,039							88393	89393	87393
0,047							88473	89473	87473
0,056	5,1	8,8	14,6			1,0	88563	89563	87563
0,068							88683	89683	87683
0,082	5,7	9,5	14,6			1,1	88823	89823	87823
0,10							88104	89104	87104
0,12							88124	89124	87124
0,15							88154	89154	87154
0,18	6,6	10,4	18,1	0,8	40	1,7	88184	89184	87184
0,22							88224	89224	87224
0,27							88274	89274	87274
0,33							88334	89334	87334
0,39	7,8	11,6	23,5			2,5	88394	89394	87394
0,47							88474	89474	87474
0,56	9,2	12,9	23,5			3,2	88564	89564	87564
0,68							88684	89684	87684
0,82							88824	89824	87824
1,0	10,7	14,6	31			5,5	88105	89105	87105
1,2							88125	89125	87125
1,5				1	50		88155	89155	87155
1,8	12,5	19,5	31			8,0	88185	89185	87185
2,2							88225	89225	87225

Metallized polyethyleneterephthalate film capacitors

2222 341

Table 3 $U_{Rdc} = 400V$; max. a.c. voltage = 220V, Fig. 1

capacitance pF, μF	b_max	h_max	l_max	d_t	l_t min	mass g	catalogue number 2222 341		
							C-tol + 20%	C-tol + 10%	C-tol + 5%
8200pF							54822	55822	53822
0,010 μF							54103	55103	53103
0,012							54123	55123	53123
0,015	5,1	8,8	14,6			1,0	54153	55153	53153
0,018							54183	55183	53183
0,022							54223	55223	53223
0,027							54273	55273	53273
0,033							54333	55333	53333
0,039	7	10,6	14,6	0,8	40	1,4	54393	55393	53393
0,047							54473	55473	53473
0,056	6,6	10,4	18,1			1,7	54563	55563	53563
0,068							54683	55683	53683
0,082	7,9	11,5	18,1			2,0	54823	55823	53823
0,10							54104	55104	53104
0,12	7,8	11,6	23,5			2,5	54124	55124	53124
0,15							54154	55154	53154
0,18	9,2	12,9	23,5			3,2	54184	55184	53184
0,22							54224	55224	53224
0,27	10,8	14,5	23,5			4,0	54274	55274	53274
0,33							54334	55334	53334
0,39	10,7	14,6	31			5,5	54394	55394	53394
0,47							54474	55474	53474
0,56	12,5	19,5	31	1	50	8,0	54564	55564	53564
0,68							54684	55684	53684
0,82	15,4	22,1	31			10,5	54824	55824	53824
1,0							54105	55105	53105

Metallized polyethyleneterephthalate film capacitors**2222 341****1.2.2 Packing**

The capacitors are supplied loose in box, the quantity per box is given in the table below.

<u>h</u> max mm	Number of cap. per box	
	SPQ	PQ
<u>≤</u> 11,6	250	1000
<u>></u> 11,6	200	1000

Metallized polyethyleneterephthalate film capacitors

2222 341

1.3 Ratings and characteristics

Unless otherwise specified all electrical values apply to an ambient free air temperature of 23 \pm 1°C, an atmospheric pressure of 86 to 106 kPa and a relative humidity of 50 \pm 2%.

1.3.1 Capacitance

Capacitance range at 1 kHz see Tables 1 to 3

Capacitance tolerance see Tables 1 to 3

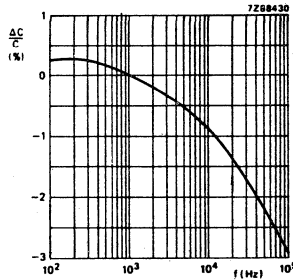

Fig. 2 : Capacitance as a function of frequency; typical curve.

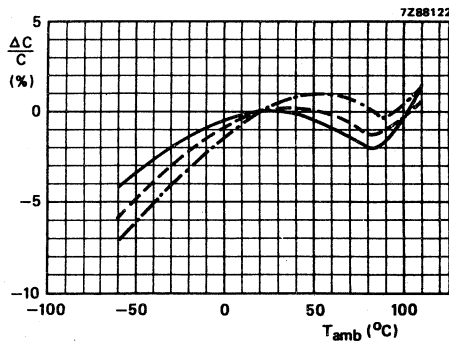

Fig. 3 : Capacitance as a function of ambient free air temperature; typical curves.

- for all capacitance values, measured at 1kHz, 1V.
- for capacitance values \leq 1 μ F, measured at 10kHz, 1V.
- · - · - · for capacitance values \leq 0,1 μ F, measured at 100kHz, 0,3V.

Metallized polyethyleneterephthalate film capacitors

2222 341**1.3.2 Voltage**

Rated voltage U_{Rdc}	see Tables 1 to 3
Category voltage U_C	$0,8 \times U_{Rdc}$
Test voltage between terminations	$1,6 \times U_{Rdc}$
between interconnected terminations and case(foil method)	$2 \times U_{Rdc}$; min. 200V
Max. a.c. voltage (r.m.s. value), at 50 to 60Hz	see Tables 1 to 3

1.3.3 Climatic category
----- 55/100/56**1.3.4 Rated temperature**
----- 85°C**1.3.5 Storage temperature range**
----- Temperature -25°C to +40°C
RH max. 80% without condensation

Metallized polyethyleneterephthalate film capacitors

2222 341

1.3.6 Tangent of loss angle

Capacitance	Tangent of loss angle		
	1kHz	10kHz	100kHz
C < 0,1μF	$< 75 \times 10^{-4}$	$< 130 \times 10^{-4}$	$< 250 \times 10^{-4}$
0,1μF < C < 1μF	$< 75 \times 10^{-4}$	$< 130 \times 10^{-4}$	
C > 1μF	$< 75 \times 10^{-4}$	$< 150 \times 10^{-4}$	

Fig. 4 : Tan delta as a function of frequency, typical curve

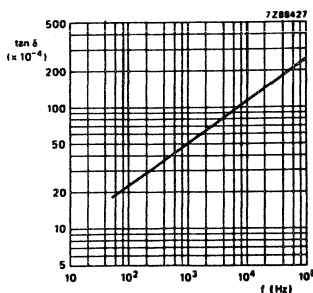

1.3.7 Maximum pulse load $\frac{dU}{dt} R$

Rated voltage V	Maximum pulse load (V/μs)			
	l=14,5mm	l=18mm	l=23,5mm	l=31mm
100	24	10	6	3,5
250	35	14	9	5
400	55	22	14	8

The maximum pulse load values in the table are valid for pulse voltages equal to the rated voltage.

For lower pulse voltages the given values may be multiplied by U_R applied voltage.

Metallized polyethyleneterephthalate film capacitors

2222 341

1.3.8 Insulation resistance at $T_{amb. 20^{\circ}C}$

The insulation resistance is measured after a voltage of $100V \pm 15V$ has been applied for $1 \text{ min.} \pm 5 \text{ s}$.

R between terminations, for $C \leq 0,33\mu F$
 100V versions $> 15\ 000\ M\Omega$
 250V and 400V versions $> 30\ 000\ M\Omega$

RC between terminations, for $C > 0,33\mu F$
 100V versions $> 5\ 000\ \text{s}$
 250V and 400V versions $> 10\ 000\ \text{s}$

R between interconnected terminations and case $> 30\ 000\ M\Omega$
 (foil method)

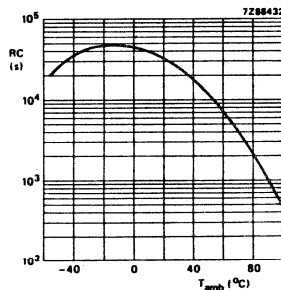
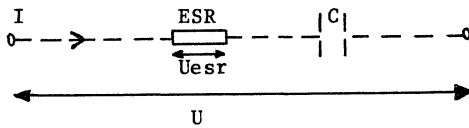

Fig. 5 : RC-product as a function of ambient free air temperature; typical curve

1.3.9 Maximum dissipation

The power dissipated by a capacitor is a function of the voltage U_{esr} across or the current I through the series resistance ESR and is expressed by:

$$P = \frac{U_{esr}^2}{ESR} \quad (1) \quad \text{or } P = ESR \cdot I^2 \quad (2)$$



$$U_{esr}^2 = \frac{ESR^2}{ESR^2 + 1/\omega^2 C^2} \cdot U^2 \quad (3a)$$

As for film capacitors $\tan_{\delta} = \omega \cdot C \cdot ESR \ll 0.1$, the formula (3a) can be simplified to

$$U_{esr}^2 = ESR^2 \cdot \omega^2 \cdot C^2 \cdot U^2 \quad (3b)$$

or with $ESR = \tan_{\delta} / \omega C$, we become:

$$P = \omega \cdot C \cdot \tan_{\delta} \cdot U^2 \quad (4) \quad \text{or } P = \frac{\tan_{\delta}}{\omega \cdot C} I^2 \quad (5)$$

For the \tan_{δ} we can take the value found from fig.4, C is in farad and $\omega = 2 \cdot \pi \cdot f$.

U or I are assumed to be known.

The maximum permissible power dissipation (P_{max}), which depends on the dimensions of the capacitor and on the ambient free air temperature can be found from fig.6.

In applications where sine waves occur, we have to take for U the RMS-voltage or for I the RMS-current of the sine wave.

In applications where periodic signals occur, the signal has to be expressed in Fourier-terms:

$$U = U_0 + \sum_{k=1}^{\infty} \sin(k\omega t + \varphi_k) \quad (6)$$

Metallized polyethyleneterephthalate film capacitors

2222 341

$$I = \sum_{k=1}^{\infty} I_k \sin(k\omega t + \varphi_k) \quad (7)$$

with U_0 the D.C.voltage, U_k and I_k the voltage resp. current of the k-th harmonic.

We become for the dissipated power :

$$\text{with (6)} \quad P = \sum_{k=1}^{\infty} k \cdot \omega \cdot C \cdot \tan_{\Delta} \cdot U_k^2 \quad (8)$$

$$\text{with (7)} \quad P = \sum_{k=1}^{\infty} \frac{\tan_{\Delta} \cdot I_k^2}{k \cdot \omega \cdot C \cdot 2} \quad (9)$$

and $\tan_{\Delta k}$ is the \tan_{Δ} at the k-th harmonic.

Curve	dimensions (mm)		
	b_max	h_max	l_max
1	5,1	8,8	14,6
2	5,7	9,5	14,6
3	7	10,6	14,6
4	6,6	10,4	18,1
5	7,9	11,5	18,1
6	7,8	11,6	23,5
7	9,2	12,9	23,5
8	10,8	14,5	23,5
9	10,7	14,6	31
10	12,5	19,5	31
11	15,4	22,1	31

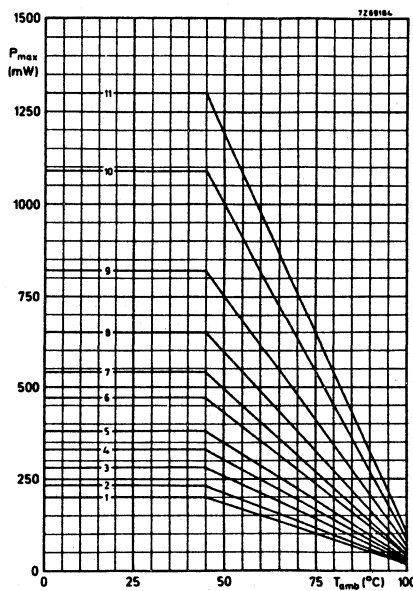

Fig. 6 Maximum permissible power dissipation as a function of ambient free air temperature.

1.3.10 Application note

To select this capacitor for a certain application you have to check 6 conditions.

1. The peak voltage (U_p) shall not be greater than the rated d.c. voltage.
2. The peak to peak voltage (U_{pp}) shall not be greater than $2\sqrt{2}$ times the rated a.c. voltage to avoid the ionisation inception level.
3. The peak current (I_p) shall not exceed the maximum peak current, defined as maximum voltage pulse slope (dU/dt) multiplied by the capacitance.

$$I_p \text{ max} = C \left(\frac{dU}{dt} \right) \text{ max.}$$

Or the voltage pulse slope shall not exceed the rated voltage pulse slope.
If the pulse voltage is lower than the rated voltage, the values of tabel 1.3 may be multiplied by U_{Rdc} and divided by applied voltage.

4. The dissipated power shall not be greater than the maximum permissible power dissipation stated in 1.3.9.
5. The free air ambient temperature for the capacitor is not exceeding the category temperature.
6. Since all metallised film capacitors have always intrinsically active flammability risk, it is recommended to use these capacitors only in these circuits where in case of failure of the capacitor the power can be limited to less than 5 VA to the capacitor.

Metallized polyethyleneterephthalate film capacitors

2222 341

Example of using Fig. 4 and 6.

A capacitor of 1,0 μ F should be used at a sine voltage of 130 Vrms, a frequency of 1 kHz and an ambient free air temperature of 50°C.

Is it possible to use a 1 μ F/250V ?

Checking the 6 conditions

1. The peak voltage $U_p = 183 (\sqrt{2} \times 130)$ is lower than 250 Vdc
2. The peak to peak voltage 367 U_{pp} is lower than 160 Vac $2\sqrt{2} = 452 U_{pp}$
3. Because of the sinewave, we have not to check the pulse conditions.
4. The \tan_{δ} is 0.005 (from Fig. 4), so that the power to be dissipated is :

$$\begin{aligned} P &= w.C.\tan_{\delta} . U^2 \\ &= 2.\pi.10^3 . 1,0 . 10^{-6} . 0,005 . 130^2 W \\ &= 530 \text{ mW} \end{aligned}$$

This is less than 595 mW at 50°C for its dimensions 10,7 x 14,6 x 31, seen in fig. 6.

5. The free air temperature is 50°C, and lower than 100°C.
6. In case of failure, the power is switched off.

Metallized polyethyleneterephthalate film capacitors

2222 341

1.4 Related documents

Generic specification	IEC 384-1
Sectional specification	IEC 384-2

1.5 Marking

The capacitors are marked by impression on one side with the following information :

- Capacitance in pF or μ F
- Capacitance tolerance (e.g. 10)
- Rated voltage (e.g. 400)
- Manufacturer's type designation (341)
- Code for dielectric material (MKT)
- Production date code acc. to IEC-62, clause 5

Example : |0.27/10/400
 |341 MKT ..

The capacitors are also marked by impression on the other side with the following information :

- Manufacturer's name (PHILIPS)
- Code for factory of origin (HQ)

Example : PHILIPS
 HQ

Metallized polyethyleneterephthalate film capacitors

2222 341

The package containing the capacitors is marked as follows

Data on label of SPQ and PQ
(example)

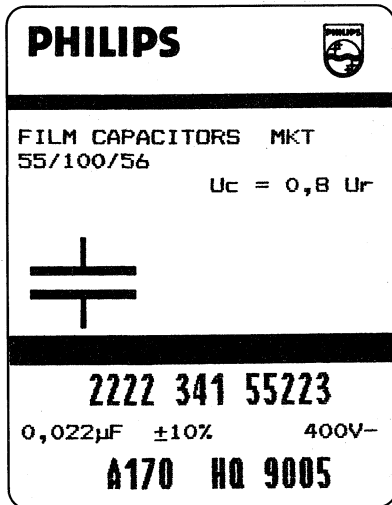

Block A : Philips word mark and emblem

Block B : Line 1 : Film capacitors and material code
Line 2 : Climatic category number and category voltage
Line 3 : Country standard

Capacitor symbol

Block C : Line 1 : Product code (12 NC)

Line 2 : Cap. value in
< 10 K in pF followed by pF
> 10 K in µF followed by µF
Tolerance followed by + and %
Voltage followed by V⁻
Line 3 : Number of capacitors
Preference-origin code : A
Country of origin : Belgium=170
Responsible production centre :
Philips Roeselare : HQ
Production period : year- and week code (4digits)

1.6. Ordering information

Order the capacitors by quoting the 12-digit catalogue number as shown in Tables 1 to 3.

1.7. Certified test records (CTR)

Not required.

Philips Components

Data sheet	
status	Product specification
date of issue	May 1990

2222 344**Metallized polyethyleneterephthalate film capacitors**

MKT Radial potted type

- ° 10 to 27,5mm terminal pitch
- ° Supplied loose in box

QUICK REFERENCE DATA

Capacitance range (E12-series)	0,01 to 10 μ F
Capacitance tolerance	<u>+20%</u> , <u>+10%</u> , <u>+5%</u>
Rated voltage U _{Rdc}	63V, 100V, 250V, 400V
Climatic category	55/100/56
Rated temperature	85°C
Tangent of loss angle at 10kHz	100 x 10 ⁻⁴
Related specification	IEC 384-2
Performance grade	Grade 1 (long life)
Qualified according to	CECC 30401-039 2 nd edition

**Metallized polyethyleneterephthalate
film capacitors**

2222 344

SURVEY OF STYLES



Style : 2222 344
Terminal pitch : 10mm, 15mm
Tables 1 to 4

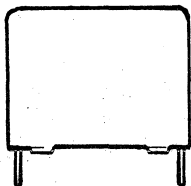

Style : 2222 344
Terminal pitch : 22,5mm, 27,5mm
Tables 1 to 4

CONSTRUCTION

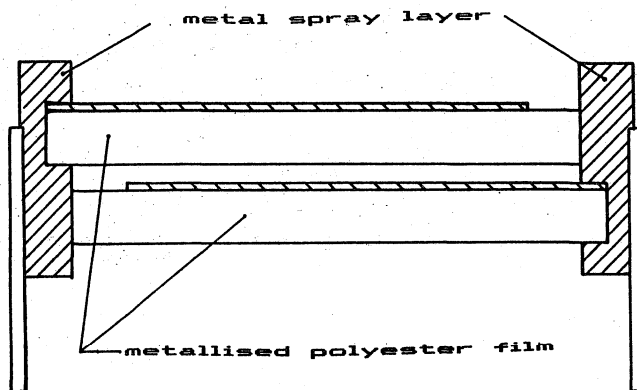

Metallized polyethyleneterephthalate film capacitors

2222 344

APPLICATION

In electronic circuits for blocking and coupling, bypass and energy reservoir applications. Their defined dimensions make them extremely suitable for circuits with high packaging density.

DESCRIPTION

The capacitors consist of a low-inductive wound cell of metallized polyethyleneterephthalate (PETP) film. The cell is potted with epoxy resin in a blue flame retardent polypropylene case. The radial leads are of solder-coated wire. The capacitors can withstand solvents and rinsing liquids without damage. They have small stand-off pips to allow removal of solder flux etc., during cleaning of the printed-wiring board.

1. GENERAL DATA

1.1. Mounting

Normal use

The capacitors are designed for printed wiring applications.

Specific method of mounting to withstand vibration and shock

In order to withstand vibration and shock tests, it must be insured that the stand-off pips are in good contact with the printed-wiring board. For case sizes up to and including a mass of 6 g the capacitors shall be mechanically fixed by the leads.

With larger case sizes the capacitors shall be mounted in the same way and the body shall be clamped.

Metallized polyethyleneterephthalate film capacitors

2222 344

1.2.1 Dimensions in mm

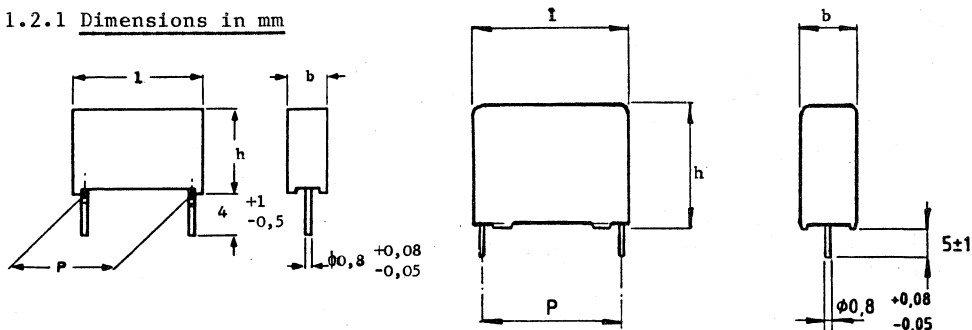
Table 1 $U_{Rdc} = 63V$; max. a.c. voltage = 40V, Fig. 1 and 2

capacitance *	b_max	h_max	l_max	P	mass g	catalogue number 2222 344		
						C-tol + 20%	C-tol + 10%	C-tol + 5%
0,18	4,5	10	13	$10 \pm 0,3$	0,7	14184	15184	13184
0,22	4,5	10	13			14224	15224	13224
0,27	5	11	13		0,85	14274	15274	13274
0,33	5	11	13			14334	15334	13334
0,39	5	11	13			14394	15394	13394
0,47	5	11	13			14474	15474	13474
0,56	5	11	17,5	$15 \pm 0,3$	1,05	14564	15564	13564
0,68	5	11	17,5		1,4	14684	15684	13684
0,82	6	12	17,5		1,8	14824	15824	13824
1,0	6	12	17,5			14105	15105	13105
1,2	7	13	17,5			14125	15125	13125
1,5	7	13	17,5			14155	15155	13155
1,8	6	15,5	26	$22,5 \pm 0,3$	2,75	14185	15185	13185
2,2	7	16,5	26		4,3	14225	15225	13225
2,7	7	16,5	26		5,1	14275	15275	13275
3,3	8,5	18	26			14335	15335	13335
3,9	8,5	18	26			14395	15395	13395
4,7	10	19,5	26			14475	15475	13475
5,6	11	21	31	$27,5 \pm 0,3$	7,4	14565	15565	13565
6,8	11	21	31			14685	15685	13685
8,2	13	23	31		10,2	14825	15825	13825
10	13	23	31			14106	15106	13106

+ 5% available on request

*Not yet CECC 30401-039 approved

**Metallized polyethyleneterephthalate
film capacitors**

2222 344

Table 2 $U_{Rdc} = 100V$; max. a.c. voltage = 63V, Fig. 1 and 2

capacitance *	b_max	h_max	l_max	P	mass g	catalogue number 2222 344		
						C-tol + 20%	C-tol + 10%	C-tol + 5%
μF								
0,082	4,5	10	13			24823	25823	23823
0,10	4,5	10	13			24104	25104	23104
0,12	4,5	10	13		0,7	24124	25124	23124
0,15	4,5	10	13	$10 \pm 0,3$		24154	25154	23154
0,18	4,5	10	13			24184	25184	23184
0,22	4,5	10	13			24224	25224	23224
0,27	5	11	17,5		1,05	24274	25274	23274
0,33	5	11	17,5			24334	25334	23334
0,39	5	11	17,5			24394	25394	23394
0,47	5	11	17,5			24474	25474	23474
0,56	6	12	17,5	$15 \pm 0,3$	1,4	24564	25564	23564
0,68	6	12	17,5			24684	25684	23684
0,82	7	13	17,5		1,8	24824	25824	23824
1,0	7	13	17,5			24105	25105	23105
1,2	7	16,5	26		2,75	24125	25125	23125
1,5	7	16,5	26			24155	25155	23155
1,8	8,5	18	26	$22,5 \pm 0,3$	4,3	24185	25185	23185
2,2	8,5	18	26			24225	25225	23225
2,7	8,5	18	26		5,1	24275	25275	23275
3,3	10	19,5	26			24335	25335	23335
3,9	11	21	31		7,4	24395	25395	23395
4,7	11	21	31			24475	25475	23475
5,6	13	23	31	$27,5 \pm 0,3$	10,2	24565	25565	23565
6,8	13	23	31			24685	25685	23685
8,2	15	25	31		12,8	24825	25825	23825
10	15	25	31			24106	25106	23106

*Capacitance range according to CECC 30401-023/039 (2nd edition)

Metallized polyethyleneterephthalate film capacitors

2222 344

Table 3 $U_{Rdc} = 250V$; max. a.c. voltage = 160V, Fig. 1 and 2

capacitance * μF	b_max	h_max	l_max	P	mass g	catalogue number 2222 344		
						C-tol + 20%	C-tol + 10%	C-tol + 5%
0,039	4,5	10	13			40393	41393	42393
0,047	4,5	10	13			40473	41473	42473
0,056	4,5	10	13	$10 \pm 0,3$	0,7	40563	41563	42563
0,068	4,5	10	13			40683	41683	42683
0,082**	5	11	17,5			40823	41823	42823
0,10 **	5	11	17,5			40104	41104	42104
0,12	5	11	17,5		1,05	40124	41124	42124
0,15	5	11	17,5			40154	41154	42154
0,18	6	12	17,5		1,4	40184	41184	42184
0,22	6	12	17,5			40224	41224	42224
0,27	7	13	17,5	$15 \pm 0,3$	1,8	40274	41274	42274
0,33	7	13	17,5			40334	41334	42334
0,39	6	15,5	26			40394	41394	42394
0,47	6	15,5	26		2,75	40474	41474	42474
0,56	6	15,5	26			40564	41564	42564
0,68	7	16,5	26			40684	41684	42684
0,82	8,5	18	26	$22,5 \pm 0,3$	4,4	40824	41824	42824
1,0	8,5	18	26			40105	41105	42105
1,2	11	21	31			40125	41125	42125
1,5	11	21	31			40155	41155	42155
1,8	11	21	31	$27,5 \pm 0,3$	7,4	40185	41185	42185
2,2	11	21	31			40225	41225	42225

*Capacitance range according to CECC 30401-023/039 (2nd edition)

**Not CECC 30401-023 approved

Metallized polyethyleneterephthalate film capacitors

2222 344

Table 4 $U_{Rdc} = 400V$; max. a.c. voltage = 220V, Fig. 1 and 2

capacitance *	b_max	h_max	l_max	P	mass g	catalogue number 2222 344			
						C-tol + 20%	C-tol + 10%	C-tol + 5%	
μF									
0,010	4,5	10	13	$10 \pm 0,3$	0,7	54103	55103	53103	
0,012	4,5	10	13			54123	55123	53123	
0,015	4,5	10	13			54153	55153	53153	
0,018	4,5	10	13			54183	55183	53183	
0,022	4,5	10	13			54223	55223	53223	
0,027	4,5	10	13			54273	55273	53273	
0,033	4,5	10	13			54333	55333	53333	
0,039	5	11	17,5	$15 \pm 0,3$	1,05	54393	55393	53393	
0,047	5	11	17,5			54473	55473	53473	
0,056	5	11	17,5			54563	55563	53563	
0,068	5	11	17,5			54683	55683	53683	
0,082	6	12	17,5			1,4	54823	55823	53823
0,10	6	12	17,5			54104	55104	53104	
0,12	7	13	17,5			1,8	54124	55124	53124
0,15	7	13	17,5			54154	55154	53154	
0,18	6	15,5	26	$22,5 \pm 0,3$	2,75	54184	55184	53184	
0,22	6	15,5	26			54224	55224	53224	
0,27	7	16,5	26			3,5	54274	55274	53274
0,33	8,5	18	26			54334	55334	53334	
0,39	8,5	18	26			5,1	54394	55394	53394
0,47	10	19,5	26			54474	55474	53474	
0,56	11	21	31			7,4	54564	55564	53564
0,68	11	21	31	$27,5 \pm 0,3$	10,2	54684	55684	53684	
0,82	13	23	31			54824	55824	53824	
1,0	13	23	31			54105	55105	53105	

*Capacitance range according to CECC 30401-023/039 (2nd edition)

**Metallized polyethyleneterephthalate
film capacitors**

2222 344

1.2.2 Packing

The capacitors are supplied loose in box, the quantity per box is given in the table below.

Table 5 : Number of capacitors per box.

l_max mm	Number of capacitors per box	
	SPQ	PQ
13	1000	4000
17,5	1000	4000
26	200	1000
31	100	500

Metallized polyethyleneterephthalate film capacitors

2222 344

1.3. Ratings and characteristics

Unless otherwise specified all electrical values apply to an ambient free air temperature of $23 \pm 1^\circ\text{C}$, an atmospheric pressure of 86 to 106 kPa and a relative humidity of $50 \pm 2\%$.

1.3.1 Capacitance

Rated capacitance range at 1 kHz see Tables 1 to 4

Tolerance on rated capacitance see Tables 1 to 4

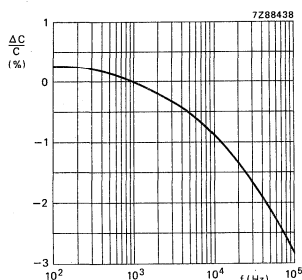

Fig. 3: Capacitance as a function of frequency; typical curve.

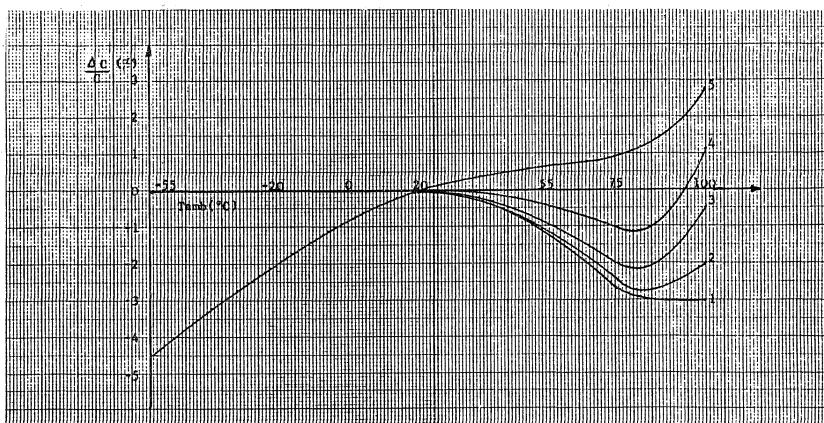

Fig. 4: Capacitance as a function of ambient free air temperature measured at 1 kHz, typical curves.

1. 63 V series
2. 100V series
3. 250V series
4. 400V series

**Metallized polyethyleneterephthalate
film capacitors**

2222 344**1.3.2 Voltage**
-----Rated voltage U_{Rdc}

See Tables 1 to 4

Category voltage U_C $0,8 \times U_{Rdc}$ Test voltage
between terminations
between interconnected terminations
and case(foil method) $1,6 \times U_{Rdc}$ $2 \times U_{Rdc}$; min. 200VMax. a.c. voltage (r.m.s. value)
at 50 to 60 Hz

See Tables 1 to 4

1.3.3 Climatic category

55/100/56

1.3.4 Rated temperature

85°C

1.3.5 Storage temperature range
-----Temperature -55°C to +100°C
RH max. 80% without
condensation

**Metallized polyethyleneterephthalate
film capacitors**

2222 344

1.3.6. Tangent of loss angle

capacitance	tangent of loss angle		
	1kHz	10kHz	100kHz
$C < 0,1\mu\text{F}$ $0,1\mu\text{F} < C < 1\mu\text{F}$ $C < 1\mu\text{F}$	$< 75 \times 10^{-4}$ $< 75 \times 10^{-4}$ $< 75 \times 10^{-4}$	$< 130 \times 10^{-4}$ $< 130 \times 10^{-4}$ $< 150 \times 10^{-4}$	$< 250 \times 10^{-4}$

Fig. 5 : Tan delta as a function of frequency, typical curve

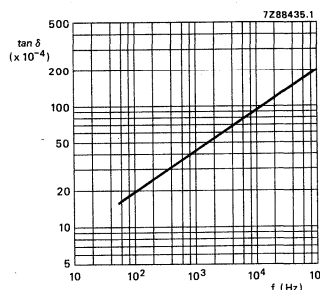

1.3.7. Rated voltage pulse slope $\frac{dU}{dt}$ R

rated voltage V	maximum pulse load (V/ μs)			
	l= 13mm	l=17,5mm	l=26mm	l=31mm
63	16			
100	34	14	5	4
250	50	16	7	6
400	80	34	14	12

The maximum pulse load values in the table are valid for pulse voltages equal to the rated voltage.

For lower pulse voltages the given values may be multiplied by $U_R/\text{applied voltage}$.

Note :

If the pulse load requirement is satisfied, a check must be made to ascertain that the maximum dissipation is not exceeded.

Metallized polyethyleneterephthalate film capacitors

2222 344

1.3.8 Insulation resistance at $T_{amb} 20^{\circ}C$

The insulation resistance is measured after a voltage has been applied for 1 min. \pm 5 s., the voltage being 10 \pm 1V for the 63V version and 100V \pm 15V for the 100V, 250V and 400V versions.

R between terminations, for $C \leq 0,33\mu F$	
63V and 100V versions	> 15 000 $M\Omega$
250V and 400V versions	> 30 000 $M\Omega$

RC between terminations, for $C > 0,33\mu F$	
63V and 100V versions	> 5 000 s
250V and 400V versions	> 10 000 s

R between interconnected terminations and case (foil method)	> 30 000 $M\Omega$
---	--------------------

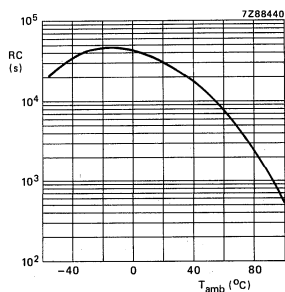

Fig. 6 : RC-product as a function of ambient free air temperature; typical curve

Metallized polyethyleneterephthalate film capacitors

2222 344

1.3.9 Maximum dissipation

The power dissipated by a capacitor is a function of the voltage U_{esr} across or the current I through the series resistance ESR and is expressed by:

$$P = \frac{U_{\text{esr}}^2}{\text{ESR}} \quad (1) \quad \text{or } P = \text{ESR} \cdot I^2 \quad (2)$$

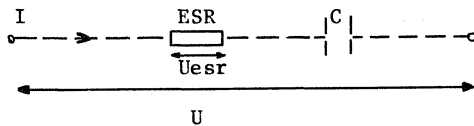

$$U_{\text{esr}}^2 = \frac{\text{ESR}^2}{\text{ESR}^2 + 1/w^2 C^2} \cdot U^2 \quad (3a)$$

As for film capacitors $\tan_{\text{delta}} = w \cdot C \cdot \text{ESR} \ll 0.01$, the formula (3a) can be simplified to

$$U_{\text{esr}}^2 = \text{ESR}^2 \cdot w^2 \cdot C^2 \cdot U^2 \quad (3b)$$

or with $\text{ESR} = \tan_{\text{delta}}/wC$, we become:

$$P = w \cdot C \cdot \tan_{\text{delta}} \cdot U^2 \quad (4) \quad \text{or } P = \frac{\tan_{\text{delta}}}{w \cdot C} I^2 \quad (5)$$

For the \tan_{delta} we can take the value found from fig.5, C is in farad and $w = 2 \cdot \pi \cdot f$.

U or I are assumed to be known.

The maximum permissible power dissipation (P_{max}), which depends on the dimensions of the capacitor and on the ambient free air temperature can be found from fig.7.

In applications where sine waves occur, we have to take for U the RMS-voltage or for I the RMS-current of the sine wave.

In applications where periodic signals occur, the signal has to be expressed in Fourier-terms:

$$U = U_0 + \sum_{k=1}^{\infty} \frac{1}{k+1} \sin(kwt + \varphi_k) \quad (6)$$

Metallized polyethyleneterephthalate film capacitors

2222 344

$$I = \sum_{k=1}^{\infty} I_k \sin(k\omega t + \phi_k) \quad (7)$$

with U_0 the D.C.voltage, U_k and I_k the voltage resp. of the k -th harmonic.

We become for the dissipated power :

$$\text{with (6)} \quad P = \sum_{k=1}^{\infty} k \cdot \omega \cdot C \cdot \tan_{\Delta} a_k \frac{U_k^2}{2} \quad (8)$$

$$\text{with (7)} \quad P = \sum_{k=1}^{\infty} \frac{\tan_{\Delta} a_k \cdot I_k^2}{k \cdot \omega \cdot C \cdot 2} \quad (9)$$

and $\tan_{\Delta} a_k$ is the \tan_{Δ} at the k -th harmonic.

curve	dimensions (mm)		
	b_max	h_max	l_max
8	4,5	10	13
10	5	11	13
12	5	11	17,5
13	6	12	17,5
14	7	13	17,5
16	6	15,5	26
17	7,5	16,5	26
18	8,5	17,5	26
19	9,5	19	26
20	11	20	31
21	13	22,5	31
22	15	25	31
23	18	28	31

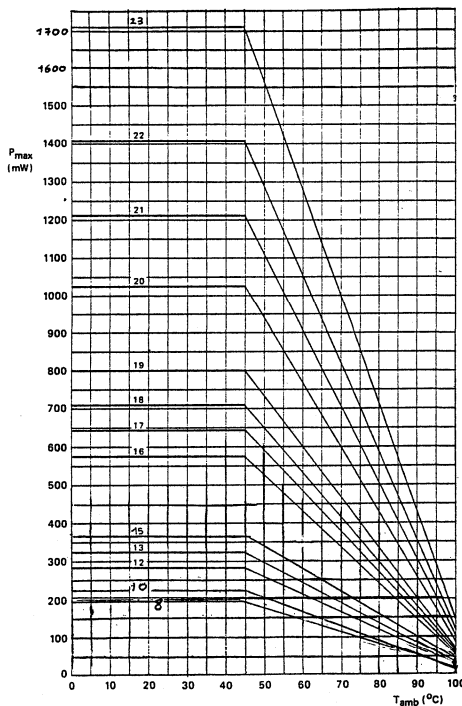

Fig. 7 : Maximum dissipation as a function of ambient free air temperature.

**Metallized polyethyleneterephthalate
film capacitors**

2222 344

1.3.10 Application note

To select this capacitor for a certain application you have to check 6 conditions :

1. The peak voltage (U_p) shall not be greater than the rated d.c. voltage.
2. The peak to peak voltage (U_{pp}) shall not be greater than $2\sqrt{2}$ times the rated a.c. voltage to avoid the ionisation inception level.
3. The peak current (I_p) shall not exceed the maximum peak current, defined as maximum voltage pulse slope (dU/dt) multiplied by the capacitance.

$$I_p \text{ max} = C \left(\frac{dU}{dt} \right) \text{ max.}$$

Or the voltage pulse slope shall not exceed the rated voltage pulse slope.

If the pulse voltage is lower than the rated voltage, the values of tabel 1.3.7 may be multiplied by U_{Rdc} and divided by applied voltage.

4. The dissipated power shall not be greater than the maximum permissible power dissipation stated in 1.3.9.
5. The free air ambient temperature for the capacitor is not exceeding the category temperature.
6. In applications where voltages higher than 50V are applied, it is recommended that the power in the capacitor be limited to 2,5 VA in case of a capacitor failure.

Metallized polyethyleneterephthalate film capacitors

2222 344

Example of using Fig. 5 and 7.

A capacitor of 1,0 μ F should be used at a sine voltage of 100Vrms, a frequency of 1kHz and an ambient free air temperature of 50°C.

The \tan_{δ} is 0.0045 (from Fig. 5), so that the power to be dissipated is :

$$\begin{aligned} P &= w.C.\tan_{\delta} \cdot U^2 \\ &= 2\pi \cdot 10^3 \times 1,0 \cdot 10^{-6} \times 0.0045 \cdot (100)^2 \\ &= 280 \text{ mW} \end{aligned}$$

For a rated voltage of 100 Vac a capacitor of the 250V range is required at least.

Is a 1 μ F/250V satisfactory ?

Checking the 6 conditions

1. The peak voltage $U_p = 140 (\sqrt{2} \times 100)$ is lower than 250Vdc.
2. The peak to peak voltage $280U_{pp}$ is lower than 160Vac $2\sqrt{2} = 452 U_{pp}$
3. Because of the sinewave, we have not to check the pulse conditions.
4. The dissipated power is : 280 mW
This is less than 700 mW at 50°C for its dimensions 8,5 x 17,5 x 26 seen in Fig. 7.
5. The free air ambient temperature is 50°C, and lower than 100°C.
6. In case of failure, the power is switched off.

Metallized polyethyleneterephthalate film capacitors

2222 344

The package containing the capacitors is marked as follows

Data on label SPQ and PQ
(example)

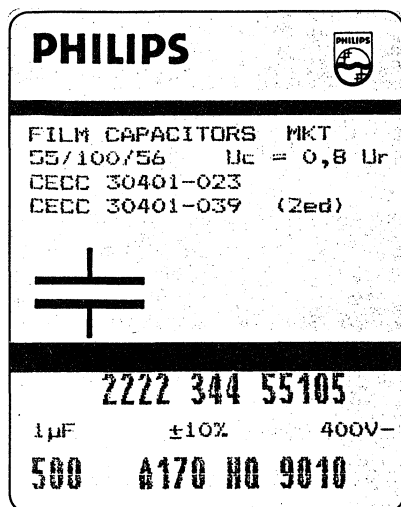

Block A : Philips word mark and emblem

Block B : Line 1 : Film capacitors and material code
Line 2 : Climatic group number and category voltage
Line 3 : Country standard

Capacitor symbol

Block C : Line 1 : Product code (12 NC)

Line 2 : Capacitance value
<10 K in pF followed by pF
>10K in μ F followed by μ F
Tolerance followed by \pm and %
Voltage followed by V-

Line 3 : Number of capacitors
Preference-origin code : A
Country of origin : Belgium=170
Responsible production centre :
Philips Roeselare = HQ
Production period : year- and week code (4 digits)

1.6. Ordering information

Order the capacitors by quoting the 12-digit catalogue number as shown in Tables 1 to 4.

1.7. Certified test records (CTR)

Required for the types with Qualification Approval according to CECC 30401-039.

Philips Components

Data sheet	
status	Products specification
date of issue	May 1990

2222 357 5....

Polypropylene film/foil capacitors

KP Radial potted type

- ° 27,5mm terminal pitch
- ° Supplied loose in box

QUICK REFERENCE DATA

Capacitance range (E12-series)	0,22 to 0,82 μ F
Capacitance tolerance	<u>±</u> 10%, <u>±</u> 5%
Rated voltage U _{Rdc}	250V
Climatic category	55/085/56
Rated temperature	85°C
Related specification	IEC 384-13
Stability class	Class 3

Polypropylene film/foil capacitors

2222 357 5....

SURVEY OF STYLE

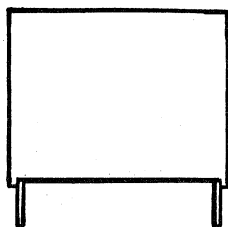

Style : 2222 357 5....
Terminal pitch : 27,5mm
See Table 1

CONSTRUCTION

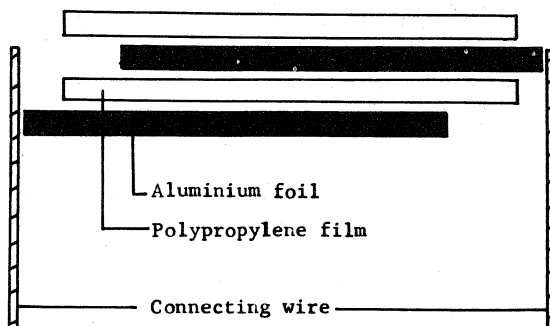

Polypropylene film/foil capacitors2222 357 5....

APPLICATION

These capacitors are intended for applications where high currents and steep pulses occur. They are mainly used for deflection circuits in television receivers, to operate at high peak currents at line frequency. When requiring advice, please send oscillograms of current and voltage waveforms.

DESCRIPTION

The capacitors consist of an impregnated, low-inductive wound cell of aluminium foil and polypropylene film.

The cell is potted with epoxy resin in a yellow flame-retardent polypropylene case. The radial leads are solder-coated wire.

The capacitors can withstand solvents and rinsing liquids without damage. They are provided with small stand-off pips to allow removal of solder flux etc., when cleaning the printed-wiring board.

1. GENERAL DATA**1.1. Mounting****Normal use**

The capacitors are designed for printed wiring applications.

Specific method of mounting to withstand vibration and shock

In order to withstand vibration and shock tests, it must be insured that the stand-off pips are in good contact with the printing-wiring board.

For case sizes up to and including a mass of 6 g the capacitors shall be mechanically fixed by the leads.

With larger case sizes the capacitors shall be mounted in the same way and body shall be clamped.

Polypropylene film/foil capacitors

2222 357 5....

1.2.1 Dimensions in mm

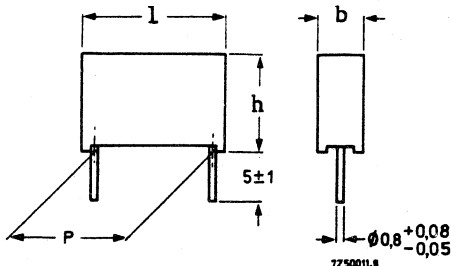

Fig. 1

Table 1 $U_{Rdc} = 250V$; max. a.c. voltage = 160V, Fig. 1

capacitance μF	b_max	h_max	l_max	P	mass g	catalogue number 2222 357....	
						C-tol $+ 10\%$	C-tol $+ 5\%$
0,22	10	20	34	$27,5 \pm 0,4$	8,5	51224	52224
0,27	10	20	34		8,5	51274	52274
0,33	12	22	34		11	51334	52334
0,39	12	22	34		11	51394	52394
0,47	15	25	34		16	51474	52474
0,56	15	25	34		16	51564	52564
0,68	15	25	34		16	51684	52684
0,82	18	28	34		22	51824	52824

1.2.2 Packing

The capacitors are supplied loose in box, the quantity per box is given in the table below.

l_max mm	Number of capacitors per box	
	SPQ	PQ
34	100	500

Polypropylene film/foil capacitors

2222 357 5....

1.3. Ratings and characteristics

Unless otherwise specified all electrical values apply to an ambient free air temperature of $23 \pm 1^\circ\text{C}$, an atmospheric pressure of 86 to 106 kPa and a relative humidity of $50 \pm 2\%$.

1.3.1 Capacitance

Capacitance range at 1 kHz	see Table 1
Capacitance tolerance	see Table 1
Frequency dependance between 100 Hz and 100 kHz	negligible

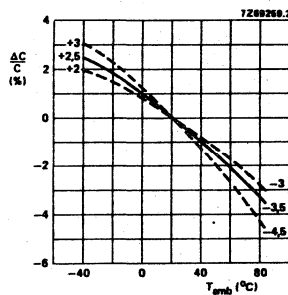

Fig. 2 : Capacitance as a function of ambient free air temperature; typical curve

Polypropylene film/foil capacitors

2222 357 5....

1.3.2 Voltage

Rated voltage U_{Rdc}	see Table 1
Test voltage between terminations	$2 \times U_{Rdc}$
between interconnected terminations and case (foil method)	1000V (d.c.)
max. a.c. voltage (r.m.s. value) at 50 to 60 Hz	see Table 1

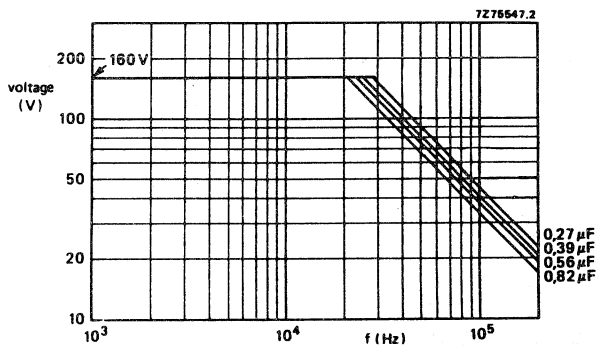

Fig. 3 Maximum a.c. voltage (r.m.s. value) as a function of frequency at $T_{amb} \leq 45^{\circ}C$

1.3.3 Climatic category	55/085/56
1.3.4 Rated temperature	85°C
1.3.5 Storage temperature range	Temperature $-25^{\circ}C$ to $+40^{\circ}C$ RH max. 80% without condensation

Polypropylene film/foil capacitors

2222 357 5....

1.3.6 Tangent of loss angle at 100 kHz

	$C < 0,33\mu\text{F}$	$< 15 \times 10^{-4}$
$0,33\mu\text{F} < C < 0,47\mu\text{F}$	$< 0,47\mu\text{F}$	$< 20 \times 10^{-4}$
$C > 0,47\mu\text{F}$		$< 25 \times 10^{-4}$

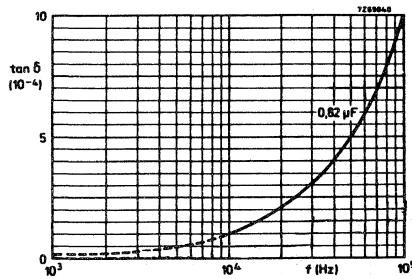

Fig. 4 : tan_delta as a function of frequency; typical curve.

1.3.7 Maximum voltage pulse slope ($\frac{dU}{dt}$)R

Limited by network conditions

1.3.8 Insulation resistance at $T_{amb} 20^{\circ}\text{C}$

The insulation resistance is measured after a voltage of 100V
+ 15V has been applied for 1 min. + 5 s.

RC between terminations > 5 000 s.

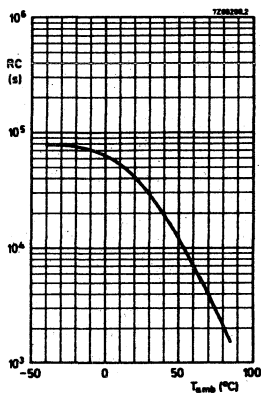

Fig. 5 : RC-product as a function of ambient free air temperature,
typical curve.

Polypropylene film/foil capacitors

2222 357 5....

1.3.9 Maximum dissipation

The power dissipated by a capacitor is a function of the voltage U_{esr} across or the current I through the series resistance ESR and is expressed by:

$$P = \frac{U_{esr}^2}{ESR} \quad (1) \quad \text{or } P = ESR \cdot I^2 \quad (2)$$

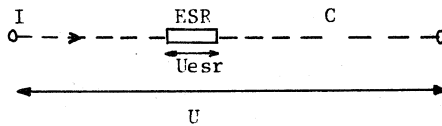

$$U_{esr}^2 = \frac{ESR^2}{ESR^2 + 1/w^2 C^2} \cdot U^2 \quad (3a)$$

As for film capacitors $\tan_{\Delta} = w.C.ESR \ll 0.1$, the formula (3a) can be simplified to

$$U_{esr}^2 = ESR^2 \cdot w^2 \cdot C^2 \cdot U^2 \quad (3b)$$

or with $ESR = \tan_{\Delta}/wC$, we become:

$$P = w.C.\tan_{\Delta}.U^2 \quad (4) \quad \text{or } P = \frac{\tan_{\Delta}}{w.C} I^2 \quad (5)$$

For the \tan_{Δ} we can take the value found from fig.4, C is in farad and $w = 2.\pi.f$.

U or I are assumed to be known.

The maximum permissible power dissipation (P_{max}), which depends on the dimensions of the capacitor and on the ambient free air temperature can be found from fig.6.

In applications where sine waves occur, we have to take for U the RMS-voltage or for I the RMS-current of the sine wave.

In applications where periodic signals occur, the signal has to be expressed in Fourier-terms:

$$U = U_0 + \sum_{k=1}^{\infty} \sin(kwt + \varphi_k) \quad (6)$$

Polypropylene film/foil capacitors

2222 357 5....

$$I = \sum_{k=1}^{\infty} I_k \sin(k\omega t + \varphi_k) \quad (7)$$

with U_0 the D.C.voltage, U_k and I_k the voltage resp. current of the k-th harmonic.

We become for the dissipated power :

$$\text{with (6)} \quad P = \sum_{k=1}^{\infty} k \cdot w \cdot c \cdot \tan_{\text{delta}}_k \cdot \frac{U_k^2}{2} \quad (8)$$

$$\text{with (7)} \quad P = \sum_{k=1}^{\infty} \frac{\tan_{\text{delta}}_k \cdot I_k^2}{k \cdot w \cdot C \cdot 2} \quad (9)$$

and \tan_{delta}_k is the \tan_{delta} at the k-th harmonic.

Curve	Dimensions in mm		
	b_max.	h_max.	l_max.
1	10	20	34
2	12	22	34
3	15	25	34
4	18	28	34

Fig. 6 Maximum permissible power dissipation as a function of ambient free air temperature.

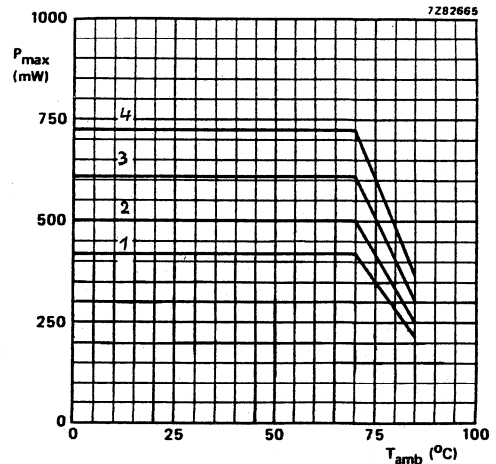

* At $T_{\text{amb}} < 70^\circ\text{C}$ the maximum permissible sinusoidal voltage can be found in Fig. 3.

Polypropylene film/foil capacitors

2222 357 5....

1.3.10 Application note

To select this capacitor for a certain application you have to check 5 conditions :

1. The peak voltage (U_p) shall not be greater than the rated d.c. voltage.
2. The peak to peak voltage (U_{pp}) shall not be greater than $2\sqrt{2}$ times the rated a.c. voltage, to avoid the ionisation inception level.
3. There is no limit for the peak current (I_p) or voltage pulse slope (dU/dt) in the application.
4. The dissipated power shall not be greater than the maximum permissible power dissipation stated in 1.3.9.
5. The free air ambient temperature for the capacitor is not exceeding the category temperature.

Polypropylene film/foil capacitors**2222 357 5....**

Example of using Fig. 4 and 6

A capacitor of 0.22 μ F should be used at a sine voltage of 60 Vrms, a frequency of 10 kHz and an ambient free air temperature of 50°C.

The \tan_{δ} is 0.0001 (from Fig.4), so that the power to be dissipated is :

$$\begin{aligned} P &= w.C.\tan_{\delta} \cdot U^2 \\ &= 2 \cdot 10^4 \cdot 0,22 \cdot 10^{-6} \cdot 0,0001 \cdot 60^2 W \\ &= 5 \text{ mW} \end{aligned}$$

Is it possible to use a 0,22 μ F/250V capacitor ?

Checking the 5 conditions

1. The peak voltage $U_p = 85V = (\sqrt{2} \times 60V)$ is lower than 250Vdc.
2. The peak to peak voltage $170U_{pp}$ is lower than 80Vac $2\sqrt{2} = 226 U_{pp}$
3. The voltage pulse slope : of no consideration.
4. The dissipated power is 5 mW.
This is less than 420 mW, allowed for a capacitor with dimensions 10 x 20 x 34mm as seen in fig. 6.
5. The free air ambient temperature is 50°C, and lower than 85°C.

Polypropylene film/foil capacitors

2222 357 5....

1.4. Related documents

Generic specification	IEC 384-1
Sectional specification	IEC 384-13

1.5. Marking

The capacitors are marked on the top by embossed print with the following information :

- ° Capacitance in μF
- ° Capacitance tolerance (e.g. 5)
- ° Rated voltage (250)
- ° Code for dielectric material (KP)
- ° Manufacturer's type designation (357)
- ° Code for factory of origin (HQ)
- ° Production date code acc. to IEC 62, clause 5

The manufacturer's identification symbol is indicated at the left of this marking.

Example :  0.22/5/250
KP 357 HQ..

Polypropylene film/foil capacitors

2222 357 5....

The package containing the capacitors is marked as follows

Data on label SPQ and PQ
(example)

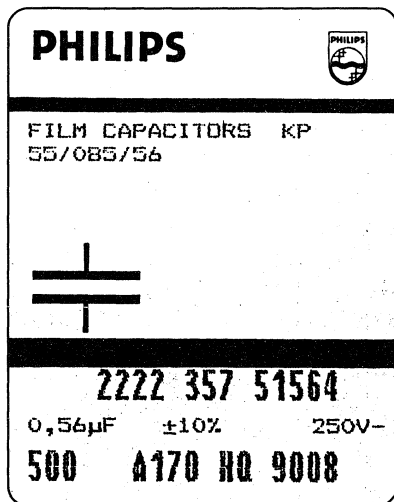

Block A : Philips word mark and emblem

Block B : Line 1 : Film capacitors and
material code
Line 2 : Climatic group number

Capacitor symbol

Block C : Line 1 : Product code (12 NC)

Line 2 : Capacitance value in μF followed
by μF .

Tolerance followed by + and %
Voltage followed by V-

Line 3 : Number of capacitors
Preference-origin code : A
Country of origin : Belgium=170
Responsible production centre :
Philips Roeselare = HQ
Production period : year- and
week code (4 digits)

1.6. Ordering information

Order the capacitors by quoting the 12-digit catalogue number as shown in Table 1.

1.7. Certified test records (CTR)

Not required.

Philips Components

Data sheet	
status	Product specification
date of issue	May 1990

2222 443**Polystyrene film/foil capacitors**

KS Radial potted type

- ° 2,54 to 7,62mm terminal pitch
- ° supplied loose in box

QUICK REFERENCE DATA

Capacitance range (E96-series)	100 to 34000 pF
Capacitance tolerance	$\pm 1\%$
Rated voltage U _{Rdc}	63V
Climatic category	55/070/56 (class 1) 55/085/56 (class 3)
Rated temperature	70°C (class 1) 85°C (class 3)
Related specification	IEC 384-7
Stability class	Class 1 and 3

Polystyrene film/foil capacitors

2222 443

SURVEY OF STYLES

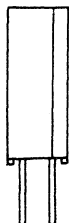

Style 2222 443
Terminal pitch : 5,08 mm
See Tables

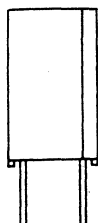

Style 2222 443
Terminal pitch : 7,62 mm
See Tables

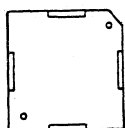
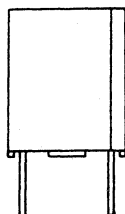

Style 2222 443
Terminal pitch : 10,16 mm
See Tables

CONSTRUCTION

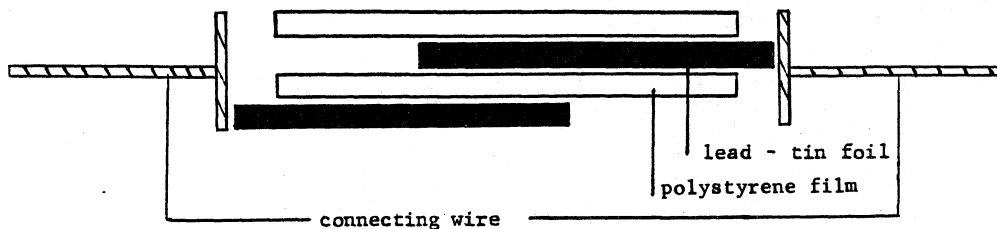

Polystyrene film/foil capacitors

2222 443

APPLICATION

For use in LC filters, particularly in telephony equipment, where high requirements are imposed on precision, stability, humidity, dissipation factor and reliability. The dimensions are such that, in combination with currently available ferrites, a high package density is possible.

DESCRIPTION

The capacitors consist of a low-inductance wound cell of polystyrene film and metal foil. The cell is potted with epoxy resin in a yellow flame retardent polypropylene case, which can withstand solvents and rinsing liquids.

The low thermal conductivity of the radial leads provides optimum soldering conditions. The capacitors are provided with stand-off ridges to give a clearance between the capacitor and the printed-wiring board.

1. GENERAL DATA

1.1. Mounting

Normal use

The capacitors are designed for printed wiring applications.

Polystyrene film/foil capacitors

2222 443

1.2.1 Dimensions in mm

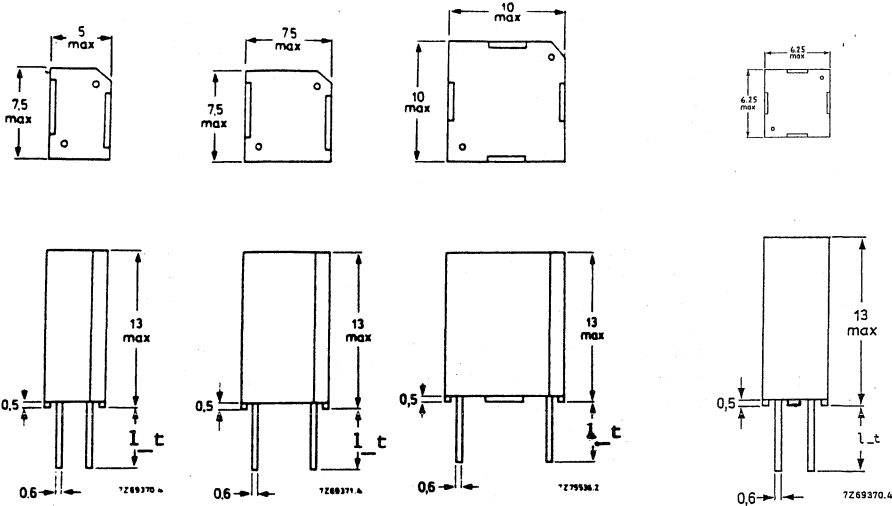

Fig.1 Capacitors of rated capacitance range 100 to 3920pF

Fig.2 Capacitors of rated capacitance range 100 to 15000pF

Fig.3 Capacitors of rated capacitance range 15400 to 34000pF

Fig.4 Capacitors of rated capacitance range 100 to 7500pF

For figures 1,2 and 3 holds : $l_t = 3 \begin{matrix} +0,4 \\ -0 \end{matrix}$ or $5 \begin{matrix} +0 \\ -1 \end{matrix}$

For figure 4 holds : $l_t = 5 \begin{matrix} +0 \\ -1 \end{matrix}$

For all figures holds : $d_t = 0,6 \begin{matrix} +0,06 \\ -0,05 \end{matrix}$

Space requirements on the printed-wiring board for a hole diameter of 1 mm

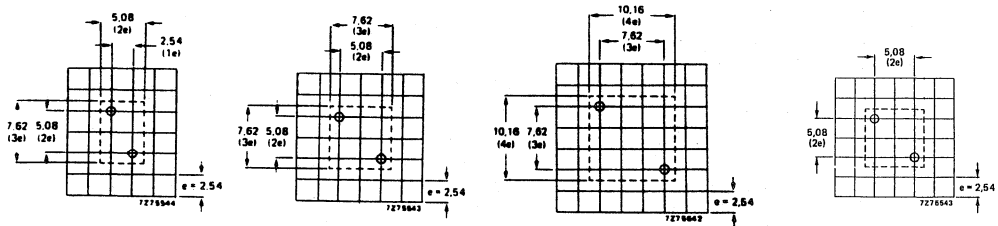

Required space for capacitors according to Fig.1

Required space for capacitors according to Fig.2

Required space for capacitors according to Fig.3

Required space for capacitors according to Fig.4

Polystyrene film/foil capacitors

2222 443

For drawing see sh. 190-4

Table U_Rdc = 63V, max. a.c. voltage = 25V

capacitance (E96-series, C-tol + 1%)*	catalogue number 2222 443		catalogue number 2222 443		catalogue number 2222 443		catalogue number 2222 443
	b_max	l_max	b_max	l_max	b_max	l_max	
pf	mm	mm	mm	mm	mm	mm	mm
	l_t = 3	l_t = 5	l_t = 3	l_t = 5	l_t = 3	l_t = 5	l_t = 5
	6.....	4.....	7.....	8.....	7.....	8.....	3....
174	1741	1741	1741	1741	1741	1741	1741
178	1781	1781	1781	1781	1781	1781	1781
182	1821	1821	1821	1821	1821	1821	1821
187	1871	1871	1871	1871	1871	1871	1871
191	1911	1911	1911	1911	1911	1911	1911
196	1961	1961	1961	1961	1961	1961	1961
200	2001	2001	2001	2001	2001	2001	2001
205	2051	2051	2051	2051	2051	2051	2051
210	2101	2101	2101	2101	2101	2101	2101
215	2151	2151	2151	2151	2151	2151	2151
221	2211	2211	2211	2211	2211	2211	2211
226	2261	2261	2261	2261	2261	2261	2261
232	2321	2321	2321	2321	2321	2321	2321
237	2371	2371	2371	2371	2371	2371	2371
243	2431	2431	2431	2431	2431	2431	2431
249	2491	2491	2491	2491	2491	2491	2491
255	2551	2551	2551	2551	2551	2551	2551
261	2611	2611	2611	2611	2611	2611	2611
267	2671	2671	2671	2671	2671	2671	2671
274	2741	2741	2741	2741	2741	2741	2741
280	2801	2801	2801	2801	2801	2801	2801
287	2871	2871	2871	2871	2871	2871	2871
294	2941	2941	2941	2941	2941	2941	2941

*Besides the values of the E96 series as quoted, intermediate values of the E192 series (with a tolerance + 1%) are available. The specifications of these intermediate values are equal to the specifications of the next higher value of the E96-series.

TYPE SPECIFICATION

Polystyrene film/foil capacitors

2222 443

Table U_Rdc = 63V, max. a.c. voltage = 25V
For drawing see sh. 190-4

capacitance (E96-series, C-tol + 1%)*	catalogue number 2222 443		catalogue number 2222 443		catalogue number 2222 443		TYPE SPECIFICATION
	b_max	l_max	b_max	l_max	b_max	l_max	
µF	mm	mm	mm	mm	mm	mm	
	l_t = 3	l_t = 5	l_t = 3	l_t = 5	l_t = 3	l_t = 5	
	6.....	4.....	7.....	8.....	7.....	8.....	
287	287/1		287/1		287/1		287/1
294	294/1		294/1		294/1		294/1
301	301/1		301/1		301/1		301/1
309	309/1		309/1		309/1		309/1
316	316/1		316/1		316/1		316/1
324	324/1		324/1		324/1		324/1
332	332/1		332/1		332/1		332/1
340	340/1		340/1		340/1		340/1
348	348/1		348/1		348/1		348/1
357	357/1		357/1		357/1		357/1
365	365/1		365/1		365/1		365/1
374	374/1		374/1		374/1		374/1
383	383/1		383/1		383/1		383/1
392	392/1		392/1		392/1		392/1
402	402/1		402/1		402/1		402/1
412	412/1		412/1		412/1		412/1
422	422/1	5	422/1	7,5	422/1	6,25	422/1
432	432/1		432/1		432/1		432/1
442	442/1		442/1		442/1		442/1
453	453/1		453/1		453/1		453/1
464	464/1		464/1		464/1		464/1
475	475/1		475/1		475/1		475/1
487	487/1		487/1		487/1		487/1

* Besides the values of the E96 series as quoted, intermediate values of the E192 series (with a tolerance + 1%) are available. The specifications of these intermediate values are equal to the specifications of the next higher value of the E96-series.

Polystyrene film/foil capacitors

2222 443

For drawing see sh. 190-4

Table U_Rdc = 63V, max. a.c. voltage = 25V

capacitance (E96-series, C-tol + 1%)*	catalogue number 2222 443		catalogue number 2222 443		catalogue number 2222 443		catalogue number 2222 443
	b_max mm	l_max mm	b_max mm	l_max mm	b_max mm	l_max mm	
499		4991		4991		4991	4991
511		5111		5111		5111	5111
523		5231		5231		5231	5231
536		5361		5361		5361	5361
549		5491		5491		5491	5491
562		5621		5621		5621	5621
576		5761		5761		5761	5761
590		5901		5901		5901	5901
604		6041		6041		6041	6041
619		6191		6191		6191	6191
634		6341		6341		6341	6341
649		6491		6491		6491	6491
665		6651		6651		6651	6651
681		6811		6811		6811	6811
698		6981		6981		6981	6981
715		7151		7151		7151	7151
732		7321		7321		7321	7321
750	5	7501	7,5	7501	6,25	7501	7501
768		7681		7681		7681	7681
787		7871		7871		7871	7871
806		8061		8061		8061	8061
825		8251		8251		8251	8251
845		8451		8451		8451	8451

*Besides the values of the E96 series as quoted, intermediate values of the E192 series (with a tolerance + 1%) are available. The specifications of these intermediate values are equal to the specifications of the next higher value of the E96-series.

TYPE SPECIFICATION

Polystyrene film/foil capacitors

2222 443

Table U_{Rdc} = 63V, max. a.c. voltage = 25V
 For drawing see sh. 190-4

capacitance (E96-series, C-tol ± 1%)*	catalogue number 2222 443		catalogue number 2222 443		catalogue number 2222 443		TYPE SPECIFICATION
	b_max	l_max	b_max	l_max	b_max	l_max	
pF	mm	mm	mm	mm	mm	mm	
866		8661		8661		8661	8661
877		8771		8771		8771	8771
909		9091		9091		9091	9091
931		9311		9311		9311	9311
953		9531		9531		9531	9531
976		9761		9761		9761	9761
1000		1002		1002		1002	1002
1020		1022		1022		1022	1022
1050		1052		1052		1052	1052
1070		1072		1072		1072	1072
1100		1102		1102		1102	1102
1130		1132		1132		1132	1132
1150		1152		1152		1152	1152
1180		1182		1182		1182	1182
1210		1212		1212		1212	1212
1240		1242		1242		1242	1242
1270	5	1272	7,5	1272	6,25	1272	1272
1300		1302		1302		1302	1302
1330		1332		1332		1332	1332
1370		1372		1372		1372	1372
1400		1402		1402		1402	1402
1430		1432		1432		1432	1432
1470		1472		1472		1472	1472

* Besides the values of the E96 series as quoted, intermediate values of the E192 series (with a tolerance ± 1%) are available. The specifications of these intermediate values are equal to the specifications of the next higher value of the E96-series.

Polystyrene film/foil capacitors

2222 443

For drawing see sh. 190-4

Table U_Rdc = 63V, max. a.c. voltage = 25V

capacitance (E96-series, C-tol + 1½)* pF	b_max		l_max		catalogue number		b_max		l_max		catalogue number		b_max		l_max		catalogue number		
	mm	mm	mm	mm	1_t = 3	1_t = 5	1_t = 3	1_t = 5	1_t = 3	1_t = 5	1_t = 3	1_t = 5	1_t = 3	1_t = 5	1_t = 3	1_t = 5	1_t = 3	1_t = 5	
1500					6....	4....	7....	8....			1502								1502
1540											1542								1542
1580											1582								1582
1620											1622								1622
1650											1652								1652
1690											1692								1692
1740											1742								1742
1780											1782								1782
1820											1822								1822
1870											1872								1872
1910											1912								1912
1960											1962								1962
2000											2002								2002
2050											2052								2052
2100											2102								2102
2150											2152								2152
2210		5		7,5							2212								2212
2260											2262								2262
2320											2322								2322
2370											2372								2372
2430											2432								2432
2490											2492								2492
2550											2552								2552

*Besides the values of the E96 series as quoted, intermediate values of the E192 series (with a tolerance + 1%) are available. The specifications of these intermediate values are equal to the specifications of the next higher value of the E96-series.

TYPE SPECIFICATION

Polystyrene film/foil capacitors

2222 443

For drawing see sh. 190-4

Table U_{Rdc} = 63V, max. a.c. voltage = 25V

capacitance (E96-series, C-tol + 1%)* pF	b_max		l_max		catalogue number		b_max		l_max		catalogue number	
	mm	mm	mm	mm	1 t = 3 6.....	1 t = 5 4.....	mm	mm	1 t = 3 7.....	1 t = 5 8.....	mm	mm
2610					2612				2612			2612
2670					2672				2672			2672
2740					2742				2742			2742
2800					2802				2802			2802
2870					2872				2872			2872
2940					2942				2942			2942
3010					3012				3012			3012
3090					3092				3092			3092
3160					3162			7,5	3162		6,25	3162
3240	5				3242				3242			3242
3320					3322				3322			3322
3400					3402				3402			3402
3480					3482				3482			3482
3570					3572				3572			3572
3650					3652				3652			3652
3740					3742				3742			3742
3830					3832				3832			3832
3920					3922				3922			3922

* Besides the values of the E96 series as quoted, intermediate values of the E192 series (with a tolerance + 1%) are available. The specifications of these intermediate values are equal to the specifications of the next higher value of the E96-series.

TYPE SPECIFICATION

Polystyrene film/foil capacitors

2222 443

For drawing see sh. 190-4

Table U_{Rdc} = 63V, max. a.c. voltage = 25V

capacitance (E96-series, C-tol + 1%)* pF	b _{max}	l _{max}	catalogue number 2222 443		b _{max}	l _{max}	catalogue number 2222 443
	mm	mm	l _t = 3	l _t = 5	mm	mm	l _t = 5
			6....	4....			3....
4120			4122				4122
4220			4222				4222
4320			4322				4322
4420			4422				4422
4530			4532				4532
4640			4642				4642
4750			4752				4752
4870			4872				4872
4990			4992				4992
5110			5112				5112
5230			5232				5232
5360			5362				5362
5490			5492				5492
5620			5622				5622
5760			5762				5762
5900			5902				5902
6040	7,5	7,5	6042		6,25	6,25	6042
6190			6192				6192
6340			6342				6342
6490			6492				6492
6650			6652				6652
6810			6812				6812
6980			6982				6982
7150			7152				7152
7320			7322				7322
7500			7502				7502
7680			7682				
7870			7872				
8060			8062				
8250			8252				
8450			8452				
8660			8662				
8870			8872				
9090			9092				
9310			9312				
9530			9532				
9760			9762				
10000			1003				

* Besides the values of the E96 series as quoted, intermediate values of the E192 series (with a tolerance $\pm 1\%$) are available. The specifications of these intermediate values are equal to the specifications of the next higher value of the E96-series.

Polystyrene film/foil capacitors

2222 443

For drawing see sh. 190-4

Table U_{Rdc} = 63V, max. a.c. voltage = 25V

capacitance (E96-series, C-tol + 1%)* pF	b _{max} mm	l _{max} mm	catalogue number 2222 443	
			l t = 3 6....	l t = 5 4....
10200				1023
10500				1053
10700				1073
11000				1103
11300				1133
11500				1153
11800				1183
12100				1213
12400				1243
12700	7,5	7,5		1273
13000				1303
13300				1333
13700				1373
14000				1403
14300				1433
14700				1473
15000				1503
15400				1543
15800				1583
16200				1623
16500				1653
16900				1693
17400				1743
17800				1783
18200				1823
18700				1873
19100				1913
20000	10	10		2003
21000				2103
21500				2153
22100				2213
22600				2263
23200				2323
23700				2373
24300				2433
24900				2493
25500				2553
26100				2613
27400				2743

* Besides the values of the E96 series as quoted, intermediate values of the E192 series (with a tolerance + 1%) are available. The specifications of these intermediate values are equal to the specifications of the next higher value of the E96-series.

Polystyrene film/foil capacitors

2222 443

For drawing see sh. 190-4

Table U_{Rdc} = 63V, max. a.c. voltage = 25V

capacitance (E96-series, C-tol + 1%)* pF	b _{max} mm	l _{max} mm	catalogue number	
			2222 443
			l _t = 3 6....	l _t = 5 4....
28000				2803
28700				2873
29400				2943
30100	10	10		3013
30900				3093
31600				3163
32400				3243
33200				3323
34000				3403

* Besides the values of the E96 series as quoted, intermediate values of the E192 series (with a tolerance + 1%) are available. The specifications of these intermediate values are equal to the specifications of the next higher value of the E96-series.

1.2.2 Packing

The capacitors are supplied loose in box, the quantity per box is given in the table below.

Cap. according to Fig.	Number of cap. per box	
	SPQ	PQ
1 or 2	200	1200
3	100	600
4	200	1200

Polystyrene film/foil capacitors

2222 443

1.3.2 Voltage

Rated voltage U_{Rdc}	63 V
Category voltage U_C	U_{Rdc}
Test voltage	
between terminations	$2 \times U_{Rdc}$
between interconnected terminations and case (foil method)	400 V
max. a.c. voltage (r.m.s. value), at 50 to 60 Hz	25V

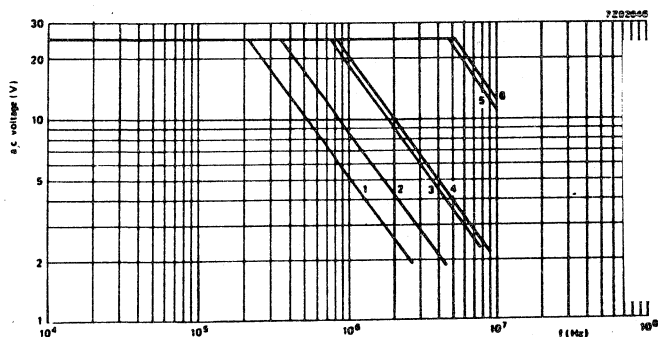

Curve	Cap. value
1	34000 pF
2	15000 pF
3	3920 pF acc. to Fig 1
4	3920 pF acc. to Fig 2
5	100 pF acc. to Fig 1 and 4
6	100 pF acc. to Fig 2

Fig. 5 Maximum a.c. voltage (r.m.s. value)
as a function of frequency at $T_{amb} < 55^{\circ}\text{C}$.

1.3.3 Climatic category

55/070/56 (class 1)
55/085/56 (class 3)

1.3.4 Rated temperature

-55 to +70°C (class 1)
-55 to +85°C (class 3)

1.3.5 Storage temperature range

Temperature -25°C to +40°C
RH max. 80% without condensation

Polystyrene film/foil capacitors

2222 443

1.3.6 Tangent of loss angle

capacitance		tangent of loss angle		
		at 1 kHz	at 100 kHz	at 1 MHz
500 pF	$C < 500$ pF	$< 5 \times 10^{-4}$	-	$< 5 \times 10^{-4}$
1000 pF	$C < 1000$ pF	$< 5 \times 10^{-4}$	-	$< 10 \times 10^{-4}$
10000 pF	$C < 10000$ pF	$< 5 \times 10^{-4}$	$< 10 \times 10^{-4}$	-
15000 pF	$C < 15000$ pF	$< 5 \times 10^{-4}$	$< 15 \times 10^{-4}$	-
20000 pF	$C < 20000$ pF	$< 5 \times 10^{-4}$	$< 25 \times 10^{-4}$	-
	$C < 30000$ pF	$< 5 \times 10^{-4}$	$< 40 \times 10^{-4}$	-
	$C > 30000$ pF	$< 5 \times 10^{-4}$	$< 60 \times 10^{-4}$	-

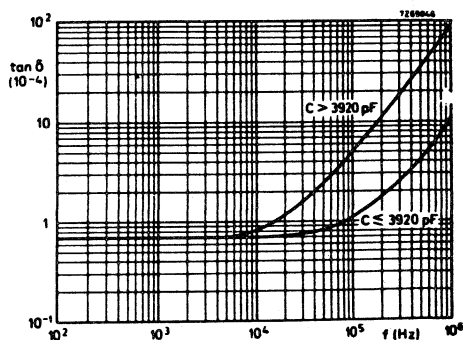

Fig. 6 : tan_delta as a function of frequency; typical curve

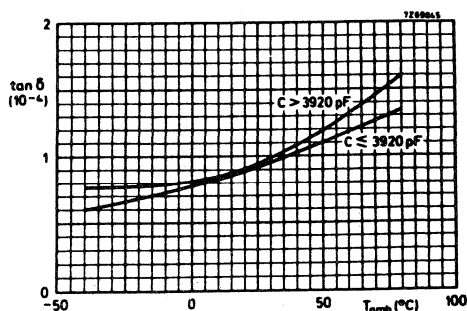

Fig. 7 : Tan_delta as a function of ambient free air temperature; typical curve

Polystyrene film/foil capacitors

2222 443**1.3.7 Insulation resistance at T_{amb} 20°C.**

The insulation resistance is measured after a voltage of 10 ± 1 V has been applied for 1 min. ± 5 s.

R between terminations > 500.000 M Ω

R between interconnected terminations > 500.000 M Ω
and case

Inductance \leq 10nH/cm lead and cap. length

Polystyrene film/foil capacitors

2222 443

1.3.8 Maximum dissipation

The power dissipated by a capacitor is a function of the voltage U_{esr} across or the current I through the series resistance ESR and is expressed by:

$$P = \frac{U_{esr}^2}{ESR} \quad (1) \quad \text{or } P = ESR \cdot I^2 \quad (2)$$

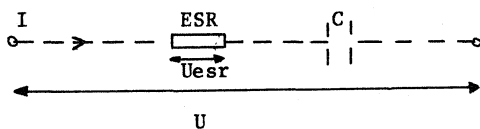

$$U_{esr}^2 = \frac{ESR^2}{ESR^2 + 1/w^2 C^2} \cdot U^2 \quad (3a)$$

As for film capacitors $\tan_{\delta} = w \cdot C \cdot ESR \ll 0,1$, the formula (3a) can be simplified to

$$U_{esr}^2 = ESR^2 \cdot w^2 \cdot C^2 \cdot U^2 \quad (3b)$$

or with $ESR = \tan_{\delta} / wC$, we become:

$$P = w \cdot C \cdot \tan_{\delta} \cdot U^2 \quad (4) \quad \text{or } P = \frac{\tan_{\delta}}{w \cdot C} I^2 \quad (5)$$

For the \tan_{δ} we can take the value found from fig.6, C is in farad and $w = 2 \cdot \pi \cdot f$.

U or I are assumed to be known.

The maximum permissible power dissipation (P_{max}), which depends on the dimensions of the capacitor and on the ambient free air temperature can be found from fig.8.

In applications where sine waves occur, we have to take for U the RMS-voltage or for I the RMS-current of the sine wave.

In applications where periodic signals occur, the signal has to be expressed in Fourier-terms:

$$U = U_0 + \sum_{k=1}^{\infty} \sin(kwt + \varphi_k) \quad (6)$$

Polystyrene film/foil capacitors

2222 443

$$I = \sum_{k=1}^{\infty} I_k \sin(k\omega t + \phi_k) \quad (7)$$

with U_0 the D.C.voltage, U_k and I_k the voltage resp. of the k-th harmonic.

We become for the dissipated power :

with (6)
$$P = \sum_{k=1}^{\infty} k \cdot \omega \cdot C \cdot \tan_{\Delta} \delta_k \cdot \frac{U_k^2}{2} \quad (8)$$

with (7)
$$P = \sum_{k=1}^{\infty} \frac{\tan_{\Delta} \delta_k \cdot I_k^2}{k \cdot \omega \cdot C \cdot 2} \quad (9)$$

and $\tan_{\Delta} \delta_k$ is the $\tan_{\Delta} \delta$ at the k-th harmonic.

curve	dimensions(mm)	
	b_max	l_max
1	5	7,5
1	6,25	6,25
2	7,5	7,5
3	10	10

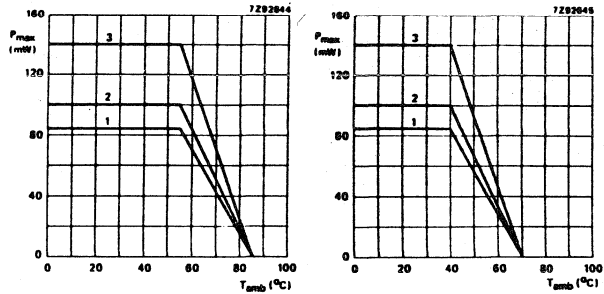

Fig. 8 Maximum permissible power dissipation as a function of ambient free air temperature.

* At $T_{amb} < 55^{\circ}C$ the maximum permissible sinusoidal voltage can be found in fig. 5.

1.3.9 Application note

To select this capacitor for a certain application you have to check 5 conditions :

1. The peak voltage (U_p) shall not be greater than the rated d.c. voltage.
2. The peak to peak voltage (U_{pp}) shall not be greater than $2\sqrt{2}$ times the rated a.c. voltage to avoid the ionisation inception level.
3. The peak current (I_p) shall not exceed the maximum peak current, defined as maximum voltage pulse slope (dU/dt) multiplied by the capacitance.

$$I_p \text{ max} = C \left(\frac{dU}{dt} \right) \text{ max.}$$

Or the voltage pulse slope shall not exceed the rated voltage pulse slope.
If the pulse voltage is lower than the rated voltage, the values of tabel 1.3.4 may be multiplied by U_{Rdc} and divided by applied voltage.

4. The dissipated power shall not be greater than the maximum permissible power dissipation stated in 1.3.8.
5. The free air ambient temperature for the capacitor is not exceeding the category temperature.

Polystyrene film/foil capacitors**2222 443**

Example : C = 20.000pF used for the following voltage signal

A sinewave signal with an a.c. voltage of 20V at 100kHz frequency.

The ambient temperature is 50°C.

Can a 20.000pF/63Vdc/25Vac be used for this application?

Checking the 5 conditions

1. The peak voltage $U_p = 28 (\sqrt{2} \times 20)$ is lower than 63Vdc.
2. The peak to peak voltage $56 U_{pp}$ is lower than 25Vac $2\sqrt{2} = 70 U_{pp}$
3. Pulse conditions : of no condensation.
4. The dissipated power is :

$$P = \omega \cdot C \cdot \tan_{\text{delta}} V^2 \quad (\tan_{\text{delta}} = 8 \cdot 10^{-4} \text{ from fig. 6})$$
$$= 2 \cdot \pi \cdot 100000 \cdot 20 \cdot 10^{-9} \cdot 8 \cdot 10^{-4} \cdot (20)^2 = 2,5 \text{mW}$$

This is less than 140mW at 50°C for its dimensions
10 x 10mm, seen in fig.8.

5. The free air ambient temperature is 50°C, and lower than 70°C.

Polystyrene film/foil capacitors

2222 443

1.4. Related documents

Generic specification : IEC 384-1

Sectional specification : IEC 384-7

1.5. Marking

The capacitors according to Fig. 1 or 4 are marked in black ink on the top with the following information :

- Capacitance in pF
- Capacitance tolerance F : $\pm 1\%$
- Rated voltage (63)
- Production date code according to IEC 62, clause 5
- Code for diëlectric material (KS)

Note

The earth side is indicated by a vertical line to the left of the 2 nd and 3 rd lines of marking, and, for capacitors according to fig. 1 by the bevelled corner.

Example : 100
 | F 63
 | ..KS

The capacitors according to Fig. 2 or 3 are marked in black ink on the top with the following information :

- Capacitance in pF
- Capacitance tolerance F : $\pm 1\%$
- Rated voltage (63)
- Manufacturer's type designation (443)
- Production date code according to IEC 62, clause 5
- Code for diëlectric material (KS)
- Manufacturer's identification symbol 

Note

The earth side is indicated by a vertical line to the left of the 2 nd, 3 rd and 4 th lines of marking, and by the bevelled corner.

Example : 100
 example : |  F63
 | 443
 | .. KS

Polystyrene film/foil capacitors

2222 443

The package containing the capacitors is marked as follows

Data on label SPQ and PQ
(example)

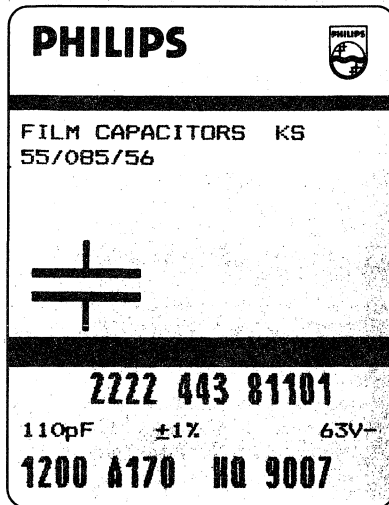

Block A : Philips word mark and emblem

Block B : Line 1 : Film capacitors and
material code
Line 2 : Climatic group number

Capacitor symbol

Block C : Line 1 : Product code (12 NC)

Line 2 : Capacitance value in pF or
 μ F followed by pF or μ F
Tolerance followed by + and %
Voltage followed by V-

Line 3 : Number of capacitors
Preference-origin code : A
Country of origin : Belgium=170
Responsible production centre :
Philips Roeselare = HQ
Production period : year- and
week code (4 digits)

Polystyrene film/foil capacitors

2222 443

1.6. Ordering information

Order the capacitors by quoting the 12-digit catalogue number as shown in Tables.

Composition of the catalogue number

2222 443

Multiplying factor

1 = 1X

2 = 10X

3 = 100X

First three figures of capacitance value in pF

	caps.	dimensions	lead length	fig.
3	100 tm 7500 pF	6,25 x 6,25	5 ⁺⁰ ₋₁	4
	100 tm 3920 pF	5 x 7,5	5 ⁺⁰ ₋₁	1
4	4020 tm 15000 pF	7,5 x 7,5	5 ⁺⁰ ₋₁	2
	15400 tm 34000 pF	10 x 10	5 ⁺⁰ ₋₁	3
	100 tm 3920 pF	5 x 7,5	3 ^{+0,4} ₋₀	1
6	4020 tm 15000 pF	7,5 x 7,5	3 ^{+0,4} ₋₀	2
	15400 tm 34000 pF	10 x 10	3 ^{+0,4} ₋₀	3
7	100 tm 3920 pF	7,5 x 7,5	3 ^{+0,4} ₋₀	2
8	100 tm 3920 pF	7,5 x 7,5	5 ⁺⁰ ₋₁	2

1.7. Certified test records (CTR)

Not required

Philips Components

Data sheet	
status	Product specification
date of issue	May 1990

2222 444/445/446/447

Polystyrene film/foil capacitors

KS Axial wrapped end-filled types

* supplied loose in box

QUICK REFERENCE DATA

Capacitance range	6200 to 162000pF
Capacitance tolerance	$\pm 5\%$, $\pm 2\%$, $\pm 1\%$
Rated voltage U_{Rdc}	63V, 160V, 250V, 630V
Climatic category	
63V version	40/070/56
160V, 250V, 630V versions	40/085/56
Rated temperature	
63V version	70°C
160V, 250V, 630V versions	85°C
Related specification	IEC 384-7
Stability class	Class 2

Polystyrene film/foil capacitors

2222 444/445/446/447

SURVEY OF STYLES

Style : 2222 444 to 447
See Tables 1 to 4

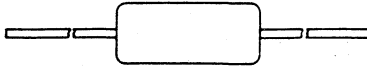

CONSTRUCTION

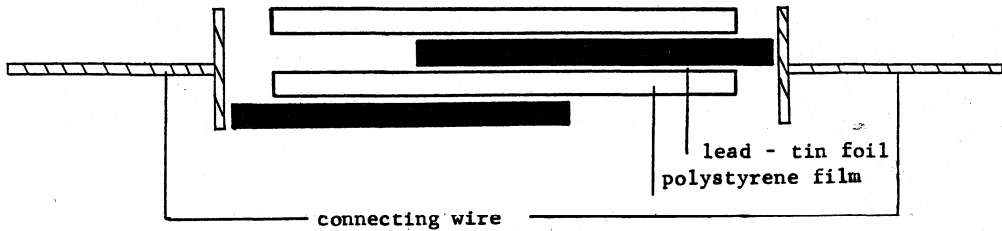

Polystyrene film/foil capacitors

2222 444/445/446/447

APPLICATION

For use in circuits where close tolerance, reliability and low losses are of prime importance, e.g. tuned circuits, filter networks, timing networks, etc.

DESCRIPTION

The capacitors consist of a low-inductive wound cell of metal foil and a polystyrene film. The cell is wrapped in a polyester film, the ends are filled with epoxy resin. The axial leads are of solder-coated wire.

1. GENERAL DATA

1.1. Mounting

The capacitors are suitable for vertical or horizontal mounting on printed-wiring boards and for point-to-point wiring.

Specific method of mounting to withstand vibration and shock

For case sizes up to and including a mass of 2 g. the capacitors shall be mechanically fixed by the leads. With larger case sizes the capacitors shall be mounted in the same way and the body shall be clamped.

Polystyrene film/foil capacitors

2222 444/445/446/447

1.2.1 Dimensions in mm

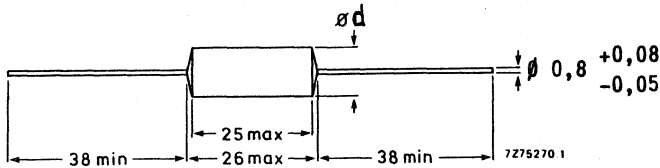

Fig. 1

Table 1 $U_{Rdc} = 63V$; max. a.c. voltage = 25V

Capacitance (E24-series, C-tol $\pm 5\%$)* pF	d_max	approx. mass g	catalogue number
43000	7,0	3,1	2222 444 24303
47000	7,5	3,2	24703
51000	7,5	3,4	25103
56000	8,0	3,7	25603
62000	8,5	4,0	26203
68000	8,5	4,4	26803
75000	9,0	4,7	27503
82000	9,5	5,1	28203
91000	9,5	5,5	29103
100000	10,0	5,9	21004
110000	10,5	6,4	21104
120000	11,0	6,9	21204
130000	11,5	7,5	21304
150000	12,0	8,2	21504
160000	12,5	9,0	21604
162000	12,5	9,1	21624

* The capacitance values quoted are also available with a tolerance $\pm 2\%$ or $\pm 1\%$.

Besides the values of the E24-series as quoted, intermediate values of the E48-series (with a tolerance $\pm 2\%$ or $\pm 1\%$) and of the E96-series (with a tolerance $\pm 1\%$) are available. The specifications of these intermediate values are equal to the specifications of the next higher value of the E24-series.

Polystyrene film/foil capacitors

2222 444/445/446/447

Table 2 $U_{Rdc} = 160V$; max. a.c. voltage = 63V, Fig. 1

rated capacitance (E24-series, C-tol $\pm 5\%$)* pF	d_max	approx. mass g	catalogue number
18000	6,5	2,3	2222 445 21803
20000	7,0	2,4	22003
22000	7,0	2,5	22203
24000	7,5	2,6	22403
27000	7,5	2,8	22703
30000	8,0	3,1	23003
33000	8,5	3,4	23303
36000	8,5	3,8	23603
39000	9,0	4,1	23903
43000	9,5	4,4	24303
47000	9,5	4,7	24703
51000	10,0	5,1	25103
56000	10,5	5,5	25603
62000	11,0	5,9	26203
68000	11,5	6,4	26803
75000	12,0	7,0	27503
82000	12,5	7,6	28203

Table 3 $U_{Rdc} = 250V$; max. a.c. voltage = 125V, Fig. 1

rated capacitance (E24-series, C-tol $\pm 5\%$)* pF	d_max	approx. mass g	catalogue number
12000	7,0	2,1	2222 446 21203
13000	7,0	2,2	21303
15000	7,5	2,4	21503
16000	7,5	2,5	21603
18000	8,0	2,7	21803
20000	8,5	2,9	22003
22000	8,5	3,2	22203
24000	9,0	3,5	22403
27000	9,5	3,7	22703
30000	10,0	4,0	23003
33000	10,5	4,4	23303
36000	10,5	4,7	23603
39000	11,0	5,1	23903
43000	11,5	5,5	24303
47000	12,0	5,9	24703

* The capacitance values quoted are also available with a tolerance $\pm 2\%$ or $\pm 1\%$. Besides the values of the E24-series as quoted, intermediate values of the E48-series (with a tolerance $\pm 2\%$ or $\pm 1\%$) and of the E96-series (with a tolerance $\pm 1\%$) are available. The specifications of these intermediate values are equal to the specifications of the next higher value of the E24-series.

Polystyrene film/foil capacitors

2222 444/445/446/447

Table 4 $U_{Rdc} = 630V$; max. a.c. voltage = 250V, Fig. 1

Capacitance (E24-series, C-tol $\pm 5\%$)* pF	d_max	approx. mass g	catalogue number
6200	7,5	2,1	2222 447 26202
6800	7,5	2,2	26802
7500	8,0	2,4	27502
8200	8,0	2,6	28202
9100	8,5	2,8	29102
10000	9,0	3,0	21003
11000	9,0	3,3	21103
12000	9,5	3,6	21203
13000	10,0	3,9	21303
15000	10,5	4,2	21503
16000	11,0	4,6	21603
18000	11,5	4,9	21803
20000	12,0	5,3	22003
22000	12,5	5,8	22203
24000	12,5	6,2	22403

* The capacitance values quoted are also available with a tolerance $\pm 2\%$ or $\pm 1\%$.

Besides the values of the E24-series as quoted, intermediate values of the E48-series (with a tolerance $\pm 2\%$ or $\pm 1\%$) and of the E96-series (with a tolerance $\pm 1\%$) are available. The specifications of these intermediate values are equal to the specifications of the next higher value of the E24-series.

Polystyrene film/foil capacitors
2222 444/445/446/447

1.3.2 Packing

The capacitors are supplied loose in box, the quantity per box is given in the table below.

capacitance values (pF)				Number of capacitors per box	
63 V version	160 V version	250 V version	630 V version	SPQ	PQ
43000- 56000	18000-30000	12000-18000	6200- 8200	600	1800
62000- 91000	33000-47000	20000-27000	9100-12000	500	1500
100000-130000	51000-68000	30000-43000	13000-18000	400	1200
150000-162000	75000-82000	47000	20000-24000	300	900

Polystyrene film/foil capacitors**2222 444/445/446/447**

1.3. Ratings and characteristics

Unless otherwise specified all electrical values apply to an ambient free air temperature of $23 \pm 1^\circ\text{C}$, an atmospheric pressure of 86 to 106 kPa and a relative humidity of $50 \pm 2\%$.

1.3.1 Capacitance

Capacitance range at 1 kHz	see Tables 1 to 4
Capacitance tolerance	see Tables 1 to 4
Temperature coefficient	$-(125 \pm 60) \times 10^{-6}/\text{K}$
Capacitance dependance on frequency : none between 100 Hz and 1MHz	

Polystyrene film/foil capacitors

2222 444/445/446/447

1.3.2 Voltage

Rated voltage U_{Rdc}	see Tables 1 to 4
Category voltage U_C	U_{Rdc}
Test voltage	
between terminations	$2 \times U_{Rdc}$
between interconnected terminations and case (foil method)	$2 \times U_{Rdc}$; min. 400 V
Max. a.c. voltage (r.m.s. value), at 50 to 60 Hz	see Tables 1 to 4

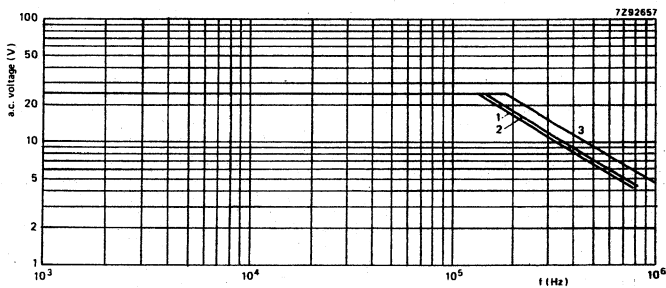

- 1 : 43000 pF
- 2 : 100000 pF
- 3 : 162000 pF

Fig. 2 Maximum a.c. voltage (r.m.s. value) as a function of frequency at $T_{amb} < 55^{\circ}C$, for $U_R = 63V$.

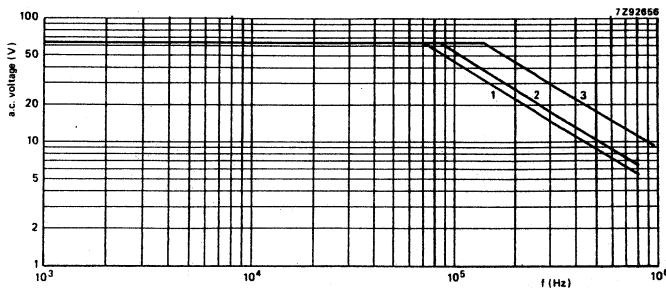

- 1 : 18000 pF
- 2 : 43000 pF
- 3 : 82000 pF

Fig. 3 Maximum a.c. voltage (r.m.s. value) as a function of frequency at $T_{amb} < 70^{\circ}C$, for $U_R = 160V$.

Polystyrene film/foil capacitors

2222 444/445/446/447

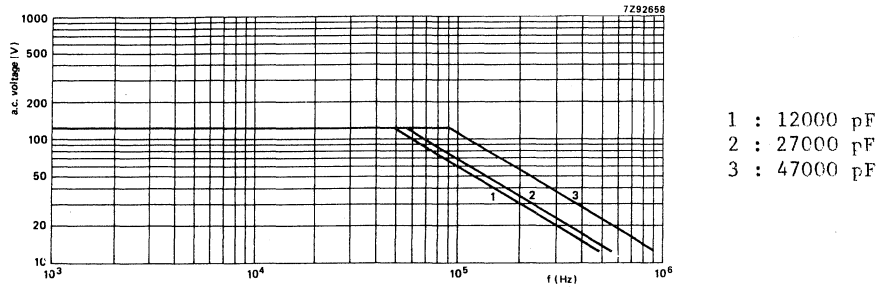

Fig. 4 Maximum a.c. voltage (r.m.s. value) as a function of frequency at $T_{amb} \leq 70^{\circ}C$, for $U_R = 250V$.

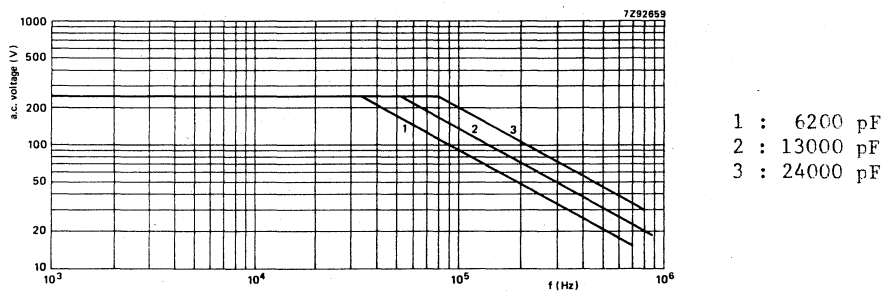

Fig. 5 Maximum a.c. voltage (r.m.s. value) as a function of frequency at $T_{amb} \leq 70^{\circ}C$, for $U_R = 630V$.

1.3.3 Climatic category

63V version
160V, 250V, 630V versions

40/070/56
40/085/56

1.3.4 Rated temperature

63V version
160V, 250V, 630V versions

-40 to +70°C
-40 to +85°C

1.3.5 Storage temperature range

Temperature -25°C to +40°C
RH max. 80% without condensation

Polystyrene film/foil capacitors

2222 444/445/446/447

1.3.6 Tangent of loss angle

capacitance	tangent of loss angle	
	at 1 kHz	at 100 kHz
6200 pF < C ≤ 10000 pF	< 5 × 10 ⁻⁴	< 10 × 10 ⁻⁴
10000 pF < C ≤ 20000 pF	< 5 × 10 ⁻⁴	< 15 × 10 ⁻⁴
C > 20000 pF	< 5 × 10 ⁻⁴	< 25 × 10 ⁻⁴

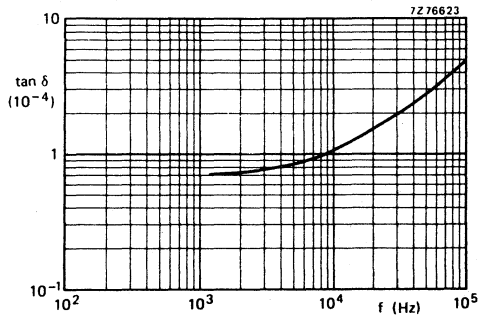

Fig. 6 : tan_delta as a function of frequency; typical curve

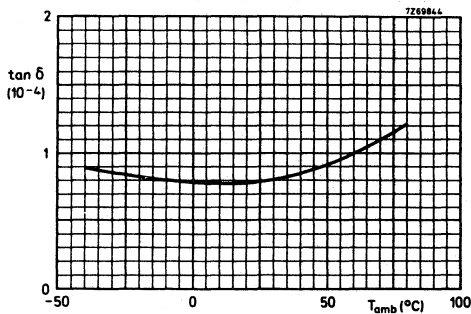

Fig. 7 : Tan_delta as a function of ambient free air temperature; typical curve

Polystyrene film/foil capacitors**2222 444/445/446/447**

1.3.7 Insulation resistance at $T_{amb} 20^{\circ}C$.

The insulation resistance is measured after a voltage has been applied for 1 min. \pm 5 s., the voltage being 10 \pm 1 V for the 63 V version 100 \pm 15 V for the 160 V and 250 V versions and 500 \pm 50 V for the 630 V version.

R between terminations $> 500.000 M\Omega$

R between interconnected terminations $> 500.000 M\Omega$
and case

Inductance $\leq 10nH/cm$ lead and cap. length

Polystyrene film/foil capacitors

2222 444/445/446/447

1.3.8 Maximum dissipation

The power dissipated by a capacitor is a function of the voltage U_{esr} across or the current I through the series resistance ESR and is expressed by:

$$P = \frac{U_{esr}^2}{ESR} \quad (1) \quad \text{or } P = ESR \cdot I^2 \quad (2)$$

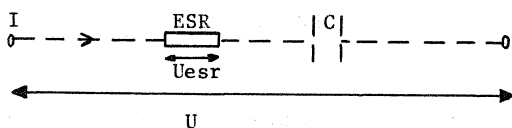

$$U_{esr}^2 = \frac{ESR^2}{ESR^2 + 1/\omega^2 C^2} \cdot U^2 \quad (3a)$$

As for film capacitors $\tan_{\delta} = \omega \cdot C \cdot ESR \ll 0.1$, the formula (3a) can be simplified to

$$U_{esr}^2 = ESR^2 \cdot \omega^2 \cdot C^2 \cdot U^2 \quad (3b)$$

or with $ESR = \tan_{\delta} / \omega C$, we become:

$$P = \omega \cdot C \cdot \tan_{\delta} \cdot U^2 \quad (4) \quad \text{or } P = \frac{\tan_{\delta}}{\omega \cdot C} I^2 \quad (5)$$

For the \tan_{δ} we can take the value found from fig.6, C is in farad and $\omega = 2 \cdot \pi \cdot f$.

U or I are assumed to be known.

The maximum permissible power dissipation (P_{max}), which depends on the dimensions of the capacitor and on the ambient free air temperature can be found from fig.8.

In applications where sine waves occur, we have to take for U the RMS-voltage or for I the RMS-current of the sine wave.

In applications where periodic signals occur, the signal has to be expressed in Fourier-terms:

$$U = U_0 + \sum_{k=1}^{\infty} \sin(k\omega t + \varphi_k) \quad (6)$$

Polystyrene film/foil capacitors

2222 444/445/446/447

$$I = \sum_{k=1}^{\infty} I_k \sin(k\omega t + \psi_k) \quad (7)$$

with U_0 the D.C.voltage, U_k and I_k the voltage resp. current of the k-th harmonic.

We become for the dissipated power :

$$\text{with (6)} \quad P = \sum_{k=1}^{\infty} k \cdot \omega \cdot C \cdot \tan_{\Delta k} \cdot \frac{U_k^2}{2} \quad (8)$$

$$\text{with (7)} \quad P = \sum_{k=1}^{\infty} \frac{\tan_{\Delta k} \cdot I_k^2}{k \cdot \omega \cdot C \cdot 2} \quad (9)$$

and $\tan_{\Delta k}$ is the \tan_{Δ} at the k-th harmonic.

curve	dimensions(mm)	
	d_max	l_max
1	6,5	25
2	7,0	
3	7,5	
4	8,0	
5	8,5	
6	9,0	
7	9,5	
8	10,0	
9	10,5	
10	11,0	
11	11,5	
12	12,0	
13	12,5	

Fig. 8 Maximum dissipation as a function of ambient free air temperature.

*At $T_{amb} < 70^{\circ}C$ ($< 55^{\circ}C$ for 63V version) the maximum permissible sinusoidal voltage can be found in figs. 2, 3, 4 and 5.

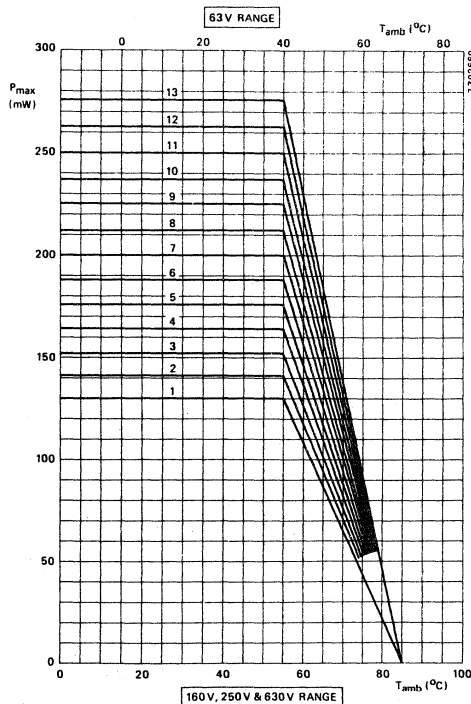

Polystyrene film/foil capacitors

2222 444/445/446/447

1.3.9 Application note

To select this capacitor for a certain application you have to check 5 conditions :

1. The peak voltage (U_p) shall not be greater than the rated d.c. voltage.
2. The peak to peak voltage (U_{pp}) shall not be greater than 2.V2 times the rated a.c. voltage, to avoid the ionisation inception level.
3. There is no limit for the peak current (I_p) or voltage pulse slope (dU/dt) in the application.
4. The dissipated power shall not be greater than the maximum permissible power dissipation stated in 1.3.8.
5. The free air ambient temperature for the capacitor is not exceeding the category temperature.

Polystyrene film/foil capacitors
2222 444/445/446/447

Example : C = 0,1 μ F used for the following voltage signal

A sinewave signal with an a.c. voltage of 20V at 100kHz frequency.

The ambient temperature is 50°C.

Can a 0,1 μ f/63Vdc/25Vac be used for this application?

Checking the 5 conditions

1. The peak voltage $U_p = 28$ ($V_2 \times 20$) is lower than 63Vdc.
2. The peak to peak voltage $56U_{pp}$ is lower than 25Vac $2V_2 = 70 U_{pp}$
3. Because of the sinewave, we have not to check the pulse conditions.
4. The dissipated power is :

$$P = W.C. \tan_{\Delta} V^2 \quad (\tan_{\Delta} = 5.10^{-4} \text{ from fig. 6})$$

$$= 2. \cdot 100000.0,1.10^{-6} 5.10^{-4} \cdot (20)^2 = 13mW$$

This is less than 212mW at 50°C for its dimensions
 $d_{\max} = 10mm$, seen in fig. 8.

5. The free air ambient temperature is 50°C, and lower than 70°C.

Polystyrene film/foil capacitors**2222 444/445/446/447**

1.4. Related documents

Generic specification	IEC 384-1
Sectional specification	IEC 384-7

1.5. Marking

The capacitors are marked in black ink on the top with the following information :

- Capacitance in pF or nF
- Capacitance tolerance (e.g. 1%)
- Rated voltage (e.g. 630V=)
- Code for dielectric material (KS)
- Manufacturer's type designation (e.g. 447)
- Production date code according to IEC 62, clause 5

The outer film connection is identified with a stroke.

Example : | 9n1 1%
 | 630V= KT
 | 447 ..

Polystyrene film/foil capacitors

2222 444/445/446/447

The package containing the capacitors is marked as follows

Data on label SPQ and PQ
(example)

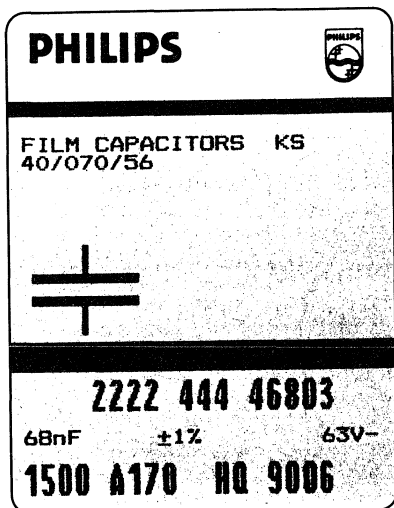

Block A : Philips word mark and emblem

Block B : Line 1 : Film capacitors and material code
Line 2 : Climatic group number

Capacitor symbol

Block C : Line 1 : Product code (12 NC)

Line 2 : Capacitance value
<10 K in nF followed by nF
>10K in µF followed by µF
Tolerance followed by + and %
Voltage followed by V-

Line 3 : Number of capacitors
Preference-origin code : A
Country of origin : Belgium=170
Responsible production centre :
Philips Roeselare = HQ
Production period : year- and week code (4 digits)

1.6. Ordering information

Order the capacitors by quoting the 12-digit catalogue number as shown in Tables 1 to 4

Composition of the catalogue number

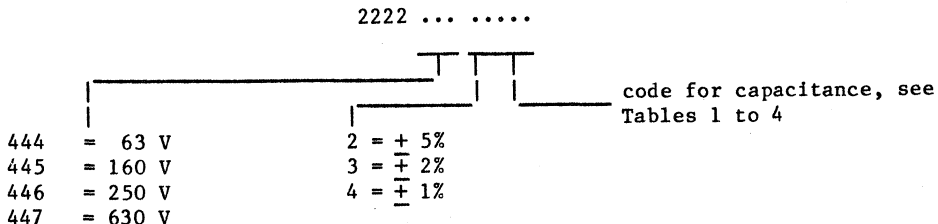

1.7. Certified test records (CTR)

Not required.

Philips Components

Data sheet	
status	Product specification
date of issue	May 1990

2222 341
Metallized polycarbonate
film capacitors

MKC Axial moulded type

° Supplied loose in box

QUICK REFERENCE DATA

Capacitance range (E12-series)	0,00082 to 6,8 μ F
Capacitance tolerance	<u>+20%</u> , <u>+10%</u> , <u>+5%</u>
Rated voltage U _{Rdc}	100V, 250V, 400V, 630V, 1000V, 1600V
Climatic category	55/100/56
Rated temperature	85°C
Tangent of loss angle at 10kHz	20 x 10 ⁻⁴
Related specification	IEC 384-6
Performance grade	Grade 2 (general purpose)

Metallized polycarbonate film capacitors

2222 341

SURVEY OF STYLES

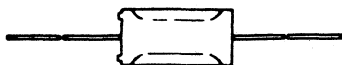

Style : 2222 341
See Tables 1 to 6

CONSTRUCTION

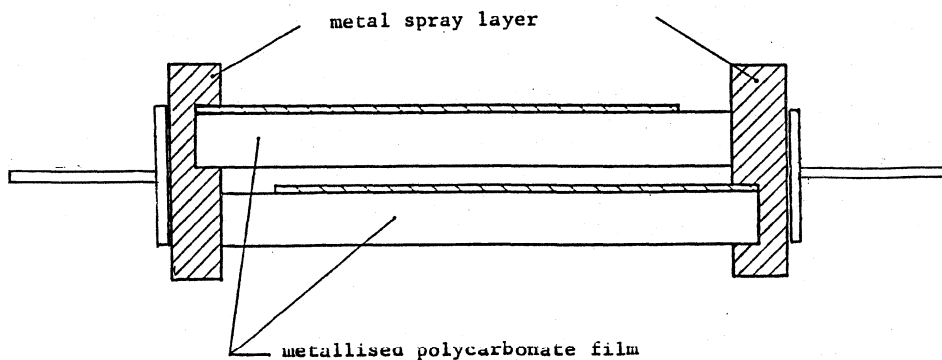

Metallized polycarbonate film capacitors

2222 341

APPLICATION

In electronic circuits for blocking and coupling, bypass and energy reservoir applications.

DESCRIPTION

The capacitors consist of a low-inductive wound cell of metallized polycarbonate film. The cell is moulded in yellow flame retardent polypropylene. The axial leads are of solder-coated wire. One end of the capacitor is provided with two stand-off ridges to allow removal of solder flux etc., when cleaning the printed-wiring board.

1. GENERAL DATA

1.1. Mounting

Normal use

The capacitors are designed for horizontal or vertical mounting on printed-wiring boards and for point to point wiring.

Specified method of mounting to withstand vibration and shock

In order to withstand vibration and shock tests, it must be ensured that the capacitor body is in good contact with the printed-wiring board.

For case sizes up to and including a mass of 6g. the capacitor shall be mechanically fixed by the leads.

With larger case sizes the capacitor shall be mounted in the same way and the body shall be clamped.

Metallized polycarbonate film capacitors

2222 341

1.2.1 Dimensions in mm

All dimensions are given in mm.

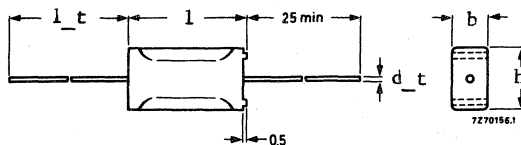
Table 1 $U_{Rdc} = 100V$; max. a.c. voltage = 63V

capacitance μF	b_{max} mm	h_{max} mm	l_{max} mm	d_t mm	l_t min mm	mass g	catalogue number 2222 341		
							C-tol $\pm 20\%$	C-tol $\pm 10\%$	C-tol $\pm 5\%$
0,082							28823	29823	23823
0,10							28104	29104	23104
0,12	5,1	8,8	14,6			1,0	28124	29124	23124
0,15							28154	29154	23154
0,18	5,7	9,5	14,6			1,1	28184	29184	23184
0,22	7	10,6	14,6			1,4	28224	29224	23224
0,27							28274	29274	23274
0,33	6,6	10,4	18,1	0,8	40	1,7	28334	29334	23334
0,39							28394	29394	23394
0,47	7,9	11,5	18,1			2,0	28474	29474	23474
0,56							28564	29564	23564
0,68	7,8	11,6	23,5			2,5	28684	29684	23684
0,82							28824	29824	23824
1,0	9,2	12,9	23,5			3,2	28105	29105	23105
1,2							28125	29125	23125
1,5	10,8	14,5	23,5			4,0	28155	29155	23155
1,8							28185	29185	23185
2,2	10,7	14,6	31			5,5	28225	29225	23225
2,7							28275	29275	23275
3,3	12,5	19,5	31	1	50	8,0	28335	29335	23335
3,9							28395	29395	23395
4,7							28475	29475	23475
5,6	15,4	22,1	31			10,5	28565	29565	23565
6,8							28685	29685	23685

Metallized polycarbonate film capacitors

2222 341

Table 2 $U_{Rdc} = 250V$; max. a.c. voltage = 160V, Fig. 1

capacitance μF	b_max mm	h_max mm	l_max mm	d_t mm	l_t_min mm	mass g	catalogue number 2222 341		
							C-tol $\pm 20\%$	C-tol $\pm 10\%$	C-tol $\pm 5\%$
0,039							48393	49393	47393
0,047							48473	49473	47473
0,056	5,1	8,8	14,6			1,0	48563	49563	47563
0,068							48683	49683	47683
0,082	5,7	9,5	14,6			1,4	48823	49823	47823
0,10							48104	49104	47104
0,12	6,6	10,4	18,1			1,7	48124	49124	47124
0,15							48154	49154	47154
0,18	7,9	11,5	18,1	0,8	40	2,0	48184	49184	47184
0,22							48224	49224	47224
0,27	7,8	11,6	23,5			2,5	48274	49274	47274
0,33							48334	49334	47334
0,39	9,2	12,9	23,5			3,2	48394	49394	47394
0,47							48474	49474	47474
0,56	10,8	14,5	23,5			4,0	48564	49564	47564
0,68							48684	49684	47684
0,82	10,7	14,6	31			5,5	48824	49824	47824
1,0							48105	49105	47105
1,2	12,5	19,5	31			8,0	48125	49125	47125
1,5				1	50		48155	49155	47155
1,8	15,4	22,1	31			10,5	48185	49185	47185
2,2							48225	49225	47225

Metallized polycarbonate film capacitors

2222 341

Table 3 U_{Rdc} = 400V; max. a.c. voltage = 220V, Fig. 1

capacitance pF, μ F	b _{max} mm	h _{max} mm	l _{max} mm	d _t mm	l _t min mm	mass g	catalogue number 2222 341		
							C-tol + 20%	C-tol + 10%	C-tol + 5%
8200pF							58822	59822	57822
0,010 μ F							58103	59103	57103
0,012							58123	59123	57123
0,015	5,1	8,8	14,6			1,0	58153	59153	57153
0,018							58183	59183	57183
0,022							58223	59223	57223
0,027							58273	59273	57273
0,033	5,7	9,5	14,6			1,1	58333	59333	57333
0,039	7	10,6	14,6	0,8	40	1,4	58393	59393	57393
0,047							58473	59473	57473
0,056	6,6	10,4	18,1			1,7	58563	59563	57563
0,068							58683	59683	57683
0,082	7,9	11,5	18,1			2,0	58823	59823	57823
0,10							58104	59104	57104
0,12	7,8	11,6	23,5			2,5	58124	59124	57124
0,15							58154	59154	57154
0,18	9,2	12,9	23,5			3,2	58184	59184	57184
0,22							58224	59224	57224
0,27	10,8	14,5	23,5			4,0	58274	59274	57274
0,33							58334	59334	57334
0,39	10,7	14,6	31			5,5	58394	59394	57394
0,47							58474	59474	57474
0,56	12,5	19,5	31	1	50	8,0	58564	59564	57564
0,68							58684	59684	57684
0,82	15,4	22,1	31			10,5	58824	59824	57824
1,0							58105	59105	57105

Metallized polycarbonate film capacitors

2222 341

Table 4 $U_{Rdc} = 630V$; max. a.c. voltage = 220V, Fig. 1

capacitance pF, μF	b_max mm	h_max mm	l_max mm	d_t mm	l_t min mm	mass g	catalogue number 2222 341		
							C-tol $\pm 20\%$	C-tol $\pm 10\%$	C-tol $\pm 5\%$
8200pF	5,1	8,8	14,6	0,8	40	1,0	60822	61822	62822
0,010 μF	5,7	9,5	14,6			1,1	60103	61103	62103
0,012						60123	61123	62123	
0,015						60153	61153	62153	
0,018						60183	61183	62183	
0,022	7	10,6	14,6			1,4	60223	61223	62223
0,027	6,6	10,4	18,1			1,7	60273	61273	62273
0,033	7,9	11,5	18,1			2,0	60333	61333	62333
0,039						60393	61393	62393	
0,047						60473	61473	62473	
0,056	7,8	11,6	23,5			2,5	60563	61563	62563
0,068	9,2	12,9	23,5			3,2	60683	61683	62683
0,082						60823	61823	62823	
0,10						60104	61104	62104	
0,12						60124	61124	62124	
0,15	10,8	14,5	23,5	4,0	60154	61154	62154		
0,18	10,7	14,6	31	1	50	5,5	60184	61184	62184
0,22	12,5	19,5	31			8,0	60224	61224	62224
0,27						60274	61274	62274	
0,33	15,4	22,1	31			10,5	60334	61334	62334
0,39						60394	61394	62394	
0,47						60474	61474	62474	

Metallized polycarbonate film capacitors

2222 341

Table 5 $U_{Rdc} = 1000V$; max. a.c. voltage = 250V, Fig. 1

capacitance pF, μF	b _{max} mm	h _{max} mm	l _{max} mm	d _t mm	l _t min mm	mass g	catalogue number 2222 341		
							C-tol + 20%	C-tol + 10%	C-tol + 5% *
8200pF	6,6	10,4	18,1	0,8	40	1,7	70822	71822	72822
0,010 μF						70103	71103	72103	
0,012						70123	71123	72123	
0,015	7,9	11,5	18,1			2,0	70153	71153	72153
0,018	7,8	11,6	23,5			2,5	70183	71183	72183
0,022						70223	71223	72223	
0,027	9,2	12,9	23,5			3,2	70273	71273	72273
0,033						70333	71333	72333	
0,039						70393	71393	72393	
0,047	10,8	14,5	23,5			4,0	70473	71473	72473
0,056	10,7	14,6	31	1	50	5,5	70563	71563	72563
0,068						70683	71683	72683	
0,082	12,5	19,5	31			8,0	70823	71823	72823
0,10						70104	71104	72104	
0,12						70124	71124	72124	
0,15	15,4	22,1	31			10,5	70154	71154	72154

+ 5 %

* available on request

Metallized polycarbonate film capacitors

2222 341

Table 6 $U_{Rdc} = 1600V$; max. a.c. voltage = 250V, Fig. 1

capacitance pF, μF	b_max mm	h_max mm	l_max mm	d_t mm	l_t min mm	mass g	catalogue number 2222 341	
							C-tol $\pm 20\%$	C-tol $\pm 10\%$
820pF	5,7	9,5	14,6	0,8	40	1,1	80821	81821
1000						80102	81102	
1200						80122	81122	
1500	7	10,6	14,6			1,4	80152	81152
1800							80182	81182
2200							80222	81222
2700	6,6	10,4	18,1			1,7	80272	81272
3300							80332	81332
3900							80392	81392
4700							80472	81472
5600	7,9	11,5	18,1	2,0	80562	81562		
6800						80682	81682	
8200	7,8	11,6	23,5			2,5	80822	81822
0,010 μF							80103	81103
0,012	9,2	12,9	23,5			3,2	80123	81123
0,015							80153	81153
0,018							80183	81183
0,022	10,8	14,5	23,5			4,0	80223	81223
0,027	10,7	14,6	31	1	50	5,5	80273	81273
0,033						80333	81333	
0,039	12,5	19,5	31			8,0	80393	81393
0,047							80473	81473
0,056							80563	81563
0,068	15,4	22,1	31			10,5	80683	81683

Metallized polycarbonate film capacitors

2222 341**1.2.2 Packing**

The capacitors are supplied loose in box; the quantity per box is given in the table below.

h _{max} mm	Number of cap. per box	
	SPQ	PQ
< 11,6	250	1000
> 11,6	200	1000

Metallized polycarbonate film capacitors

2222 341

1.3 Ratings and characteristics

Unless otherwise specified all electrical values apply to an ambient free air temperature of $23 \pm 1^\circ\text{C}$, an atmospheric pressure of 86 to 106 kPa and a relative humidity of $50 \pm 2\%$.

1.3.1 Capacitance

Capacitance range at 1 kHz see Tables 1 to 6

Capacitance tolerance see Tables 1 to 6

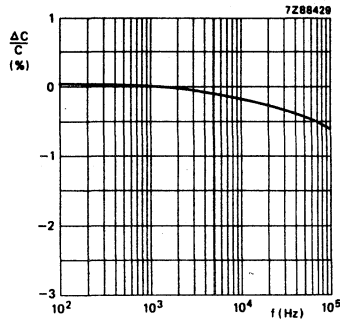

Fig. 2 : Capacitance as a function of frequency; typical curve.

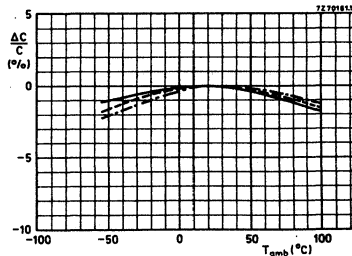

Fig. 3 : Capacitance as a function of ambient free air temperature; typical curves.

- for all capacitance values, measured at 1kHz, 1V.
- for capacitance values $\leq 1\mu\text{F}$, measured at 10kHz, 1V.
- .-.-.-.- for capacitance values $\leq 0,1\mu\text{F}$, measured at 100kHz, 0,3V.

Metallized polycarbonate film capacitors

2222 341**1.3.2 Voltage**

Rated voltage U_{Rdc}	see Tables 1 to 6
Category voltage U_C	$0,8 \times U_{Rdc}$
Test voltage between terminations between interconnected terminations and case(foil method)	$1,6 \times U_{Rdc}$ $2 \times U_{Rdc}$; min. 200V
Max a.c. voltage (r.m.s. value) at 50 to 60 Hz	see Tables 1 to 6

1.3.3 Climatic category

55/100/56

1.3.4 Rated temperature

85°C

1.3.5 Storage temperature range

Temperature -25°C to 40°C

Metallized polycarbonate film capacitors

2222 341

1.3.6 Tangent of loss angle

Capacitance	Tangent of loss angle		
	1kHz	10kHz	100kHz
$C < 0,1\mu\text{F}$	$< 30 \times 10^{-4}$	$< 60 \times 10^{-4}$	$\leq 130 \times 10^{-4}$
$0,1\mu\text{F} < C \leq 1\mu\text{F}$	$\leq 30 \times 10^{-4}$	$\leq 60 \times 10^{-4}$	
$C > 1\mu\text{F}$	$\leq 30 \times 10^{-4}$	$\leq 75 \times 10^{-4}$	

Fig. 4 : Tan delta as a function of frequency, typical curve

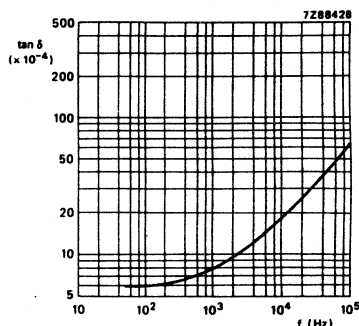

1.3.7 Maximum pulse load ($\frac{dU}{dt}$) R

Rated voltage V	Maximum pulse load (V/ μs)			
	l=14,5mm	l=18mm	l=23,5mm	l=31mm
100	30	13	7,5	4,5
250	45	18	12	7
400	70	30	18	11
630	100	45	25	15
1000		45	40	20
1600	225	125	60	30

The maximum pulse load values in the table are valid for pulse voltages equal to the rated voltage.

For lower pulse voltages the given values may be multiplied by U_R /applied voltage.

Metallized polycarbonate film capacitors

2222 341

1.3.8 Insulation resistance at T_{amb} . 20°C

The insulation resistance is measured after a voltage has been applied for 1 min. \pm 5 s., the voltage being 100V \pm 15V for the 100V, 250V and 400V versions and 500V \pm 50V for the 630V, 1000V and 1600V versions.

R between terminations, for $C \leq 0,33\mu\text{F}$

100V versions	> 15 000 $\text{M}\Omega$
250V, 400V, 630V, 1000 and 1600V versions	> 30 000 $\text{M}\Omega$

RC between terminations, for $C > 0,33\mu\text{F}$

100V versions	> 5 000 s
250V, 400V, 630V, 1000 and 1600V versions	> 10 000 s

R between interconnected terminations and case > 30 000 $\text{M}\Omega$
(foil method)

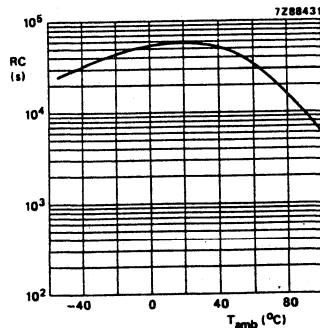

Fig. 5 : RC-product as a function of ambient free air temperature; typical curve

Metallized polycarbonate film capacitors

2222 341

1.3.9 Maximum dissipation

The power dissipated by a capacitor is a function of the voltage U_{esr} across or the current I through the series resistance ESR and is expressed by:

$$P = \frac{U_{esr}^2}{ESR} \quad (1) \quad \text{or } P = ESR \cdot I^2 \quad (2)$$

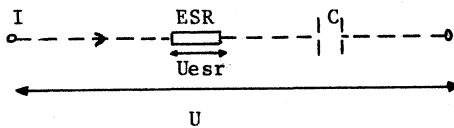

$$U_{esr}^2 = \frac{ESR^2}{ESR^2 + 1/w^2 C^2} \cdot U^2 \quad (3a)$$

As for film capacitors $\tan_{\Delta} = w.C.ESR \ll 0.1$, the formula (3a) can be simplified to

$$U_{esr}^2 = ESR^2 \cdot w^2 \cdot C^2 \cdot U^2 \quad (3b)$$

or with $ESR = \tan_{\Delta}/wC$, we become:

$$P = w.C.\tan_{\Delta}.U^2 \quad (4) \quad \text{or } P = \frac{\tan_{\Delta}}{w.C} I^2 \quad (5)$$

For the \tan_{Δ} we can take the value found from fig.4, C is in farad and $w = 2\pi.f$.

U or I are assumed to be known.

The maximum permissible power dissipation (P_{max}), which depends on the dimensions of the capacitor and on the ambient free air temperature can be found from fig.6.

In applications where sine waves occur, we have to take for U the RMS-voltage or for I the RMS-current of the sine wave.

In applications where periodic signals occur, the signal has to be expressed in Fourier-terms:

$$U = U_0 + \sum_{k=1}^{\infty} \sin(kwt + \varphi_k) \quad (6)$$

Metallized polycarbonate film capacitors

2222 341

$$I = \sum_{k=1}^{\infty} I_k \sin(k\omega t + \varphi_k) \quad (7)$$

with U_0 the D.C.voltage, U_k and I_k the voltage resp. current of the k-th harmonic.

We become for the dissipated power :

$$\text{with (6)} \quad P = \sum_{k=1}^{\infty} k \cdot \omega \cdot C \cdot \tan_{\Delta k} \frac{U_k^2}{2} \quad (8)$$

$$\text{with (7)} \quad P = \sum_{k=1}^{\infty} \frac{\tan_{\Delta k} \cdot I_k^2}{k \cdot \omega \cdot C \cdot 2} \quad (9)$$

and $\tan_{\Delta k}$ is the \tan_{Δ} at the k-th harmonic.

Curve	Dimensions (mm)		
	b_max	h_max	l_max
1	5,1	8,8	14,6
2	5,7	9,5	14,6
3	7	10,6	14,6
4	6,6	10,4	18,1
5	7,9	11,5	18,1
6	7,8	11,6	23,5
7	9,2	12,9	23,5
8	10,8	14,5	23,5
9	10,7	14,6	31
10	12,5	19,5	31
11	15,4	22,1	31

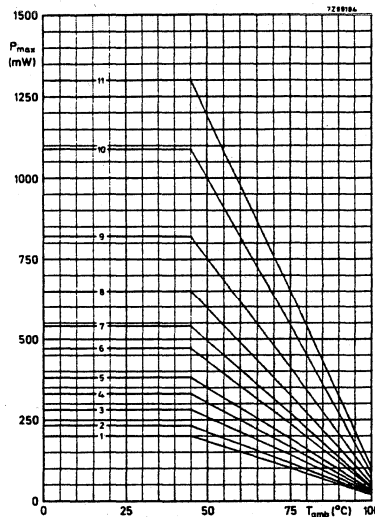

Fig. 6 Maximum permissible power dissipation as a function of ambient free air temperature

1.3.10 Application note

To select this capacitor for a certain application you have to check 6 condition

1. The peak voltage (U_p) shall not be greater than the rated d.c. voltage.
2. The peak to peak voltage (U_{pp}) shall not be greater than $2\sqrt{2}$ times the rated a.c. voltage to avoid the ionisation inception level.
3. The peak current (I_p) shall not exceed the maximum peak current, defined as maximum voltage pulse slope (dU/dt) multiplied by the capacitance.

$$I_p \text{ max} = C \left(\frac{dU}{dt} \right) \text{ max.}$$

Or the voltage pulse slope shall not exceed the rated voltage pulse slope.
If the pulse voltage is lower than the rated voltage, the values of tabel 1.3 may be multiplied by U_{Rdc} and divided by applied voltage.

4. The dissipated power shall not be greater than the maximum permissible power dissipation stated in 1.3.9.
5. The free air ambient temperature for the capacitor is not exceeding the category temperature.
6. Since all metallised film capacitors have always intrinsically active flammability risk, it is recommended to use these capacitors only in these circuits where in case of failure of the capacitor the power can be limited to less than 5 VA to the capacitor.

Metallized polycarbonate film capacitors

2222 341

Example of using Fig. 4 and 6.

A capacitor of $1\mu\text{F}$ should be used at a sine voltage of 130 Vrms, a frequency of 1 kHz and an ambient free air temperature of 50°C .

Is it possible to use a $1\mu\text{F}/250\text{V}$?

Checking the 6 conditions

1. The peak voltage $U_p = 183 (\sqrt{2} \times 130)$ is lower than 250Vdc.
2. The peak to peak voltage $367U_{pp}$ is lower than 160Vac $2\sqrt{2} = 452 U_{pp}$.
3. Because of the sinewave, we have not to check the pulse conditions.
4. The dissipated power is :

$$P = W.C. \tan_{\text{delta}} V^2 \quad (\tan_{\text{delta}} = 8.10^{-4} \text{ from fig. 4})$$
$$= 2.7.1000.1.10^{-6} 8.10^{-4} .(130)^2 = 85\text{mW}$$

This is less than 595mW at 50°C for its dimensions
10,7 x 14,6 x 31 seen in fig. 6.

5. The free air ambient temperature is 50°C , and lower than 100°C .
6. In case of failure, the power is switched off.

Metallized polycarbonate film capacitors

2222 341

1.4. Related documents

Generic specification	IEC 384-1
Sectional specification	IEC 384-6

1.5 Marking

The capacitors are marked by impression on one side with the following information :

- Capacitance in pF or μ F
- Capacitance tolerance (e.g. 10)
- Rated voltage (e.g. 400)
- Manufacturer's type designation (341)
- Code for dielectric material (MKC)
- Production date code acc. to IEC-62, clause 5

Example : |0.27/10/400
 |341 MKC ..

The capacitors are also marked by impression on the other side with the following information :

- Manufacturer's name (PHILIPS)
- Code for factory of origin (HQ)

Example : PHILIPS
 HQ

Metallized polycarbonate film capacitors

2222 341

The package containing the capacitors is marked as follows

Data on label of SPQ and PQ
(example)

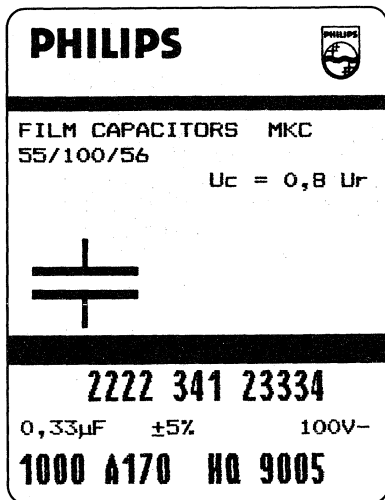

Block A : Philips word mark and emblem

Block B : Line 1 : Film capacitors and material code
Line 2 : Climatic category number and category voltage

Capacitor symbol

Block C : Line 1 : Product code (12 NC)

Line 2 : Capacitance value in μF followed by μF
Tolerance followed by \pm and %
Voltage followed by V-

Line 3 : Number of capacitors
Preference-origin code : A
Country of origin : Belgium=170
Responsible production centre : Philips Roeselare = HQ
Production period : year- and week code (4 digits)

1.6. Ordering information

Order the capacitors by quoting the 12-digit catalogue number as shown in Tables 1 to 3.

1.7. Certified test records (CTR)

Not required.

SUPPORT MATERIAL

In addition to this book, we have further support material on film capacitors such as **designers' sample boxes** for quick design-in of a film capacitor into your application.

To order this and other support material, please contact your local sales organization from the address list shown on the back cover of this Databook.

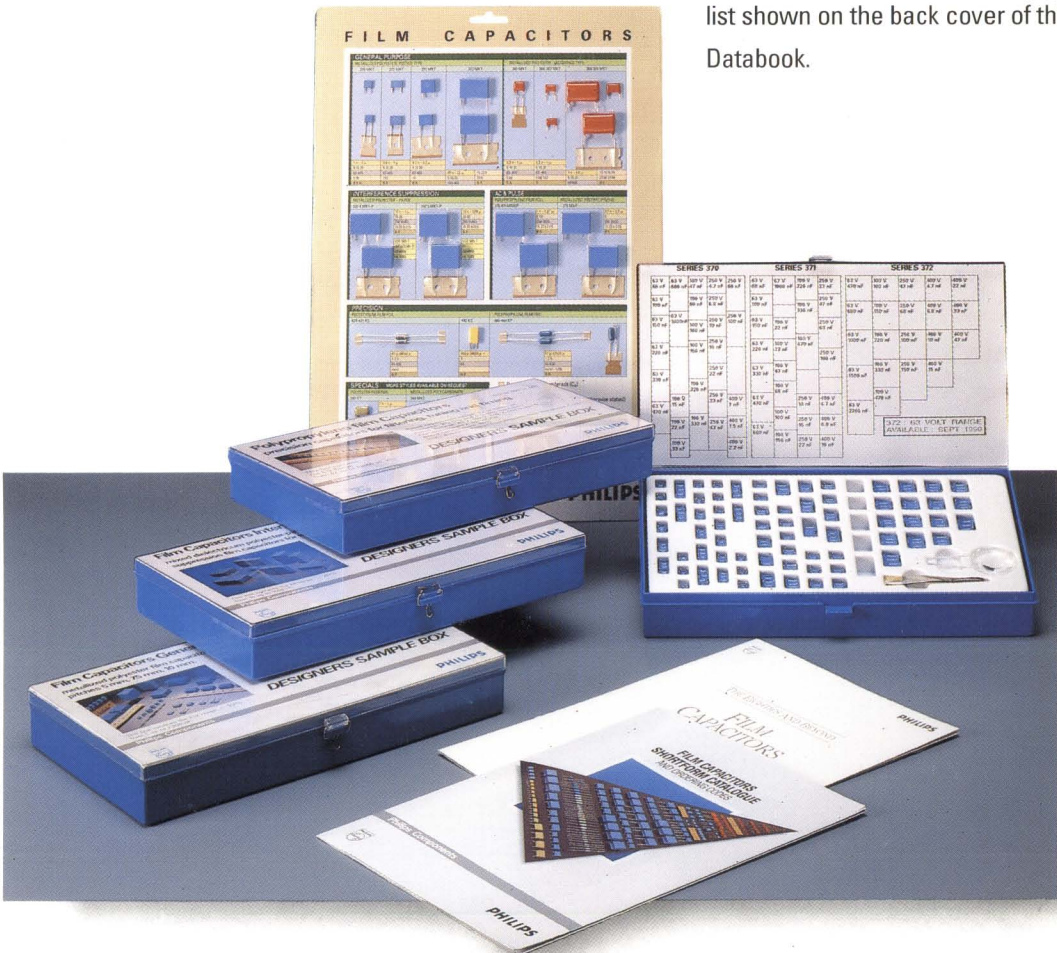

Philips Components – a worldwide company

Argentina: PHILIPS ARGENTINA S.A., Div. Philips Components, Vedia 3892, 1430 BUENOS AIRES, Tel. (01)541-4261.

Australia: PHILIPS COMPONENTS PTY Ltd, 11 Waltham Street, ARTARMON, N.S.W. 2064, Tel. (02)4393322.

Austria: ÖSTERREICHISCHE PHILIPS INDUSTRIE G.m.b.H., UB Bauelemente, Triester Str. 64, 1101 WIEN, Tel. (0222)60 101-820.

Belgium: N.V. PHILIPS PROF. SYSTEMS – Components Div., 80 Rue Des Deux Gares, B-1070 BRUXELLES, Tel. (02)52 56 111.

Brazil: PHILIPS COMPONENTS (Active Devices) Av. das Nacoes Unidas, 12495-SAO PAULO-SP, CEP 04578, P.O. Box 7383, Tel. (011)534-2211.

PHILIPS COMPONENTS (Passive Devices & Materials)
Av. Francisco Monteiro 702, RIBEIRAO PIRES-SP,
CEP 09400, Tel. (011)459-8211.

Canada: PHILIPS ELECTRONICS LTD., Philips Components, 601 Milner Ave., SCARBOROUGH, Ontario, M1B 1M8, Tel. (416) 292-5161.
(IC Products) SIGNETICS CANADA LTD., 1 Eva Road, Suite 411, ETOBICOKE, Ontario, M9C 4Z5, Tel. (416) 626-6676.

Chile: PHILIPS CHILENA S.A., Av. Santa Maria 0760, SANTIAGO, Tel. (02) 77 38 16.

Colombia: IPRELENZO LTDA., Carrera 21 No. 56-17, BOGOTA, D.E., P.O. Box 77621, Tel. (01) 249 76 24.

Denmark: PHILIPS COMPONENTS A/S, Prags Boulevard 80, PB1919, DK-2300 COPENHAGEN 5, Tel. 01-54 11 33.

Finland: PHILIPS COMPONENTS, Sinikallontie 3, SF-2630 ESPOO, Tel. 358-0-50 261.

France: PHILIPS COMPOSANTS, 117 Quai du Président Roosevelt, 92134 ISSY-LES-MOULINEAUX Cedex, Tel. (01) 40 93 80 00.

Germany (Fed. Republic): PHILIPS COMPONENTS UB der Philips G.m.b.H., Valvo Haus, Burckhardstrasse 19, D-2 HAMBURG 1, Tel. (040) 3296-0.

Greece: PHILIPS HELLENIQUE S.A., Components Division, No. 15, 25th March Street, GR 17778 TAVROS, Tel. (01) 4894 339/4894911.

Hong Kong: PHILIPS HONG KONG LTD., Components Div., 15/F Philips Ind. Bldg., 24-28 Kung Yip St., KWAI CHUNG, Tel. (0)-42 45 121.

India: PEICO ELECTRONICS & ELECTRICALS LTD., Components Dept., Band Box Building, 254-D Dr. Annie Besant Rd., BOMBAY – 400025, Tel. (022) 49 30 311/49 30 590.

Indonesia: P.T. PHILIPS-RALIN ELECTRONICS, Components Div., Setiabudi II Building, 6th Fl., Jalan H.R. Rasuna Said (P.O. Box 223/KBY) Kuningan, JAKARTA 12910, Tel. (021) 51 79 95.

Ireland: PHILIPS ELECTRONICS (IRELAND) LTD., Components Division, Newstead, Clonskeagh, DUBLIN 14, Tel. (01) 69 33 55.

Italy: PHILIPS S.p.A., Philips Components, Piazza IV Novembre 3, I-20124 MILANO, Tel. (02) 6752.1.

Japan: PHILIPS JAPAN LTD., Components Division, Philips Bldg 13-37, Kohnan 2-chome, Minato-ku, TOKYO 108, Tel. (03) 740-5028.

Korea (Republic of): PHILIPS ELECTRONICS (KOREA) LTD., Components Division, Philips House, 260-199 Itaewon-dong, Yongsan-ku, SEOUL, Tel. (02) 794-5011.

Malaysia: PHILIPS MALAYSIA SDN BHD, Components Div., 3 Jalan SS15/2A SUBANG, 47500 PETALING JAYA, Tel. (03) 73 45 511.

Mexico: PHILIPS COMPONENTS, Paseo Triunfo de la Republica, No 215 Local 5, Cd Juarez CHI HUA HUA 32340 MEXICO, Tel. (16) 18-67-01/02.

Netherlands: PHILIPS NEDERLAND B.V., Marktgroep Philips Components, Postbus 90050, 5600 PB EINDHOVEN, Tel. (040) 78 37 49.

New Zealand: PHILIPS NEW ZEALAND LTD., Components Division, 110 Mt. Eden Road, C.P.O. Box 1041, AUCKLAND, Tel. (09) 605-914.

Norway: NORSK A/S PHILIPS, Philips Components, Box 1, Manglerud 0612, OSLO, Tel. (02) 68 02 00.

Pakistan: PHILIPS ELECTRICAL CO. OF PAKISTAN LTD., Philips Markaz, M.A. Jinnah Rd., KARACHI-3, Tel. (021) 7257 72.

Peru: CADESA, Carretera Central 6.500, LIMA 3, Apartado 5612, Tel. 51-14-35 00 59.

Philippines: PHILIPS INDUSTRIAL DEV. INC., 2246 Pasong Tamo, P.O. Box 911, Makati Comm. Centre, MAKATI-RIZAL 3116, Tel. (02) 868951 to 59.

Portugal: PHILIPS PORTUGUESA S.A.R.L., Av. Eng. Duarte Pacheco 6, 1009 LISBOA Codex, Tel. (019) 68 31 21.

Singapore: PHILIPS SINGAPORE, PTE LTD., Components Div., Lorong 1, Toa Payoh, SINGAPORE 1231, Tel. 35 02 000.

South Africa: S.A. PHILIPS PTY LTD., Components Division, JOHANNESBURG 2000, P.O. Box 7430.

Spain: PHILIPS COMPONENTS, Balmes 22, 08007 BARCELONA, Tel. (03) 301 63 12.

Sweden: PHILIPS COMPONENTS, A.B., Tegeluddsvägen 1, S-11584 STOCKHOLM, Tel. (018) 78 21 000.

Switzerland: PHILIPS A.G., Components Dept., Allmendstrasse 140-142, CH-8027 ZÜRICH, Tel. (01) 488 22 11.

Taiwan: PHILIPS TAIWAN LTD., 581 Min Sheng East Road, P.O. Box 22978, TAIPEI 10446, Taiwan, Tel. 886-2-5005899.

Thailand: PHILIPS ELECTRICAL CO. OF THAILAND LTD., 283 Silom Road, P.O. Box 961, BANGKOK, Tel. (02) 233-6330-9.

Turkey: TÜRK PHILIPS TICARET A.Ş., Philips Components, Talatpasa Cad. No. 5, 80640 LEVENT/İSTANBUL, Tel. (01) 179 27 70.

United Kingdom: PHILIPS COMPONENTS LTD., Mullard House, Torrington Place, LONDON WC1E 7HD, Tel. (01) 580 6633.

United States: (Colour picture tubes – Monochrome & Colour Display Tubes) PHILIPS DISPLAY COMPONENTS COMPANY, 1600 Huron Parkway, P.O. Box 963, ANN ARBOR, Michigan 48106, Tel. 313/996-9400.
(IC Products) SIGNETICS CORPORATION, 811 East Arques Avenue, SUNNYVALE, CA 94088-3409, Tel. (408) 991-2000.
(Passive Components, Discrete Semiconductors, Materials and Professional Components) PHILIPS COMPONENTS, Discrete Products Division, 2001 West Blue Heron Blvd., P.O. Box 10330, RIVIERA BEACH, Florida 33404, Tel. (407) 981-3200.

Uruguay: PHILIPS COMPONENTS, Coronel Mora 433, MONTEVIDEO, Tel. (02) 70-40 44.

Venezuela: MAGNETICA S.A., Calle 6, Ed. Las Tres Jotas, CARACAS 1074A, App. Post. 78117, Tel. (02) 241 75 09.

Zimbabwe: PHILIPS ELECTRICAL (PVT) LTD., 62 Mutare Road, HARARE, P.O. Box 994, Tel. 47211.

For all other countries apply to: Philips Components Division, Strategic Accounts and International Sales, P.O. Box 218, 5600 MD EINDHOVEN, The Netherlands, Telex 35000 phtnl, Fax. 23753

AS80 © Philips Export B.V. 1990

All rights are reserved. Reproduction in whole or in part is prohibited without the prior written consent of the copyright owner.

The information presented in this document does not form part of any quotation or contract, is believed to be accurate and reliable and may be changed without notice. No liability will be accepted by the publisher for any consequence of its use. Publication thereof does not convey nor imply any license under patent- or other industrial or intellectual property rights.

Printed in The Netherlands

9398 172 00011

Philips Components



PHILIPS